

**NATIONAL**

# **SHOOTING SPORTS**

**MANUAL**

## Acknowledgments

The Boy Scouts of America greatly appreciates the National Shooting Sports committee and sub-task force members for their expertise and recommendations in the development of the *Boy Scouts of America National Shooting Sports Manual*.

The BSA would also like to acknowledge the longstanding relationship with the National Rifle Association (NRA) in the goal of training youth and adults in the safe use of firearms.

The BSA would like to acknowledge the relationship with USA Archery for the relationship in developing and training youth and adults in safe archery experiences.

## THE BSA'S COMMITMENT TO SAFETY

In Scouting, we will not compromise the safety of our youth, volunteers, and employees. Safety is a value that must be taught and reinforced at every opportunity. We are all responsible and must hold each other accountable to provide a safe environment for all participants.

We are committed to abuse prevention by utilizing:

- Mandatory youth protection training.
- Criminal background checks.
- Banning one-on-one adult and youth interactions.
- Mandatory reporting of suspected abuse to law enforcement.
- A volunteer screening database.

We are committed to injury and illness prevention by integrating safety measures in our handbooks, literature, and training materials including the *Guide to Safe Scouting*. We expect leaders to use the four points of **SAFE** when delivering the program. **SAFE** Scouting measures include:

- Youth are **Supervised** by qualified and trustworthy adults who set the example for safety.
- Activities are **Assessed** for risks.
- Pre-requisite **Fitness** and **skill** levels are confirmed before participation.
- Appropriate **Equipment** is utilized and **Environmental** conditions are monitored.

When incidents do occur, we expect a timely, clear, and complete incident report. We are committed to learning from the data and modifying program guidance for the prevention of future occurrence.



## INTRODUCTION

The Purpose of BSA shooting sports is to introduce youth to shooting. The BSA shooting programs are based on age appropriateness and safety with the goal of developing a positive shooting experience for each youth.

While safety is paramount, it should be noted that with all shooting sports activities there is inherent risk involved. The BSA follows the SAFE practices and requires all ranges to have approved Standard Operating Procedures (SOP) that are approved for that range. Range supervision and instruction are overseen by qualified staff with a key focus of scout safety.

The BSA's National Shooting Sports Committee understands the need for clarification in the terminology and delivery of the BSA shooting sports programs. This manual contains all BSA shooting sports activities and provides guidance for their implementation in Scouting. No other shooting sports are authorized at this time. Information on approved firearms, ranges, qualified supervision, training requirements, targets, and ammunition is included.

Updates of this manual between printings will be available at [www.scouting.org/outdoorprograms](http://www.scouting.org/outdoorprograms) under the "Shooting Sports" tab.



## Scouting is SAFE – Shooting and Throwing Sports

The Boy Scouts of America adheres to its longstanding policy of teaching its youth and adult members the safe, responsible, and intelligent handling, care, and use of firearms, archery and hand-held throwing sports in planned, carefully managed, and supervised programs. Safety during shooting sports must remain top of mind.

### Supervision

Youth are supervised by qualified and trustworthy adults who set the example for safety. Supervision includes:

- Range Management - a range safety position(s) who oversee the shooting stations and participants.
- Instruction – participants with the right demeanor, skills, abilities and validated credentials to teach safety and develop the participant’s ability at that activity.
- During live fire, range safety positions and instructors may be supplemented by coaches, registered leaders, and even parents and partners to support a safe experience for participants.
- Cub Scout Shooting Sports are only conducted and supervised by local Councils.

### Assessment

Activities are assessed for risks during planning. Leaders have reviewed applicable program guidance or standards and have verified the activity is not prohibited. Risk avoidance or mitigation is incorporated into the activity. Assessment includes:

- Validating shooting or throwing sports are age-appropriate for the participants being served.  
<https://filestore.scouting.org/filestore/HealthSafety/pdf/680-685.pdf>
- Ranges are located on local Council properties, and Standard Operating Procedures for each venue are available, fitting the discipline, equipment, and ammunition being used.
- If private ranges are used by older youth programs, the local shooting sports committee, an appointed NRA Chief Range Safety Officer and the Scout Executive has reviewed and approved the location and Standard Operating Procedures. “Private Property Approval for Shooting Sports by Units, Districts, and Councils” form can be found at <https://www.scouting.org/outdoor-programs/shooting-sports/>
- Verification of state and local laws regarding shooting sports are followed.

### Fitness and Skill

Participants’ Annual Health and Medical Records are reviewed, and leaders have confirmed that prerequisite fitness and skill levels exist for participants to take part safely. This includes:

- An instructor reviewing participant’s ability (with or without accommodations) to safely operate the device, firearm, or bow, or throwing object.
- Participants have received the appropriate on-site safety briefing before participation including the three rules of firearm safety.

### Equipment and Environment

Safe and appropriately sized equipment, courses, camps, campsites, trails, or playing fields are used correctly. Leaders periodically check gear use and the environment for changing conditions that could affect safety. This includes:

- Before any use, and periodically, all equipment (shooting devices, firearms, bows, slingshots, hawks, knives, target frames or targets, etc.) should be inspected by a range supervision and instruction and qualified gunsmiths or archery retailer.
- Safe and Secure Storage and transportation for Firearms, Ammunition, Bows, etc.
- Personal Protective Equipment for all participants and observers is available and used as required. Including:
  - Eye protection
  - Hearing protection
  - Armguards
  - Finger Tabs or finger savers
  - Appropriate attire



# CONTENTS

## **SECTION I THE ESSENTIALS**

<b>Chapter 1: Qualified Supervision—Roles and Responsibilities</b> .....	9
Introduction to Shooting Sports and the Positive Aspects .....	9
Shooting Sports Personnel Descriptions .....	9
Definition of “Instructor Qualified” .....	10
Five Levels of Shooting Activities .....	17
<b>Chapter 2: BSA Shooting Sports—A Wealth of Year-Round Opportunities</b> .....	25
Cub Scout Programs .....	25
Scouts BSA Programs .....	25
Venturing and Sea Scout Programs .....	25
<b>Chapter 3: Merit Badge Counselors</b> .....	27
Shooting Sports Merit Badge Counselor Requirements and Registration .....	27
Resources for Merit Badge Counselors .....	27

## **SECTION II BEYOND THE UNIT LEVEL**

<b>Chapter 4: Council Shooting Sports Committees</b> .....	31
Organization .....	31
Responsibilities .....	31
<b>Chapter 5: Range Operation</b> .....	33
General Equipment Common to All Scouting Program Levels and Shooting Disciplines .....	33
Range and Shooting Equipment Appropriate to Each Scouting Program Level .....	34

## **SECTION III HEALTH AND SAFETY**

<b>Chapter 6: Safety</b> .....	41
Communications .....	41
Emergency Response Plans .....	41
National Camping Standards .....	41
Standard Operating Procedures .....	41
Equipment Inspections—Firearms and Archery .....	41
<b>Chapter 7: Additional Considerations</b> .....	41
General .....	41

## **SECTION IV TRAINING**

<b>Chapter 8: Training Courses</b> .....	45
BSA Training .....	45
National Rifle Association Training .....	45
Archery Training .....	46

## **SECTION V ARCHERY AND BB GUNS FOR CUB SCOUTS**

<b>Chapter 9: Introduction</b> .....	51
Leadership .....	51
Directing Shooting Sports in a Council Program .....	74
Safety Instruction Guidelines .....	74
Positive Aspects of Shooting Sports .....	74

## SECTION VI OTHER SHOOTING SPORTS FOR ALL PROGRAM LEVELS

<b>Chapter 10: Other Shooting Sports for All Program Levels</b> .....	77
Shooting on a Safe Range .....	77
Pellet Guns .....	77
Slingshots and Wrist-Braced Slingshots.....	77
Catapults and Other Shooting Devices.....	79
Sporting Arrows and Flash Ball .....	79
Tomahawk and Knife Throwing.....	80
<b>Chapter 11: Resources, Certificates, and Patches</b> .....	85
Resources.....	85
Sample Archery Scorecard .....	87
Sample Targets .....	88
Crossword Puzzle: Air Gun Shooting .....	89
Quiver and Bow Rack .....	90
Archery Storage Locker .....	91
Glossary.....	95

## APPENDICES

1 NRA FIRST Steps/BSA Shotgun Shooting Merit Badge Teaching Guide.....	101
2 NRA FIRST Steps/BSA Rifle Shooting Merit Badge Teaching Guide .....	109
3 Sample Standard Operating Procedures Manual .....	117
4 Shooting Sports Decision Tree .....	121
5 Activity Consent Form, No. 680-673 .....	122
6 Cub Scout and Webelos Scout BB Gun Shooting Sports .....	123
Training Archery Rangemasters .....	125
Training BB Gun Rangemasters .....	126
7 Private Property Approval for Shooting Sports by Units, Districts, and Councils.....	127
8 Prohibited Activities .....	127
9 Open Shooting Archery Experience .....	129
10 Instructional Archery Experience .....	133
11 Scouting Pistol Safety & Marksmanship.....	137
12 Multigun Airsoft Experience .....	141
13 Chalk Ball Program Guide.....	155
14 Cowboy Action Shooting Program Guide .....	165
15 Instructional Rifle Shooting Experience.....	177
16 Open Rifle Shooting Experience .....	183
17 Instructional Shotgun Experience.....	189
18 Open Shotgun Shooting Experience.....	195
19 Sporting Arrows.....	201
20 Cub Scout Shooting Sports Guide .....	203
21 Resources .....	245





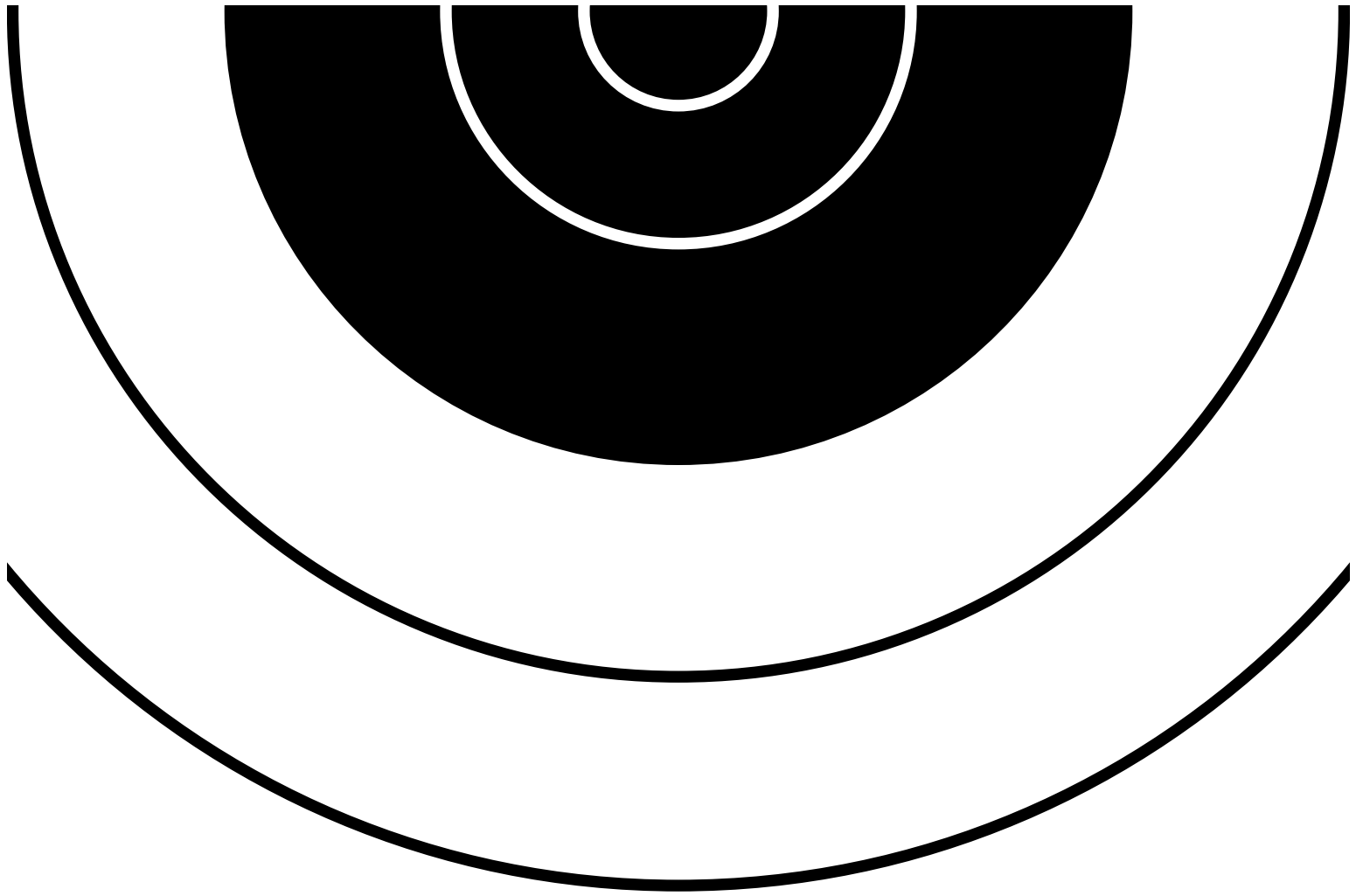

## SECTION I THE ESSENTIALS

The information in Section I is essential for everyone involved in BSA shooting sports programs. This includes all individuals working with Cub Scouting, Scouts BSA, Venturing, Sea Scouting, or shooting sports committees.



# CHAPTER 1: QUALIFIED SUPERVISION—ROLES AND RESPONSIBILITIES

## Introduction to Shooting Sports and the Positive Aspects

Throughout the Boy Scouts of America from Cub Scouting to Venturing and Sea Scouting, all programs use responsible outdoor activities to promote character development and values-based leadership training. Shooting sports have the ability to attract and retain youth in the movement. Millions of young people participate in one or more of the sports annually—archery, rifle shooting, shotgun activities, etc.—guided by adults who have the skills and knowledge to provide quality programs in a safe and effective way.

Key to safe and effective unit activities is informed, trained, and conscientious unit leadership. Various activities can present some degree of risk; those risks can be mitigated by training and commitment of BSA volunteer leaders. When activities are properly conducted under the appropriate guidelines, they can be safe, fun filled, exciting, and rewarding.

The Cubmaster, Scoutmaster, Crew Advisor, Skipper, or other registered adult leader in charge, who accompanies the unit on an outing, is always responsible for ensuring that all activities adhere to the age appropriate guidelines of the BSA and follow the program design of the BSA. However, BSA policy does not specify that the unit leader must be the one to satisfy all the criteria for supervision of specific program activities.

For Shooting Sports, the unit leader may or may not hold specified certification(s) for the supervision of the range and in the case of Cub Scouting, shooting sports is not approved for a unit activity.

There are two main aspects of shooting sports range supervision:

1. Range Management – Those individuals who are in charge of range safety and overseeing the shooting stations and participants. These people are responsible for following the approved Standard Operating Procedures (SOP) for the range and overall range supervision. This person is the safety officer.

2. Range Instruction – Those individuals whose primary concern is instruction in the type of shooting, referred to as a shooting discipline. This person is responsible to train in the proper use of and care for the equipment being used. This person may instruct BSA advancement or recognition pieces. Their main responsibility is to instruct and foster competency in the participant.

This publication provides information to determine when the proper safeguards are in place for a shooting activity, regardless of whether those safeguards are provided by the facility operator or the unit. Skills and

certifications are reviewed, as well as requirements for a proper facility. After reviewing this material, the leader should be confident in their ability to judge when a shooting activity is safe, when the risk is unacceptable, or when their background is insufficient to make that determination. Experienced, informed leaders develop a sense or intuition regarding an action. When an activity exceeds the leader's comfort zone, it should be curtailed or modified.

## Shooting Sports Personnel Descriptions

### Shooting Sports Director

- Twenty-one years of age or older and currently certified with National Camping School shooting sports director training within the past five years.
- In charge of all shooting sports programs, including rifle, shotgun, muzzleloaders, throwing sports and archery during the summer camp program.
- Manages staff that includes properly qualified instructors with current certifications and trains support staff.
- Sees that all areas are maintained and used properly, keeps an updated inventory of equipment, and is in charge of the safe and proper maintenance and use of this equipment.
- Can serve as a Range Safety Officer if the National Camping School certified shooting sports director holds current NRA Range Safety Officer Certification.
- Can serve as an NRA Instructor if the National Camping School shooting sports director holds current NRA Instructor certifications for the discipline for which supervision and instruction is required.

### NRA Certified Instructor

- Twenty-one years of age or older. Current NRA Instructor rating in the specific shooting sports program for which supervision and instruction is required. The National Camping School shooting sports director can be the NRA Instructor.

### NRA Assistant Instructors

- Eighteen years of age or older and holds current NRA assistant instructor's certificate in the appropriate discipline
- Can assist the NRA Instructor in supervising a range; however, this does not include running a live firing line.

### **NRA Range Safety Officer**

- Twenty-one years of age or older and holds current NRA Range Safety Officer credentials
- In charge of the firing line at any time it is in operation
- May not leave the firing line at any time while it is in operation

### **Shooting Sports Program Counselors and Aides**

- Sixteen years of age or older and trained for specific duties by a National Camping School shooting sports director
- Under on-site supervision of an NRA Range Safety Officer, may exercise crowd control, serve as training assistant for specified topics assigned by the NRA Range Safety Officer, move and maintain equipment, and act as a coach in a student coach/pupil setting
- May NOT supervise any live fire

### **BSA BB Gun Rangemaster**

- Eighteen years of age or older and trained by a National Camping School shooting sports director or National Rifle Association rifle instructor
- Is in charge of the firing line at any time it is in operation
- BB gun training must be renewed every two years, and this person must have a current Training Course Certificate, No. 33767

### **BSA Archery Director**

- 18 years of age or older
- An Archery Rangemaster who is trained by a National Camping School shooting sports director or is instructor certified by the USA Archery using USA Archery Level 1 instructor course by a USA Archery Level 2 Instructor Trainer or a National Camping School shooting sports director or a USA Level 1 Archery Instructor and would receive a Rangemaster certification.
- Responsibilities include the setup and operation of a safe archery range for Cub Scout, Scouts BSA, Venturing or Sea Scouting programs, Archery merit badge instruction, and management of an archery staff at camp.

### **BSA Archery Rangemaster**

- Eighteen years of age or older and trained by a National Camping School shooting sports director or USA Archery Level 1 Archery Instructor to set up and operate a safe archery range for a Cub Scouts, Scouts BSA, Venturing or Sea Scouting archery program according

to BSA standards located in Section V of this manual, “Archery and BB Guns.”

- Archery training must be renewed every two years, and this person must have a current Training Course Certificate, No. 33767.

### **Council Shooting Sports Coordinator/Chair**

- 21 years old or older. National Camping School certification as a shooting sports director is recommended.
- National Rifle Association certified instructor for one or more of the appropriate disciplines is recommended.
- Current NRA Range Safety Officer certification is recommended.
- USA Archery Level 1 Archery Instructor certification recommended.

### **Definition of “Instructor Qualified”**

**To be instructor qualified means the individual holds one or more of the following certifications depending on the discipline.**

Trained and currently documented by:

- The BSA National Camping School as a shooting sports director for rifle, shotgun, co-op muzzleloading rifle, and archery.
- The National Rifle Association as a currently certified instructor for the specific discipline where instruction is taking place (rifle, shotgun, pistol, co-op muzzleloading rifle, or NRA/NMLRA muzzleloading instructor)
- USA Archery as a currently certified USA Archery Level 1 instructor or higher.

A copy of the current training certificate or document is to be on file at the local council office and/or camp.

The following Chart describes the disciplines for BSA programs, and the supervision required to operate these programs. All shooting sports programs must follow the guidelines of the guide to safe scouting and the age appropriate guidelines of the BSA.



Program	Participants	Safety equipment	Minimum program supervision requirements	Qualified staff to open the range	Minimum number of staff to operate	Ratio instructor : participant	Additional information
BB (BSA Accredited Camp)*	All program levels <i>except</i> Lions	Eye Protection	BB gun Rangemaster	BB Gun Rangemaster National Camping School shooting Sports Director NRA Rifle Instructor Certified Military shooting instructor** Certified Law Enforcement Shooting Instructor** Certified 4-H Shooting Instructor**	1 qualified staff and appropriate assistants	1:1 adult to participant for Tiger Cubs 1:8 all others	Cub Scout participation at District or Council events ONLY
BB (Unit Activity)	Scouts BSA, Venturing, Sea Scouting	Eye protection	BB gun Rangemaster	BB Gun Rangemaster National Camping School shooting Sports Director NRA Rifle Instructor	1 qualified staff and appropriate assistants	1:8	Not approved as a Cub Scout Pack activity
Slingshot (BSA Accredited Camp)*	All program levels	Eye Protection	BB gun Rangemaster	BB Gun Rangemaster National Camping School shooting Sports Director NRA Rifle Instructor Certified Military shooting instructor** Certified Law Enforcement Shooting Instructor** Certified 4-H Shooting Instructor**	1 qualified staff and appropriate assistants	1:1 adult to participant for Cub Scout (all levels) 1:4 adult to participant Scouts BSA, Venturing, Sea Scouting	Cub Scout participation at District or Council events ONLY
Slingshot (Unit Activity)	Scouts BSA, Venturing, Sea Scouting	Eye Protection	BB gun Rangemaster	BB Gun Rangemaster National Camping School shooting Sports Director NRA Rifle Instructor	1 qualified staff and appropriate assistants	1:4 adult to participant	Not approved as a Cub Scout Pack activity
Pellet Rifles	Scouts BSA, Venturing, Sea Scouting, Webelos (Long-term Camp)	Eye Protection	NRA Rifle Instructor	National Camping School shooting Sports Director NRA Rifle Instructor Certified Military shooting instructor** Certified Law Enforcement Shooting Instructor** Certified 4-H Shooting Instructor**	1 qualified staff and appropriate assistants	1:8	Webelos Scouts may use pellet rifles on a council operated range while attending a long-term camp  All pellet rifles (CO2, pump, break barrel, etc.) are limited to singleshot, designated for target shooting, velocity of 500 to 540 feet per second, with a minimum of 2.5 pound trigger pull.  see also Multigun Airsoft Experience Operations Guide (p. 89) for additional operational guidance.

\*BSA accredited camp means, Day Camp, Short-term Camp and Long-term camp following the NCAP standards. If a council or district has a day activity, standards for “unit activity” apply. Unless otherwise stated the supervision standard is the same for a camp or unit activity. | \*\*Requires approved waiver. In addition, if these positions are used, these individuals need to also be familiar with and follow the program outlined in the Cub Scout Shooting sports guide located in chapter 23 of this manual. | † Required waiver for long-term camp only

Program	Participants	Safety equipment	Minimum program supervision requirements	Qualified staff to open the range	Minimum number of staff to operate	Ratio instructor : participant	Additional information
Rifle (BSA Accredited Camp)	Scouts BSA, Venturing, Sea Scouting	Eye and hearing protection	NRA Rifle Instructor	National Camping School shooting Sports Director NRA Rifle Instructor† Certified Military shooting instructor** Certified Law Enforcement Shooting Instructor** Certified 4-H Shooting Instructor**	Long-term camp: 1 qualified staff and appropriate assistants Short-term camp and Day Camp: NCS shooting Sports Director (1 person) OR NRA Rifle instructor AND NRA RSO (2 people)	1:8	See also current NCAP standards
Rifle (Unit activity)	Scouts BSA, Venturing, Sea Scouting	Eye and hearing protection	NRA Rifle Instructor AND NRA Range Safety Officer	National Camping School shooting Sports Director NRA Rifle Instructor AND NRA Range Safety Officer	2 people (RSO and at least one instructor)	1:8	
Shotgun (BSA Accredited Camp)	Scouts BSA, Venturing, Sea Scouting	Eye and hearing protection	NRA Shotgun Instructor	National Camping School shooting Sports Director NRA Shotgun Instructor† Certified Military shooting instructor** Certified Law Enforcement Shooting Instructor** Certified 4-H Shooting Instructor**	Long-term camp: 1 qualified staff and appropriate assistants Short-term camp and Day Camp: NCS shooting Sports Director (1 person) OR NRA Shotgun instructor AND NRA RSO (2 people)	1:6 for instruction 1:1 when loading and firing	Instructor maintains control of ammunition See also current NCAP standards

\*BSA accredited camp means, Day Camp, Short-term Camp and Long-term camp following the NCAP standards. If a council or district has a day activity, standards for “unit activity” apply. Unless otherwise stated the supervision standard is the same for a camp or unit activity. | \*\*Requires approved waiver | † Required waiver for long-term camp only

Program	Participants	Safety equipment	Minimum program supervision requirements	Qualified staff to open the range	Minimum number of staff to operate	Ratio instructor : participant	Additional information
Shotgun (Unit Activity)	Scouts BSA, Venturing, Sea Scouting	Eye and hearing protection	NRA Shotgun Instructor AND NRA Range Safety Officer	National Camping School shooting Sports Director NRA Shotgun Instructor AND NRA Range Safety Officer	2 people (RSO and at least one instructor)	1:6 for instruction 1:1 when loading and firing	Instructor maintains control of ammunition
Scouting Pistol and Marksmanship Program (BSA 8th grade), Venturing, Sea Scouting programs only)	Scouts BSA (14 or 13 and completed 8th grade), Venturing, Sea Scouting	Eye and hearing protection	2 individuals with NRA Pistol Instructor plus Scouting Pistol Marksmanship training certification One of whom is also an NRA RSO.	2 individuals with NRA Pistol Instructor plus Scouting Pistol Marksmanship training certification One of whom is also an NRA RSO.	2 individuals with NRA Pistol Instructor plus Scouting Pistol Marksmanship training certification One of whom is also an NRA RSO.	1:6 for instruction 1:2 when loading and firing	Council must apply to operate this activity
Pistols (unit activity)	Venturing, Sea Scouting	Eye and hearing protection	NRA Pistol Instructor AND NRA Range Safety Officer	NRA Pistol Instructor AND NRA Range Safety Officer	2 people (RSO and at least one instructor)	1:6 for instruction 1:2 when loading and firing	
Muzzleloading Rifle (BSA accredited Camp)	Scouts BSA, Venturing, Sea Scouting	Eye and hearing protection	NRA Co-Op Muzzleloading Rifle Instructor	National Camping School shooting sports director with current NRA Co-Op muzzleloading rifle instructor certification OR NRA/NMLRA certified muzzleloading instructor	Long-term camp: 1 qualified staff and appropriate assistants. Short-term camp and Day Camp: NCS shooting Sports Director with current NRA Co-Op Muzzleloading rifle instructor certification (1 person) OR NRA/NMLRA certified Muzzleloading instructor AND NRA RSO (2 people)	1:8 for instruction 1:1 when loading and firing	
Muzzleloading Rifle (Unit Activity)	Scouts BSA, Venturing, Sea Scouting	Eye and hearing protection	NRA Co-Op Muzzleloading Rifle Instructor AND NRA RSO (2 people)	National Camping School shooting sports director with current NRA Co-Op muzzleloading rifle instructor certification OR NRA/NMLRA certified muzzleloading instructor	2 people (RSO and at least one instructor)	1:8 for instruction 1:1 when loading and firing	
Muzzleloading shotgun (BSA accredited camp)	Scouts BSA, Venturing, Sea Scouting	Eye and hearing protection	NRA/NMLRA certified muzzleloading instructor	NRA/NMLRA certified muzzleloading instructor	Long term camp: 1 qualified staff and appropriate assistants Short-term camp and Day Camp: 1 qualified staff and appropriate assistants AND NRA RSO.	1:6 for instruction 1:1 when loading and firing	
Muzzleloading shotgun (unit activity)	Scouts BSA, Venturing, Sea Scouting	Eye and hearing protection	NRA/NMLRA certified muzzleloading instructor AND NRA RSO (2 people)	NRA/NMLRA certified muzzleloading instructor	2 people (RSO and at least one instructor)	1:6 for instruction 1:1 when loading and firing	

Program	Participants	Safety equipment	Minimum program supervision requirements	Qualified staff to open the range	Minimum number of staff to operate	Ratio instructor : participant	Additional information
Muzzleloading pistol (BSA accredited camp)	Venturing, Sea Scouting	Eye and hearing protection	NRA/NMLRA certified muzzleloading instructor	NRA/NMLRA certified muzzleloading instructor	long term camp: 1 qualified staff and appropriate assistants Short-term camp and Day Camp: 1 qualified staff and appropriate assistants AND NRA RSO.	1:6 for instruction 1:1 when loading and firing	
Muzzleloading pistol (unit activity)	Venturing, Sea Scouting	Eye and hearing protection	NRA/NMLRA certified muzzleloading instructor AND NRA RSO	NRA/NMLRA certified muzzleloading instructor AND NRA RSO	2 people (RSO and at least one instructor)	1:3 for instruction 1:1 when loading and firing	
Archery (BSA Accredited Camp)	All program levels	Arm guards on bow arm, finger protection	Archery Rangemaster	Archery Rangemaster for Cub Scout; OR USA Archery Level 1	1 qualified staff and appropriate assistants	1:8	
Archery (unit activity)	Scouts BSA, Venturing, Sea Scouting	Arm guards on bow arm, finger protection	USA Archery Level 1 or higher	USA Archery Level 1 or higher	1 qualified staff and appropriate assistants	1:8	
Tomahawks/ knives	Scouts BSA, Venturing, Sea Scouting	Eye protection	Responsible adult (18+) familiar with the use of tomahawk/knife throwing	Responsible adult (18+) familiar with the use of tomahawk/knife throwing	1 qualified staff and appropriate assistants	1:4	Activity must be approved by a council Shooting Sports Chair or National Camping School Shooting Sports Director.
Catapults (see catapults in chapter 10)	All program levels (as appropriate)	Eye protection	NRA Range Safety Officer				Activity must be approved by council SS Chair or National Camping School SS Director
Chalkball/ Paintball (BSA accredited Camp programs only)	Scouts BSA, Venturing, Sea Scouting	Eye and hearing protection	NRA Range Safety Officer	NRA RSO	1 qualified staff and appropriate assistants	1:1	See also Chalkball Shooting Program Guide, page 103 Council must apply to operate this activity
Multi-gun Airsoft experience	Scouts BSA, Venturing, Sea Scouting	Eye Protection	BB Gun Rangemaster with Airsoft endorsement Coach (authorized by airsoft instructor) Volunteer (as needed for event)	BB Gun Rangemaster with Air Soft endorsement National Camping School shooting Sports Director NRA Rifle Instructor with Airsoft endorsement	2 qualified staff and appropriate assistants	1:1 1 Instructor per bay 1 Coach per bay	See also Multi-gun Airsoft Experience Operations Guide. Chapter 15, page 89. Airsoft endorsement is conducted through the council Shooting sports committee. Council must apply to operate this activity

Program	Participants	Safety equipment	Minimum program supervision requirements	Qualified staff to open the range	Minimum number of staff to operate	Ratio instructor : participant	Additional information
Sporting arrows (BSA accredited Camp programs only)	Scouts BSA, Venturing, Sea Scouting	Arm guards on bow arm, finger protection	USA Archery Level 1 or higher instructor	USA Archery Level 1 or higher instructor	1 qualified staff and appropriate assistants	1:3	See also Sporting arrows Shooting Program Guide. Chapter 22, page 149. Council must apply to operate this activity
Cowboy action (BSA accredited Camp programs only)	Scouts BSA (14 or 13 and completed 8th grade), Venturing, Sea Scouting	Eye and hearing protection	NRA certified instructor for each discipline AND NRA RSO	National Camping School shooting Sports Director with current appropriate endorsements Appropriate NRA Instructor for each firearm (separate certifications required for each firearm)	Long-term camp: 1 appropriately NRA certified staff at each station and appropriate assistants Short-term and Day Camp: 1 appropriately NRA certified staff at each station and appropriate assistants AND NRA RSO	1:1	See also Cowboy Action Shooting Program Guide. Chapter 17, page 113. Council must apply to operate this activity



## FIVE LEVELS OF SHOOTING ACTIVITIES

The “Five Levels” have been developed as a planning guide to organize and conduct a safe Scouting shooting activity. Included are the major firearm disciplines: rifle, pistol, shotgun, and muzzleloading. For each discipline, you will find the necessary topics that should be considered as you plan your event.

In general, the five levels are:

1. A first-time shooting experience
2. Open shooting experience
3. Ongoing shooting experience
4. Competitive shooting
5. Becoming an instructor

Whether a Scout unit is going to the camp property or gun club range or participating in a shooting event at a district or council short-term camp, these guidelines are to be followed by those in charge of the gun shooting activity. In all cases BSA guidelines for Youth Protection and supervision must be followed.

- The BSA’s BB gun program is not included in the Five Levels for Rifle Shooting. Refer to Chapter 23 of this manual for information on Cub Scout BB gun shooting.
- BSA long-term camps are not included in the Five Levels for Rifle Shooting.
- The BSA does not allow the use of any fully automatic firearms in its shooting sports program.
- Note that many public and private ranges may have stricter procedures that will take precedence over BSA rules. These stricter rules are the minimum acceptable for BSA shooting sports activities at those ranges.

# 5 LEVELS OF: RIFLE SHOOTING

	Level 1 Air Rifle Shooting Experience	Level 2 Rifle Open Shooting Experience	Level 3 Rifle Ongoing Shooting Sports Program	Level 4 Competitive Level	Level 5 NRA Assistant Rifle Instructor or NRA Assistant Coach
<b>Purpose</b>	Introduce & recruit youth to the BSA and the BSA Shooting Sports Program.	Introduce and recruit Scouts into Shooting Sports programs Ex. Fun Shoot Day or open shoot	Introduce and recruit Scouts into year-round Shooting Sports programs Ex. Shooting Sports MB or Venturing awards	Promote competition among Scouts BSA, Venturers, and Sea Scouts	Scouts BSA, Venturers, and Sea Scouts to take a leadership role in their unit as an NRA Apprentice or Assistant Instructor
<b>Youth</b>	Minimum age 10 years		Scouts BSA, Venturers, Sea Scouts		
<b>Equipment</b>	.177 caliber air rifle, min 2.5 lb trigger pull (open, scope or dot sights); air, CO2, or precharged pneumatic	.177 caliber air rifle, min 2.5 lb trigger pull (open, scope or dot sights); air, CO2, or precharged pneumatic	.177 caliber air rifle, min 2.5 lb trigger pull (open, scope or dot sights); air, CO2, or precharged pneumatic .22 caliber rimfire* (breech-loading, single shot, bolt action or repeater bolt action with box magazine**), trigger pull min 3 lbs Venturers/Sea Scouts may use any cartridge firing rifle (open, scope, or dot sights)	As required by the competition	Rifle meeting minimum requirements for course being taught
<b>Ammunition</b>	.177 caliber pellets		Correct caliber for range and equipment being used Reloading and use of reloaded ammunition is not approved for BSA programs. Tracer, armor-piercing and exploding ammo are not allowed.		
<b>Range</b>	Public/private commercial range or club (must be approved following BSA private property range approval at <a href="https://www.scouting.org/outdoor-programs/shooting-sports/">https://www.scouting.org/outdoor-programs/shooting-sports/</a> ), Portable range (air rifle only), Shooting trailer (air rifle only), Temporary safety enclosure (air rifle only)				
<b>Training for Participants</b>	Five minutes of 3 rules of gun safety, Rifles assigned to shooting station, Rifles are loaded by instructors, Youth point at target and fire	BSA 30-minute rifle briefing	BSA Rifle Shooting Merit Badge OR NRA Basics of Rifle Shooting Course	NRA Basics of Rifle Shooting Course	NRA Rifle Instructor Course
<b>Targets</b>	Bull's-eye targets (large with carrier system), Resetting metallic, Balloons, Other breakable targets no exploding targets)	Paper, Balloons, Resetting metallic, Exploding targets not allowed	Other breakable targets Exploding targets not allowed	As determined by competition Exploding targets not allowed	Mandated by course being taught
<b>Course</b>	Bench rest, prone, or standing position only (bench rest recommended)	Bench rest, Prone, Standing, Kneeling, Sitting	Following requirements of BSA Rifle Shooting Merit Badge or Venturing Ranger Award NRA qualification program	Competition Rule Book (BSA youth protection policies must also be followed.)	NRA Rifle Instructor Course
<b>Safety Equipment</b>	Eye protection		Eye protection (air rifles); Eye and hearing protection		
<b>Instructor</b>	National Camping School Shooting Sports Director holding NRA rifle instructor certification OR an NRA Certified Rifle Instructor			Provided by venue	NRA training counselor
<b>Range Supervision</b>		See chart in Chapter 1		Based on the rules of the approved competition	Based on course being taught
<b>Ratio</b>	1:8 - NRA Range Safety Officer and 1:8 - Instructor (2 separate persons)			Based on the rules of the approved competition	Based on course being taught
<b>Notes</b>	Event may be an air-rifle range set up at a community event, county or state fair, etc.	NRA Marksmanship Qualification Program may be introduced			

\* Tubular not allowed and higher capacity magazines may not be loaded with more than 5 rounds.

\*\* If detachable magazines are used, the range commands must include "magazines out after firing all rounds" to ensure firing line is safe after all shots are fired.



# 5 LEVELS OF SHOTGUN SHOOTING

	Level 1 Shotgun Shooting Experience	Level 2 Shotgun Open Shooting Experience	Level 3 Shotgun Ongoing Shooting Sports Program	Level 4 Competitive Level	Level 5 NRA Assistant Shotgun Instructor
<b>Purpose</b>	There is no Level 1 Shotgun Shooting Experience	Introduce and recruit Scouts into shooting sports programs	Introduce and recruit Scouts into year-round shooting sports programs	Promote competition among Scouts BSA, Venturers, and Sea Scouts	Scouts BSA, Venturers, and Sea Scouts to take a leadership role in their unit as an NRA Apprentice or Assistant Instructor
<b>Youth</b>			Scouts BSA, Venturers, Sea Scouts		
<b>Equipment</b>		Youth and adult-size gas operated semi-automatic shotguns are recommended. Recommended gauges are 20 or 12		As required by the competition	Per the course being taught
<b>Ammunition</b>					Correct ammunition for range and equipment being used Reloading and use of reloaded ammunition is not approved for BSA programs. Tracer, armor-piercing and exploding ammo are not allowed
<b>Range</b>					BSA camp property approved range, Public/private commercial range or club (must be approved following BSA private property range approval at <a href="https://www.scouting.org/outdoor-programs/shooting-sports/">https://www.scouting.org/outdoor-programs/shooting-sports/</a> )
<b>Training for Participants</b>		BSA 30-minute shotgun briefing	Shotgun Merit Badge (Scouts BSA) OR NRA Basics of Shotgun Shooting Course	NRA Basics of Shotgun Shooting Course	NRA shotgun Instructor Course
<b>Targets</b>					clay targets
<b>Course</b>		Single Shell - slow, straight away, and incoming targets.	Following requirements of BSA shotgun Shooting Merit Badge OR Venturing Ranger Award NRA qualification program	Competitive Rule Book for the competition (BSA youth protection policies must also be followed.) Load shells per course of fire (Ex. skeet, where 2 shot shells are loaded)	Following requirements of the NRA shotgun Instructor Course
<b>Safety Equipment</b>					
<b>Instructor</b>		National Camping School Shooting Sports Director holding NRA shotgun instructor certification OR an NRA certified shotgun instructor.		National Camping School Shooting Sports Director holding NRA shotgun instructor certification OR NRA certified shotgun coach OR specific competition supervision required	NRA training counselor
<b>Range Supervision</b>		See chart in Chapter 1		Based on the rules of the competition	Based on course being taught
<b>Ratio</b>		1:6 - NRA Range Safety Officer and 1:1 - Instructor (2 separate persons)		Based on the rules of the competition	Based on course being taught
<b>Notes</b>		This event can be a shooting day at the range shoot, NRA Day event or NRA Marksmanship Qualification Program may be introduced. A BSA short-term camp could also be appropriate.			

# 5 LEVELS OF PISTOL SHOOTING

	Level 1 Air Pistol Shooting Experience	Level 2 Pistol Open Shooting Experience	Level 3 Pistol Ongoing Shooting Sports Program	Level 4 Competitive Level	Level 5 NRA Assistant Pistol Instructor or NRA Assistant Coach
<b>Purpose</b>	Introduce & recruit youth to the BSA and the BSA Shooting Sports Program.	Introduce and recruit Venturers and Sea Scouts into shooting sports programs	Introduce and recruit Venturers and Sea Scouts into year-round shooting sports programs	Promote competition among Venturers and Sea Scouts	Venturers, and Sea Scouts to take a leadership role in their unit as an NRA Apprentice or Assistant Instructor
<b>Youth</b>	Min Age 14 yrs or 13 years and completed the 8th grade		Venturers, Sea Scouts		
<b>Equipment</b>	.177 caliber air pistol, min 2.5 lb trigger pull (open, scope or dot sights); air, CO2, or pre-charged pneumatic	.177 caliber air Pistol, min 2.5 lb trigger pull (open, scope or dot sights); air, CO2, or pre-charged pneumatic cartridge firing pistol with trigger pull min. 3 lbs; open, scope or dot sights		As required by the competition	Pistol meeting minimum requirements for course being taught
<b>Ammunition</b>	.177 caliber pellets				
<b>Range</b>		Reloading and use of reloaded ammunition is not approved for BSA programs. Tracer, armor-piercing and exploding ammo are not allowed			
<b>Training for Participants</b>		Public/private commercial range or club (must be approved following BSA camp property approved range, BSA private property range approval at <a href="https://www.scouting.org/outdoor-programs/shooting-sports/">https://www.scouting.org/outdoor-programs/shooting-sports/</a> ), Portable range (air Pistol only) Shooting trailer (air Pistol only) Temporary safety enclosure (air Pistol only)			
<b>Targets</b>	Bull's-eye targets (large with carrier system), Resetting metallic, Balloons, Other breakable targets (NO exploding targets)	BSA 30-minute pistol briefing 1:1 Ratio Instructor loads pistol	NRA Basics of Pistol Shooting Course (8 hrs)		NRA Pistol Instructor Course
<b>Course</b>	Bench rest position only	Bench rest or two-handed standing	Following requirements of the Venturing Ranger Award	As required by the rule book of the competition	Mandated by course being taught
<b>Safety Equipment</b>	Eye protection		Competitive Rule Book for the competition (BSA youth protection policies must also be followed.)		NRA Pistol Instructor Course
<b>Instructor</b>		NRA certified Pistol instructor	Eye protection (air pistols) Eye and hearing protection	Based on the competition	NRA training Counselor
<b>Range Supervision</b>		Certified NRA Range Safety Officer AND NRA certified Pistol instructor Must be 2 separate individuals		Based on the rules of the approved competition	Based on course being taught
<b>Ratio</b>		1:3 - NRA Range Safety Officer and 1:1 - Instructor (2 separate persons)		Based on the rules of competition	Based on course being taught
<b>Notes</b>	Event may be an air pistol range set up at a community event, county or state fair, etc.	NRA Marksmanship Qualification Program may be introduced			

# 5 LEVELS OF: MUZZLELOADING RIFLE SHOOTING

	Level 1 Muzzleloading Rifle Experience	Level 2 Muzzleloading Rifle Open Shooting Experience	Level 3 Muzzleloading Rifle Ongoing Shooting Sports Program	Level 4 Competitive Level	Level 5 NRA Co-Op Muzzleloading Rifle Instructor
<b>Purpose</b>	There is no Level 1 Muzzleloading Rifle Experience	Introduce and recruit Scouts into shooting sports programs	Introduce and recruit Scouts into year-round shooting sports programs	Promote competition among Scouts BSA, Venturers, and Sea Scouts	Scouts BSA, Venturers, and Sea Scouts to take a leadership role in their unit as an NMLRA Instructor, NRA Co-Op Muzzleloading Rifle Instructor, or NRA Range Safety Officer.
<b>Youth</b>			Scouts BSA Venturers Sea Scouts		
<b>Equipment</b>		Muzzleloading rifles in appropriate size for participant Matchlock, wheellock or flintlock firearms are not approved.		Equipment will meet the requirements for the conventional and international muzzleloading rifle competitive programs Matchlock, wheellock or flintlock firearms are not approved.	Muzzleloading rifle meeting minimum requirements for course being taught Matchlock, wheellock or flintlock firearms are not approved.
<b>Ammunition</b>			Correct ammunition for equipment being used Commercially manufactured projectile and components are the only types approved Blackpowder substitutes are the only approved propellant		
<b>Range</b>			Public/private commercial range or club (must be approved following BSA private property range approval at <a href="https://www.scouting.org/outdoor-programs/shooting-sports/">https://www.scouting.org/outdoor-programs/shooting-sports/</a> )		
<b>Training for Participants</b>		BSA 30-minute muzzleloading rifle briefing	Basic instruction on loading and firing, range rules and safety for muzzleloading rifle	Basic muzzleloading rifle instruction including cleaning and maintenance	NRA Co-Op Muzzleloading Rifle Instructor course, NMLRA Instructor course, NRA Range Safety Officer course
<b>Targets</b>		Paper, Balloons. Resetting metallic, Other breakable targets Exploding targets not allowed	Paper, Balloons. Resetting metallic, Other breakable targets Exploding targets not allowed	Based on the rules of the competition	Based on the course being taught
<b>Course</b>		Bench rest, cross sticks, or standing Instructor follows the three-step method (EDGE)	Following requirements of the BSA Rifle Shooting Merit Badge or Venturing Ranger Award	Competitive Rule Book for the competition (BSA youth protection policies must also be followed.)	NMLRA Instructor course, NRA/NMLRA Co-Op Muzzleloading Rifle Instructor course, NRA Range Safety Officer course
<b>Safety Equipment</b>			Eye and hearing protection		
<b>Instructor</b>		National Camping School Shooting Sports Director with current NRA Co-Op Muzzleloading Rifle Instructor Certificate OR an NRA/NMLRA certified muzzleloading instructor.		based on the competition	NRA Training counselor
<b>Range Supervision</b>		NRA certification as an NRA Co-Op Muzzleloading rifle instructor OR an NRA- NMLRA instructor		Based on the rules of the competition	Based on course being taught
<b>Ratio</b>		1:8 - NRA Range Safety Officer and 1:1 - Instructor (2 separate persons)		Based on the rules of the competition	Based on course being taught
<b>Notes</b>		This event can be a shooting day at the range, NRA Day event or NRA Marksmanship Qualification Program may be introduced. A BSA short-term camp could also be appropriate.			

# 5 LEVELS OF MUZZLELOADING SHOTGUN SHOOTING

	Level 1 Muzzleloading Shotgun Experience	Level 2 Muzzleloading Shotgun Open Shooting Experience	Level 3 Muzzleloading Shotgun Ongoing Shooting Sports Program	Level 4 Competitive Level	Level 5 NRA/NMLRA Muzzleloading Shotgun Instructor
<b>Purpose</b>	There is no Level 1 Muzzleloading Shotgun Experience	Introduce and recruit Scouts into shooting sports programs	Introduce and recruit Scouts into year-round shooting sports programs	Promote competition among Scouts BSA, Venturers, and Sea Scouts	Scouts BSA, Venturers, and Sea Scouts to take a leadership role in their unit as an NRA/NMLRA muzzleloading Instructor
<b>Youth</b>			Scouts BSA Venturers Sea Scouts		
<b>Equipment</b>		10 gauge or smaller muzzleloading shotgun			Muzzleloading shotgun meeting minimum requirements for course being taught
<b>Ammunition</b>			Correct ammunition for equipment being used Commercially manufactured projectile and components are the only types approved Shot size should be 7 1/2 or smaller		
<b>Range</b>			BSA camp property approved range Public/private commercial range or club (must be approved following BSA private property range approval at <a href="https://www.scouting.org/outdoor-programs/shooting-sports/">https://www.scouting.org/outdoor-programs/shooting-sports/</a> )		
<b>Training for Participants</b>		BSA 30-minute muzzleloading shotgun briefing	Basic instruction on loading and firing, range rules and safety for a muzzleloading shotgun	Basic Muzzleloading Shotgun instruction including cleaning and maintenance	NRA/NMLRA muzzleloading Instructor course
<b>Targets</b>		Clay Targets	Clay Targets	Clay targets and other targets approved for the competition	Clay targets and other targets approved for the competition
<b>Course</b>		Slow, straightaway targets	Following requirements of the BSA Shotgun Shooting Merit Badge Venturing Ranger Award NRA Marksmanship Qualification Regulation skeet, trap targets shot at 10, 16, or 20 yards	Competitive Rule Book for the competition (BSA youth protection policies must also be followed.)	Based on the requirements of the NRA/NMLRA Muzzleloading Shotgun Instructor course
<b>Safety Equipment</b>			Eye and hearing protection		
<b>Instructor</b>			NRA/NMLRA certified muzzleloading instructor.	Based on competition	NRA Training counselor
<b>Range Supervision</b>			Certified NRA Range Safety Officer AND NRA/NMLRA certified muzzleloading instructor.	Based on the rules of the competition	Based on course being taught
<b>Ratio</b>			1:6 - NRA Range Safety Officer and 1:1 - Instructor (2 separate persons) May have one adult to run hand trap if applicable	Based on the rules of the competition	Based on course being taught
<b>Notes</b>			This event can be a shooting day at the range, NRA Day event or NRA Marksmanship Qualification Program may be introduced. A BSA short-term camp could also be appropriate.		

# 5 LEVELS OF MUZZLELOADING PISTOL SHOOTING

	Level 1 Muzzleloading Pistol Experience	Level 2 Muzzleloading Pistol Open Shooting Experience	Level 3 Muzzleloading Pistol Ongoing Shooting Sports Program	Level 4 Competitive Level	Level 5 NRA/NMLRA Muzzleloading Pistol Instructor
<b>Purpose</b>	There is no Level 1 Muzzleloading Pistol Experience	Introduce and recruit Scouts into shooting sports programs	Introduce and recruit Scouts into year-round shooting sports programs	Promote competition among Venturers and Sea Scouts	Venturers and Sea Scouts to take a leadership role in their unit as an NMLRA muzzleloading pistol instructor
<b>Youth</b>			Venturers, Sea Scouts		
<b>Equipment</b>		Percussion, single-barrel or revolver muzzleloading pistol in appropriate size for the participant Matchlock, wheellock or flintlock firearms are not approved.		Meets requirements for the conventional and international muzzleloading pistol shooting competitive programs Matchlock, wheellock or flintlock firearms are not approved.	Muzzleloading pistol meeting minimum requirements for course being taught
<b>Ammunition</b>			Correct ammunition for equipment being used Commercially manufactured projectile and components are the only types approved Blackpowder substitutes are the only approved propellant		
<b>Range</b>			Public/private commercial range or club (must be approved following BSA private property range approval at <a href="https://www.scouting.org/outdoor-programs/shooting-sports/">https://www.scouting.org/outdoor-programs/shooting-sports/</a> )		
<b>Training for Participants</b>		BSA 30-minute muzzleloading pistol briefing	Basic instruction on loading and firing, range rules and safety for a muzzleloading pistol	Basic muzzleloading pistol instruction including cleaning and maintenance	NRA/NMLRA muzzleloading instructor course
<b>Targets</b>		Paper, Resetting metallic, Balloons, Other breakable targets (No exploding targets)		As required by the rule book for the competition (No exploding targets)	Mandated by course being taught (No exploding targets)
<b>Course</b>		Bench rest or Two-handed standing	Following requirements of the Venturing Ranger Award OR NRA Marksmanship Qualification	Competitive Rule Book for the competition BSA youth protections policies must also be followed.	NRA/NMLRA Muzzleloading Pistol Instructor course
<b>Safety Equipment</b>			Eye and hearing protection		
<b>Instructor</b>			NRA/NMLRA certified muzzleloading instructor.	based on competition	NRA training counselor
<b>Range Supervision</b>			Certified NRA Range Safety Officer AND NRA/NMLRA certified muzzleloading instructor.	Based on the rules of the competition	Based on course being taught
<b>Ratio</b>			1:3 - NRA Range Safety Officer and 1:1 - Instructor (2 separate persons)	based on the competition	Based on course being taught
<b>Notes</b>			This event can be a shooting day at the range. NRA Day event or NRA Marksmanship Qualification Program may be introduced. A BSA short-term camp could also be appropriate.		



## CHAPTER 2: BSA SHOOTING SPORTS—A WEALTH OF YEAR-ROUND OPPORTUNITIES

### CUB SCOUT PROGRAMS

Cub Scout shooting sports programs may be conducted only on a district or council level. Archery, slingshot and BB gun shooting are restricted to day camps, Cub Scout/Webelos Scout long-term camps, council-managed short-term camps, or to council activities where there are properly trained supervisors and all standards for BSA shooting sports are enforced. Archery, slingshot and BB gun shooting are prohibited at the pack level.

The use of pellet air rifles is restricted to Webelos Scouts in a long-term camp setting only.

### SCOUTS BSA PROGRAMS

Scouts BSA shooting sports can take place at any council-approved property. This could include a BSA-approved range or a public or private commercial range or club. Information for approval of public or private ranges can be found at <https://www.scouting.org/outdoor-programs/shooting-sports/>

The council's camp may be an ideal location for shooting sports. Here, safely designed ranges may be established for the long-term camping program. Under qualified leadership, Scouts, should be given a chance to participate in these skills year-round. Alert unit, district, and council leadership will discover community resources that will be available to units throughout the year. Local archery, National Rifle Association, and sportsmen's groups will often provide facilities and resources.

Scouts BSA members can shoot small-bore rifle, shotgun, muzzleloading rifle, muzzleloading shotguns, and archery following the five levels of shooting described in the chart in Chapter 1.

For information about the Scouts BSA Merit badge programs refer to the following publications:

- Rifle Shooting merit badge pamphlet, No. 35942
- Shotgun Shooting merit badge pamphlet, No. 35948.
- Archery merit badge pamphlet, No. 35856.

**Long-term and Short-term camp programs.** The BSA camp program offers a wide variety of shooting sport opportunities for Scouts. Each local council will serve as a resource for more information on what that council's camp offers.

**Hunter education** (Scouts BSA/Venturing and Sea Scouting). Contact your local department of natural resources for more information on hunter safety and education, or find information online at [www.hunter-ed.com](http://www.hunter-ed.com) (Hunting programs are only approved for Venturing and Sea Scouting).

### VENTURING AND SEA SCOUT PROGRAMS

Venturers and Sea Scouts are approved to shoot the same firearms as Scouts BSA and may also shoot rifles, pistols, and revolvers of any caliber or action. An exception is they may not shoot fully automatic firearms. Refer to “Five Levels of Shooting Activities” in Chapter 1 to better understand what qualifications must be met for Venturing and Sea Scouting.

### Opportunities

In addition to the opportunities offered for Scouts BSA listed above, Venturers and Sea Scouts also have an opportunity to participate in the hunting experience. The Ranger Award is an excellent way to learn more about hunting education and safety.

**BSA Shooting Sports Outstanding Achievement Award.** While working on the Ranger Shooting Sports elective, Venturers and Sea Scouts are to complete one of the following disciplines: air pistol, air rifle, archery, muzzleloading rifle, shotgun, pistol, or small-bore rifle. However, Venturers and Sea Scouts who go beyond the basic requirement and complete five of the seven disciplines will earn the Venturing Shooting Sports Outstanding Achievement Award. This medal and certificate are sponsored by many companies and organizations in the shooting sports industry to recognize outstanding achievement in shooting sports.

For more information, go to <https://www.scouting.org/awards/awards-central/venturing-shooting/>

### Training Programs for Adults and Youth

See Section IV on training in this book.

### Council Shooting Sports Committees

Your local council's shooting sports committee provides an opportunity to become involved in the shooting sports program on a year-round basis. Refer to Chapter 4 for more information on council shooting sports committees.

***NRA National Youth Shooting Sports  
Ambassadors***

The program offers participants a wide array of benefits, ranging from cash awards and travel opportunities to meeting national shooting celebrities. For more information on the NRA National Youth Shooting Sports Ambassador Program, visit [youthambassadors.nra.org](http://youthambassadors.nra.org)



## CHAPTER 3: MERIT BADGE COUNSELORS

### Shooting Sports Merit Badge Counselor Requirements and Registration

To qualify as a shooting sports merit badge counselor, a volunteer must:

- Register annually with the Boy Scouts of America as a Merit Badge Counselor.  
Rifle Shooting and Shotgun Shooting—The merit badge counselor must take responsibility to assure that all instruction involving the handling of firearms or live ammunition must be supervised by a certified individual as outlined in this guide or the Merit Badge pamphlet.  
In approving merit badge counselors, the local council advancement committee has the authority to establish a minimum, reasonable level of skills and education for the counselor of a given merit badge.
- For additional information about Merit Badge counselors see the latest edition of the Guide to Advancement <https://filestore.scouting.org/filestore/pdf/33088.pdf>

- Merit badge pamphlet series. The merit badge pamphlets are written for Scout-age youth. The information presented in the pamphlet will help the counselor understand what the Scout may be studying and the level of learning expected by the Boy Scouts of America. The pamphlets may also contain suggestions for projects or demonstrations required to earn the merit badge. Once a Scout has started working on a merit badge, they may continue with the requirements in effect when the badge was started. The Scout is not required to meet newly introduced changes unless the national office places a specific timeline on the implementation of new requirements.

Shooting sports merit badge pamphlets include:

- *Rifle Shooting*, No. 35942
- *Shotgun Shooting*, No. 35948
- *Archery*, No. 35856

### Resources for Merit Badge Counselors

- BSA Shotgun Shooting Merit Badge Teaching Guide. Refer to Appendix 1.
- BSA Rifle Shooting Merit Badge Teaching Guide. Refer to Appendix 2.
- *Guide to Advancement*, No. 33088.
- Application for Merit Badge (blue card), No. 34124. This three-panel, blue, wallet-size card shows that the Scout has permission from their Scoutmaster to start working on a particular merit badge, records their progress, and when completed, provides a separate record for the Scout, the counselor, and the unit.
- *Scouts BSA Handbook for Boys*
- *Scouts BSA Handbook for Girls*
- A Guide for Merit Badge Counseling, No. 34532. This folder gives potential merit badge counselors an introduction to the advancement program and the merit badge counselor's role. It also lists all the current merit badge subjects.
- Merit Badge Counselor Information form, No. 34405. When attached to the Adult Application, this document specifies the merit badge subjects a counselor wants to coach and secures the counselor's agreement to follow the merit badge requirements and BSA policies. This form is available online at [www.scouting.org/filestore/pdf/34405.pdf](http://www.scouting.org/filestore/pdf/34405.pdf).





## SECTION II BEYOND THE UNIT LEVEL

In addition to Section I, the information contained in Section II through Section VI is necessary for individuals who are involved in the shooting sports programs outside the unit level. This includes NRA Instructors, NRA Range Safety Officers, National Camping School shooting sports directors, council shooting sports chairs, council shooting sports committee members, council professionals, camping committees, camp rangers, and all others who are involved in organizing and assisting in the delivery of the various shooting events throughout the year.



## CHAPTER 4: COUNCIL SHOOTING SPORTS COMMITTEES

### Organization

It is strongly recommended that all local councils have a shooting sports committee. The purpose of the committee is to manage and provide resources to the council, the camping committee, and the council camps for all activities involving shooting sports whether during summer camps or during year-round shooting opportunities. All shooting sports activities should be coordinated through the shooting sports committee to verify that a safe and responsible program is planned and conducted by properly trained and currently certified personnel.

### Responsibilities

#### ***Council Shooting Sports Committee Chairman/Coordinator***

The organization should be composed of a shooting sports chairperson/coordinator with a working understanding of BSA Short-term and Long-term camp programs, and the knowledge, skills, and attitude to organize and ensure safe range operation for each shooting sports program. The chairperson is appointed by the council president or their designee. The committee shall report to the council vice president for program, the camping committee chair, the health and safety chair, or the council risk management committee chair as appropriate for the individual council organization.

- An age of 21 years or older and National Camping School certification as a shooting sports director is recommended.
- National Rifle Association certified instructor for one or more of the appropriate disciplines is recommended.
- Current NRA Range Safety Officer rating is recommended.
- Current USA Archery Level 1 instructor certification is recommended.
- Schedules meetings, preferably on a monthly basis, of the shooting sports committee and assigns individual committee member responsibilities. Keeps the council Scout Executive or a designee informed of committee actions.
- Advises the summer camp National Camping School shooting sports director in ensuring all shooting sports requirements in the national standards are being met.
- Accompanies the area camp assessment team on the tour of the shooting sports facilities and answers any questions it has relating to compliance with the national standards.

- If requested by the Scout executive, their representative or the camp director submits an evaluation on the National Camping School shooting sports director and staff and makes a recommendation on their employment in the future.
- Ensures adequate training sessions are conducted annually to certify BB gun and archery Rangemasters for Cub Scout day camp, short term camp or other council or district activities.
- Assists the camp director in identifying and recruiting the shooting sports director for summer camp in the event of illness or emergency. Serves in this capacity as requested or appointed by the camp director.
- Ensures compliance with all BSA/NRA shooting sports standards for Cub Scout, Scouts BSA, Venturing, and Sea Scout programs on and off council property.
- Maintains a current inventory of all council shooting sports equipment and supplies and provides copies to all interested persons.
- Compiles on a timely basis a list of equipment and supplies needed for summer camp and year-round operation and submits it to the council executive or their designee for procurement.
- Assists in developing and continuing review of range safety standard operating procedures.
- Schedules range maintenance to ensure all shooting sports facilities and equipment meet BSA/NRA standards prior to all uses.
- Identifies adult Scouters to help in year-round shooting sports programs and ensures they hold the appropriate current NRA certification.
- Maintains a current list of individuals with NRA and USA Archery certifications and National Camping School training.
- Recommends fee structures for year-round use of shooting sports facilities and equipment.
- Serves as a resource for shooting sports merit badges, unit shooting sports activities, or other council or district shooting sports events.
- Makes recommendations to the Scout executive or their designee on procurement of BB Guns, firearms, archery equipment, and supplies.
- Working with the council executive, apply to the available grant programs in order to fulfill current and future shooting sport needs. Grant programs are available through USA Archery, the National Rifle Association, Friends of the NRA local banquets, and local gun and sportsman clubs.
- Any other responsibilities as determined in cooperation with the council Scout executive and the council president or their designees.

### ***Committee Members***

- Assist the council shooting sports committee chairman in performing the duties of the shooting sports committee.
- Committee members are nominated by the chairman and/ or other committee members, and are approved by the council president or their designee.
- NRA certified instructor in at least one of the NRA disciplines is recommended.
- NRA Range Safety Officer certification is recommended.
- Shooting sports committee members may be appointed to the council committee at large.

## CHAPTER 5: RANGE OPERATION

In planning any shooting sports activity, consideration must be given to what equipment is required for that specific shooting discipline and venue. Care must be taken to provide, or arrange for, the safety of non-participants as well as personal protection of the participant. This chapter examines some of the items that should be considered.

### General Equipment Common to All Scouting Program Levels and Shooting Disciplines

**Range safety flag.** As an indicator that the range is active, the range safety flag is to be displayed on a flagpole in a prominent place visible to approaching spectators and participants. Each range should have its own flagpole. It is recommended the flag be made of a bright red material approximately 48-by-36 inches in size. (This flag can be purchased from the NRA's online store.) The flag should be removed at the end of the shooting session.

**Eye and hearing protection.** Each participant must wear hearing and eye protection appropriate for the shooting discipline. Spectators in the immediate, designated area must also wear protection as appropriate. ANSI Z87.1 is the approved rating and the industry standard. Shooting sports safety glasses with this rating should be worn anytime safety glasses are prescribed.

This personal safety equipment may be provided by the shooting event or furnished by the individual participant. If provided by the individual, the Range Safety Officer or NRA instructor should verify that eyeglasses have adequate lens area to offer protection. Hearing protection must fit properly

If eye and hearing protection is furnished by the event organizers, an assortment of sizes should be on hand to ensure proper fit. Youth sizes are available from many vendors of safety glasses. Earmuffs might be preferable to earplugs. When exchanging common-use items, be sure to clean and disinfect them before wearing them. Earplugs are NOT to be exchanged.

**Empty-chamber indicator.** An added safety measure while transporting or storing, or while the firearm is, UNLOADED AND NOT BEING USED ON THE FIRING LINE a visual empty-chamber indicator should be installed. Several commercial models are available which when installed in the chamber displays a brightly colored flag readily visible.

A simple alternate method is to use a piece of high-visibility, heavy monofilament trimmer line, cut approximately 12 inches longer than the barrel of the firearm. When inserted through the barrel, approximately 6 inches of line is visible at both the muzzle and the breech.

**Ammunition control.** A simple ammunition block, with an appropriate number of 15/64-inch-diameter holes drilled in a pattern of a multiple of five, should be used to control the ammunition being dispensed to the participants. Range personnel will load the blocks from the bulk ammunition storage, and issue only the number of rounds being fired for a given relay. If magazines are being used, range personnel will load magazine prior to distribution.

### Comfort items.

- Sling. A leather or web sling will aid participants in the prone, kneeling, and sitting positions. They are easily adjustable to each participant and will steady the participant.
- Prone mat. A padded shooting mat of approximately 30-by-60 inches should be provided at each prone shooting position.
- Kneeling roll. A piece of carpet remnant approximately 8 inches wide and tightly rolled and bound to approximately 4 to 6 inches in diameter may be placed under the ankle of the down leg when shooting in the kneeling position.

**First-aid kit.** A first-aid kit must be readily accessible to the range or classroom. It should be well stocked and include items appropriate for potential injuries unique to the specific shooting sports venue. A medical log must be included in each kit. Details of each incident should be recorded. Any injury requiring first aid of any kind must be recorded in the First Aid Log for camp if the activity is a part of a Council long term, short term or day camp. Expended materials should be replaced before the next activity. Contents should be monitored and replaced as needed.

**Emergency communications device.** The procedure to summon emergency help must be considered during planning and be verified before the start of the event. The details of the exact location should also be noted in the event of an emergency. All range personnel should be familiar with the emergency procedures of the event and understand how to reach help.

## Range and Shooting Equipment Appropriate to Each Scouting Program Level

**NOTE: The Cub Scout Shooting Sports programs are authorized for District and Council events only and are not approved for use at the unit level. For approved shooting activities for each age level, refer to the age appropriate guidelines of the BSA. <https://filestore.scouting.org/filestore/HealthSafety/pdf/680-685.pdf>**

### **BB Gun**

**BB Gun.** Only a smoothbore, spring-type air gun propelling a coated steel ball projectile commonly known as a “BB” may be used.

**Target.** The target line is usually 16.5 feet from the firing line. The TQ-40 and AR-4 are the common targets for this distance. Paper plates or aluminum pie tins are also popular targets for Cub Scouts and training new shooters. Animal, zombie, and human form silhouettes are not approved for Cub Scout use. Appropriate animal silhouettes including wild game species normally hunted are appropriate for Scouts BSA, Venturers, or Sea Scout use. Zombie and human form silhouettes are not approved for use in any BSA shooting sports programs.

**Personal Protection.** All participants must wear eye protection.

### **Air Rifle**

**Air Rifle.** Spring, piston or pneumatic (single stroke, multi-pump, air, or CO2 gas) air rifles with rifled barrels bored for .177-caliber skirted pellets may be used. Air Rifles may be used by Webelos Scouts, Scouts BSA, Venturers and Sea Scouts. Webelos use is restricted to long-term camps only.

- The air rifle pellet gun range meets or exceeds BSA and NRA recommendations and appropriate BSA Outdoor Programs/Properties design standards.
- All rifles in good repair are provided. All air rifles used in BSA shooting sports have a trigger pull in excess of 2.5 pounds and are tested with a 2.5-pound weight or scale at least once a week while in use. If any trigger mechanism fails, the air rifle is immediately removed from service. Documentation of the tests is maintained.
- **Webelos Only:** All air rifles (CO2, pump, break barrel, etc.) are limited to single-shot designated for target shooting, velocity of 500 to 540 feet per second, and energy levels not to exceed 7.5 joules.
- Air rifle propellant is limited to CO2 cylinders or air compressor/scuba tanks. Refilling is conducted by qualified/trained adults with appropriate controls. If scuba tanks are used, each tank must be visually inspected annually and hydrostatically tested every five years by a qualified technician. Scuba tanks used for shooting sports purposes may not be used for scuba purposes.

**Air Rifle Target.** The target line is usually set at 33 feet from the firing line. The TQ-18 and AR-5 are the common targets for this distance. Paper plates or aluminum pie tins are also popular targets for training new shooters. Animal, zombie, and human form silhouettes are not approved for Webelos Scout use. Appropriate animal silhouettes including wild game species normally hunted are appropriate for Scouts BSA, Venturers, or Sea Scout use. Zombie and human form silhouettes are not approved use in any BSA shooting sports programs.

**Personal Protection.** All participants must wear eye protection.

### **Rifle**

#### **Rifle.**

**Scouts BSA** May only use .22 caliber breech-loading, single-shot or a repeater type bolt-action rifles with a box-style magazine. (Only .22 caliber Short, long, long rifle may be used.) (Tubular magazines are not allowed for Scouts BSA members.) \*Note: Tubular magazines may be used in approved Cowboy action programs only following the guidelines in the Cowboy action brochure No. 510-318. Councils must be approved by the National Council to offer Cowboy action programs using the application found at <https://www.scouting.org/outdoor-programs/shooting-sports/>

**Venturers and Sea Scouts.** May shoot rifles of any caliber or action **except fully automatic.**

**Ammunition.** Current-manufacture cartridges appropriate for the caliber firearm being used. **Reloading and use of reloaded ammunition is not approved for BSA programs. Tracer, armor-piercing and exploding ammo are not allowed.**

#### **Sights.**

- Open sights found on most rifles are limited to elevation adjustment.
- Aperture (peep) sights are fully adjustable and have an easy-to-learn sight picture. The easy adjustment will aid in qualification shooting.
- Optical (red dot, telescopic) sights are also fully adjustable.

**Targets.** TQ-1, TQ-5, and A-17 targets are recommended at 50 feet. The A-23 is a popular small-bore rifle target at 50 yards and the A-25 is sized for 100 yards. Scouts BSA, Venturers, and Sea Scouts are allowed to use tasteful and appropriate animal silhouette targets (paper and 3-D targets) with all firearms approved for their use. Appropriate animal silhouettes include wild game species that are normally hunted. Human form and zombie silhouette targets are not approved for use. Metallic silhouette animal targets are also approved for use.

Exploding targets are NOT approved for ANY shooting activity.



**Personal Protection.** All participants must wear eye and hearing protection.

### **Shotgun**

**Shotgun.** Modern sporting shotguns of any gauge may be used. However, experience shows that beginning shotgun participants will be more successful with a 20- or 12-gauge shotgun, putting more shot to the target. The semi-automatic shotgun will produce less felt recoil, thus making the shooter more comfortable.

**Chokes.** At the muzzle end of the shotgun is a “choke.” Just as the nozzle of a garden hose determines the width of a jet of water, the choke affects the spread pattern of the pellets exiting from the barrel. There are four main chokes: skeet, IC (improved cylinder), M (modified), and F (full). For camp use, skeet and IC are recommended. If these are not available, modified would be the best choice.

**Ammunition.** Current-manufacture shotshells of the appropriate gauge contain No. 7½ to No. 9 shot. A shot size larger than 7½ is not to be used. **Reloads may not be used in BSA shooting sports programs.**

**Trap/thrower.** Hand throwers, manual traps, or automatic traps may be used. Care should be taken to match the target speed and flight path to the shooter’s ability. Always refer to the manufacturer’s operations and safety instructions before operating this equipment.

**Trap location.** For new shooters and merit badge qualification, the trap should present a straight-away, rising target, at a reasonable speed. Trap systems on trap and skeet fields and on sporting clays courses will provide the participant with some challenging presentations as skills are mastered.

**Personal Protection.** All participants must wear eye and hearing protection.

### **Muzzleloading Firearms**

Because of the historical significance of muzzleloading firearms, Scouts BSA members, Venturers, and Sea Scouts are encouraged to learn to safely load and shoot a muzzleloader. On the range, each participant must be under the direct supervision (one-on-one) of a currently certified NRA or NRA/NMLRA muzzleloading instructor (for the appropriate discipline) when loading or firing the muzzleloader.

**Scouts BSA. May only use muzzleloading rifles or muzzleloading shotguns. (No muzzleloading handguns are permitted in the Scouts BSA program.)**

**Venturers and Sea Scouts.** May shoot muzzleloading rifles, muzzleloading shotguns or muzzleloading pistols.

**Muzzleloading rifles and pistols.** Recently manufactured (or assembled from a kit) percussion cap muzzleloading rifles or pistols or inline muzzleloading rifles or pistols of any caliber may be used. All muzzle-

loading rifles and pistols are subject to safety inspection by the instructor or range officer. Rifles and pistols made from kits must be checked by a qualified gunsmith.

**Propellant.** Only a commercially manufactured, sporting-grade black powder or black powder substitute offered for sale by a reputable firm should be used in muzzleloading firearms. For new shooters, the amount of propellant in grains should be at the minimum of the gun manufacturer’s recommended load range.

### **Accessories.**

- **Ramrod.** The ramrod is used to seat the patch and shot. It is usually mounted in the fore-end of the stock, just beneath the barrel. It is recommended that a more durable work rod be obtained for use on the range. The first time a new rod is used, it should be inserted into the empty barrel all the way down. A permanent mark should be scribed on the rod at the end of the muzzle. Then the same procedure should be used after a standard charge (powder, patch, and ball) has been placed in the barrel. This will enable the shooter to know whether the barrel is empty or has a standard charge.
- **Powder flask and powder measure.** Propellant shall be transferred from the original bulk container to a brass or plastic powder flask to be taken to the range. It shall then be poured into the powder measure before pouring into the barrel.
- **Shot starter.** (ml rifle or ml pistol) This tool allows the shooter to first get the ball and patch just started into the muzzle, and second to drive the ball a short distance down the barrel, before using the ramrod to seat the patch and ball against the powder charge.
- **Shot measure.** (ml shotgun) A small cup with a handle that allows the shooter to measure the exact amount of shot and then pour it directly into the barrel.
- **Nipple wrench and nipple pick.** The nipple wrench is simple tool used to remove the cap nipple should it become fouled. A nipple pick is a stiff wire that is used to clear debris in the nipple orifice (flash channel).
- **Capper.** Percussion caps are packaged 100 per tin. The capper allows the caps to be dispensed one at a time right onto the nipple.
- **Patch puller, ball puller.** These tools fit onto the end of the ramrod to remove the ball or patch from down in the barrel. Care must be taken when using these items.
- **CO<sub>2</sub> ball discharger.** This tool has a fitting to fit onto the nipple and has a small CO<sub>2</sub> cartridge to provide pressure to blow a patch and ball out of the muzzle of the gun. **Always point the muzzle-loader in a safe direction when using this device.**
- **Loading bench.** Many Scout ranges are equipped with a loading bench that provides a stable and easy-to-reach platform for the muzzleloading firearm during the loading process.

**Personal Protection.** All participants must wear eye and hearing protection.

### **Pistols**

**Pistols are approved for use at the Venturing and Sea Scouting level ONLY. No handguns are permitted in the Scouts BSA programs except for those approved by the BSA National Council to participate in the BSA Pistol Marksmanship Program or as a part of the Cowboy Action Shooting program.**

**Handguns of any type are NOT permitted for Cub Scouting.**

**Semiautomatic pistols and revolvers.** Venturers and Sea Scouts may shoot handguns of any caliber or action except fully automatic.

**Sights.** Open sights may be fixed or adjustable. Optical sights (red dot and telescopic) sights are also fully adjustable, but care must be taken to provide an appropriate scope for the shooting distance. Laser sights have become extremely popular as a training aid for pistol shooting; however, they may not be permitted for certain qualification programs.

**Targets.** A 9-inch paper plate is recommended for training new shooters at 15 feet. The TQ-6, slow-fire, and TQ-7 rapid-fire targets are recommended at 25 feet. B-2, slow-fire, and B-3, timed and rapid-fire are popular pistol targets at 50 feet. The B-16, slow-fire, and B-8, timed and rapid-fire, targets are sized for 25 yards. Appropriate animal silhouettes include wild game species that are normally hunted. Human form and zombie silhouette targets are not approved for use. Metallic silhouette is becoming a popular target discipline at many clubs and ranges. **NO exploding targets are allowed in any BSA program.**

**Personal Protection.** All participants must wear eye and hearing protection.

**Pointing any type of firearm or simulated firearm at any individual is unauthorized. Units with council approval may participate in formally organized historical reenactment events where firearms are used and intentionally aimed over the heads of reenactment participants. Leaders and the council approvers for participation must complete the SAFE Checklist during planning for attendance or participation.**

### **Archery**

#### **Bows.**

**Cub Scouts.** A light-draw-weight (15- to 20-pound), 54-inch, take-down, recurve bow is recommended because the bow will fit many archers who have different lengths of draw.

**Scouts BSA.** A light-draw-weight (20- to 25-pound), 62-inch or 66-inch, take-down, recurve bow is recommended because the bow will fit many archers who may have different lengths of draw.

**Venturers and Sea Scouts.** A light-draw-weight (20- to 35-pound), 62-, 66-, or 70-inch, take-down, recurve bow is recommended because the bow will fit many archers who may have different lengths of draw.

All bows should be equipped with an arrow rest in good condition and with a proper-length, well-served, 10- to 12-strand string with properly placed nock locator.

Always inspect the bow for cracks and splinters, and the condition of the bowstring and serving.

A universal draw length bow is popular in youth programs because it provides all the advantages of a compound bow but with an adjustable draw weight to accommodate participants of all abilities.

True compound bows are not recommended at this level because they must be set up to fit each individual archer.

**Arrows.** Care should be taken to inspect arrows before use.

- **Shaft material.** Wood arrows are light but susceptible to warping and splintering. Fiberglass arrows are heavier, and more durable, and will last several seasons. Aluminum arrows are light and shoot true, but cannot be repaired if bent or kinked. Carbon fiber arrows are lighter, stronger, and preferred by most competitive shooters.
- **Length.** An appropriate length arrow for Cub Scout age youth will be approximately 24 to 26 inches. For Scouts BSA use will be approximately 26 to 30 inches. For Venturers and Sea Scout use, arrows will be approximately 28 to 32 inches. Care must be taken to avoid shooting an arrow that is too short for the archer or too short for the bow.
- **Point.** Arrows must be fitted with target points. No field points or broadheads.
- **Nock.** The nock should fit the serving of the bow being used. The arrow should not fall from the string if the nock opening is correct.
- **Fletching/vanes.** Either may be used; however, plastic vanes provide longer service with young participants.

#### **Personal protection.**

- **Quiver.** For each archer, either a personal side quiver or a ground quiver must be provided to store arrows during shooting.
- **Finger protection.** Archers must wear a finger tab or glove unless there are “no gloves” on the string.
- **Arm protection.** Each archer **must** wear an arm guard on the bow arm. Arm guards may be obtained in junior sizes for small arms.
- **All protective equipment must be properly sized for the archer.**

**Sights.**

- Not recommended for Cub Scouts.
- As the fundamentals of archery are learned, it is recommended that sights be added to the bow. Least expensive may be a simple quilter's pin affixed at the sight window by foam tape applied to the back of the handle.
- Relatively inexpensive target sights may be added to the bow, which will be a tremendous aid to the shooter for qualifying or competition.

**Targets.**

**Cub Scouts.** It is recommended that large-diameter target mats and faces be used to ensure success and to reduce the number of lost arrows. Ethafoam mats are commercially available in 48-inch, 36-inch, and 32-inch diameters, with five-color target faces to match. Animal, zombie, and human silhouettes are not approved for Cub Scout use.

Set the target line at no more than 10 yards in front of the shooting line, adding to the success of young archers. The mat should be mounted relatively low to the ground to make it easier to extract arrows from the target.

**Scouts BSA.** It is recommended that large-diameter target mats and faces be used to ensure success and to reduce the number of lost arrows. Ethafoam mats are commercially available in 48-inch, 36-inch, and 32-inch diameters, with five-color target faces to match. Scouts BSA participants are allowed to use tasteful and appropriate animal silhouette targets (paper and 3-D targets). Appropriate animal silhouette targets include wild game species that are normally hunted. Human form and zombie silhouettes are not approved for use.

**Venturers and Sea Scouts.** For new shooters, it is recommended that large-diameter target mats and faces be used to ensure success and to reduce the number of lost arrows. Ethafoam mats are commercially available in 48-inch, 36-inch, and 32-inch diameters, with five-color target faces to match. As Venturers and Sea Scouts develop skill, various target games and shooting distances may be introduced to provide a challenge for the participant. Venturers and Sea Scouts are allowed to use tasteful and appropriate animal silhouette targets (paper and 3-D targets). Appropriate animal silhouette targets include wild game species that are normally hunted. Human form and zombie silhouettes are not approved for use.



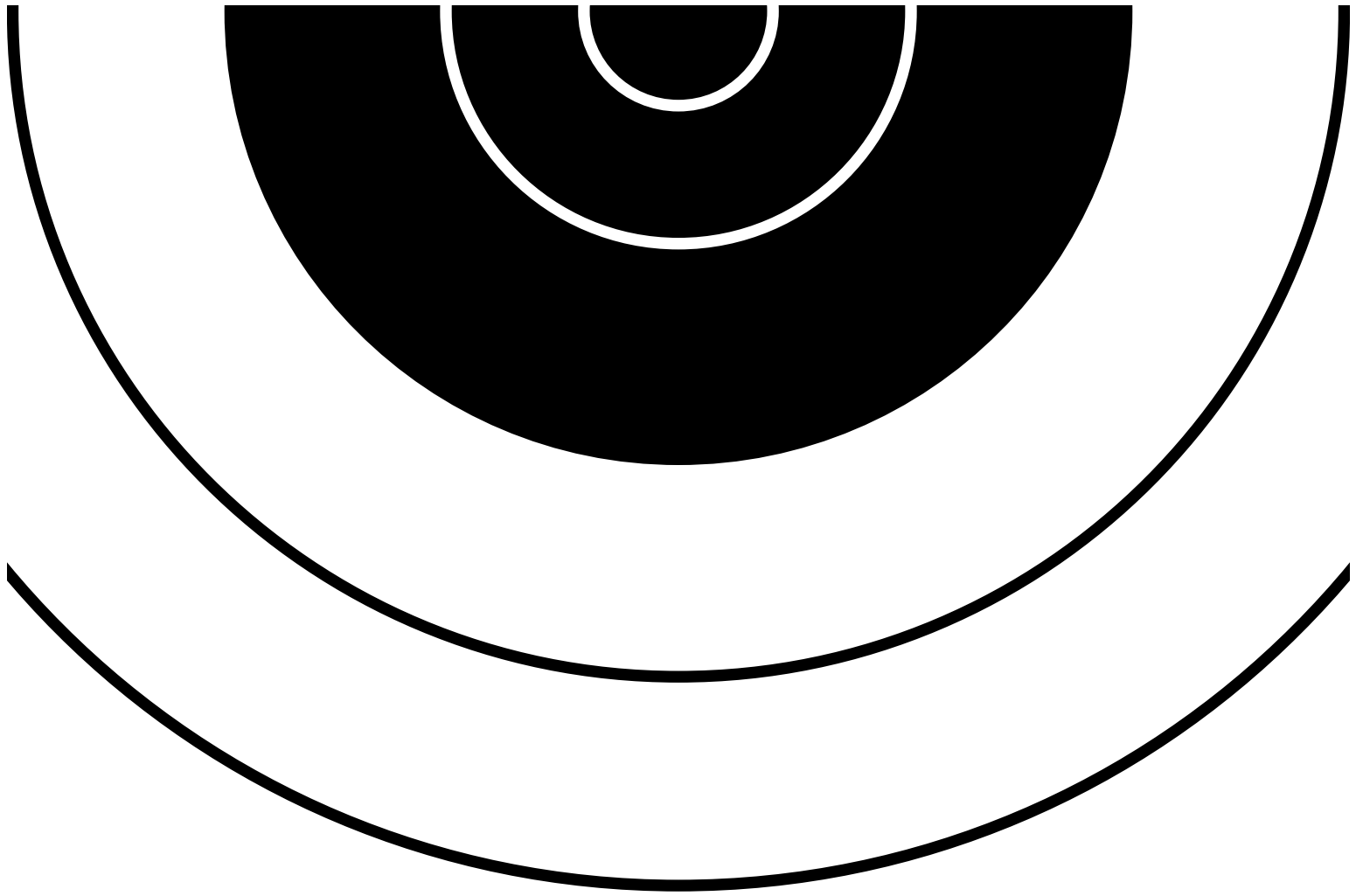

**SECTION III**  
**HEALTH AND SAFETY**



## CHAPTER 6: SAFETY

The Boy Scouts of America adheres to its longstanding policy of teaching its youth and adult members the safe, responsible, and intelligent handling, care, and use of firearms, throwing equipment and bow and arrow in planned, carefully managed, and supervised programs.

Safe gun handling is of paramount importance. You must treat every firearm as if it were loaded. With that in mind, there are several universal rules of safe gun handling that must always be followed.

1. **Always** keep the gun pointed in a safe direction.
2. **Always** keep your finger off the trigger until ready to shoot.
3. **Always** keep the gun unloaded until ready to use.

### Communications

Each range should have reliable communication with the appropriate staff overseeing the event or activity.

### Emergency Response Plans

A complete first-aid kit should be centrally located near the shooting ranges. The location of the first-aid kit should be prominently marked. In the event of an accident, the established emergency protocols for the camp or activity should be followed.

### National Camping Standards

For standards related to shooting sports and short-term and long-term camp operation and management procedures, refer to the current National Camp Accreditation Program Standards at [www.scouting.org/NCAP](http://www.scouting.org/NCAP).

### Standard Operating Procedures

All ranges must have their own written standard operating procedures (SOP) and have them posted at the range. See Appendix 3 for a sample of an SOP.

### Equipment Inspections—Firearms and Archery

Prior to range operation, equipment must be inspected for safety and proper function. This inspection includes the firearm or apparatus being used as well as all protective equipment. During this inspection if any equipment is deemed unsafe or not sized appropriately for the participants, it must not be used. These inspections should be in advance of the activity or camp so if needed, corrective action can take place.

### SAFE checklist

All shooting and throwing sports activities are expected to follow the BSA SAFE checklist. Leaders and staff conducting shooting sports activities must conduct this checklist prior to the event or activity. For a model SAFE checklist for shooting sports see the SAFE checklist at the beginning of this manual.

## CHAPTER 7: ADDITIONAL CONSIDERATIONS

### General

**Lead protection.** Lead is a soft, dense metal that is an integral part of most bullets. Lead is toxic to humans in relatively small concentrations, with the most susceptible organs being the eyes, central nervous system, and gastrointestinal tract. Handling ammunition, setting up a range for shooting, counting out rounds for firing, loading and unloading a firearm, discharging a firearm, and cleaning a firearm can all leave lead residues on the skin. Two easy precautions can minimize the risk of inhaling or ingesting lead residues. First, when handling ammunition or a recently discharged firearm, minimize contact of the hands with other parts of the body, particularly the eyes, mouth, and skin. When you are finished handling ammunition or firearms, immediately wash your hands with soap and cold water. It is strongly recommended that a handwashing station be next to all shooting ranges and storage areas where ammunition or firearms may be handled or used. Food and drink should not be permitted on a shooting range or in storage areas.

The use of lead can also be an environmental concern and may require some additional consideration for a local council or the landowner. Care needs to be taken to contain the impact of the shooting range on the environment.

Other environmental impacts: The discharge of a firearm can cause a loud report. This noise can also become an environmental concern when the range is close to neighbors or other land owners. Care must be taken in the selection of range locations keeping in mind the noise that could be caused in shooting.

**Cleaning solvents.** Solvents used for cleaning firearms typically contain petroleum distillates, ammonia, caustics, and other potentially hazardous chemicals. Hazards may include skin damage, lightheadedness caused by vapors, and risk of fire. In addition, once the solvent has done its job of cleaning a firearm, it not only contains the original chemicals, but now contains the residues from the firearm, which may include lead, copper, gunpowder, and burned plastic. As with lead, contact with the eyes, mouth, and skin should be discouraged while handling firearm cleaning solvents. Use of appropriate gloves and eye protection are strongly recommended when using any cleaning materials and solvents. Food and drink should not be allowed in areas where cleaning takes place. A hand washing station with soap and cold water should be available near the firearm maintenance/cleaning area.

**Considerations for people with disabilities.** Another consideration concerns participants who may have physical, intellectual, cognitive and/or developmental challenges. Every effort should be made to serve all youth and adults in Scouting. This may require modification of facilities, equipment, content delivery or processes. Safety is the number one concern. The question may need to be asked to how accommodations can be made so that any individual can shoot safely. Considerations to influence the course of action may include: What challenges are afforded by the disability? Does the participant have someone helping them? Can you communicate effectively with the participant and helper? Ask the participant, parent, and/or unit leader what is the best way to accommodate the participant (never assume disability is synonymous with inability). It may be necessary to temporarily close the range to other participants so you can work one on one on the range with a participant with the special need. Consideration must also be given to the provisions of the Americans With Disabilities Act.

For information about adaptive shooting with firearms reach out to [adaptiveshooting@nrahq.org](mailto:adaptiveshooting@nrahq.org) or [shooting-sports@scouting.org](mailto:shooting-sports@scouting.org).



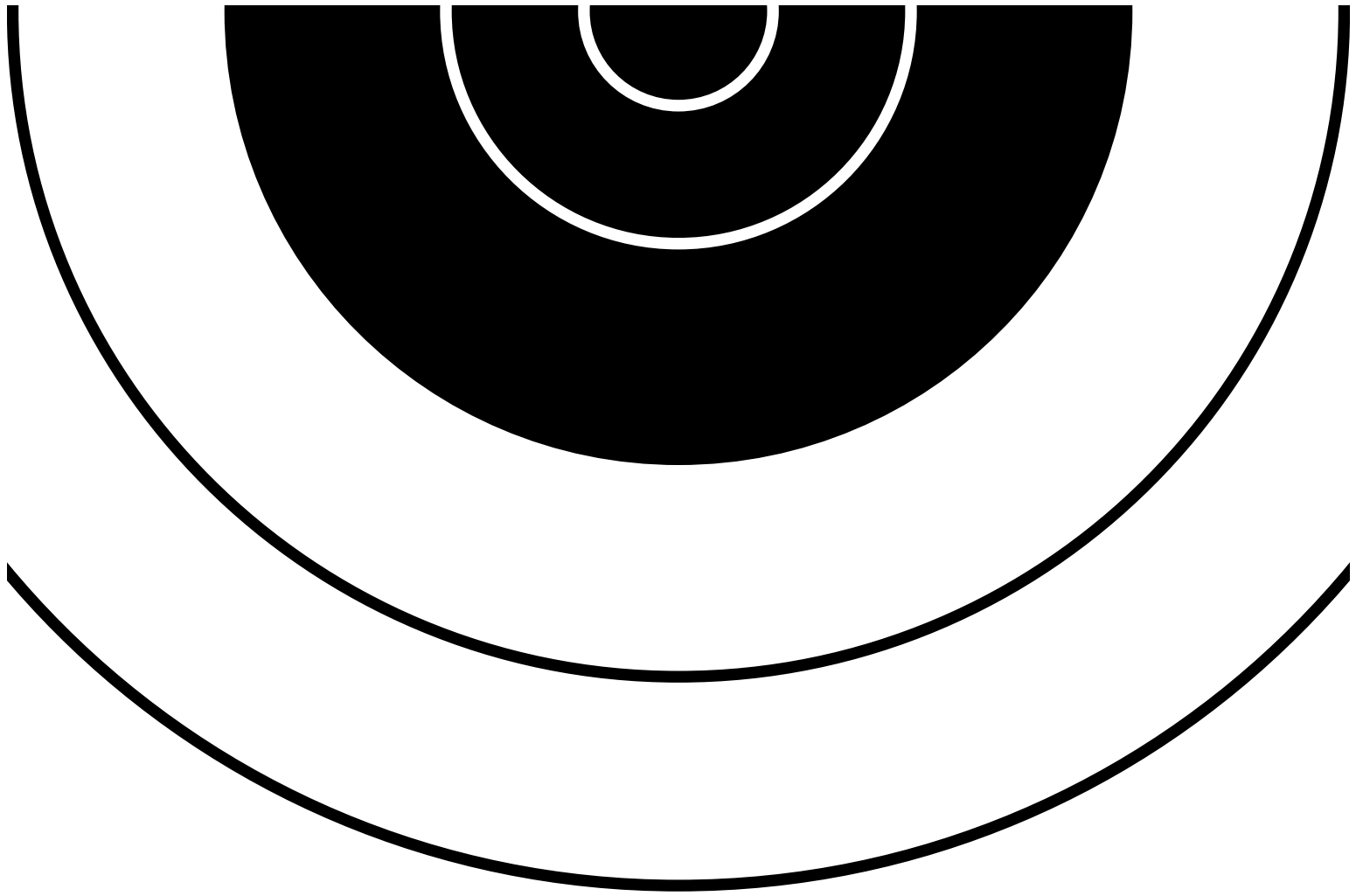

**SECTION IV**  

---

**TRAINING**



## CHAPTER 8: TRAINING COURSES

In Scouting events and activities, the BSA's primary consideration is the safety of its youth and adult members. To achieve that goal, the BSA, in consultation with other organizations, has created specific guidelines for the shooting sports. These organizations also provide training and instructor certification by discipline-specific subject matter experts to prepare those individuals who will serve in a leadership or supervisory role in the various shooting sports activities.

In general, for all certifying organizations, the instructor candidate must meet specific eligibility requirements, satisfactorily complete the instructor training curriculum, understand and agree to the responsibilities of a certified instructor, and maintain active certification status.

Listed here are the shooting sports training certifications recognized by the Boy Scouts of America.

### **BSA Training**

#### ***BSA National Camping School***

Annually, seven-day BSA National Camping Schools are conducted. The purpose of the National Camping School is to prepare Scouters who will be serving in management or supervisory roles in a council camp. Those who successfully complete the shooting sports section of the National Camping School, will be given a certificate of training as a BSA shooting sports director, which is valid for five camping seasons.

Participation must be approved by a local Scout executive, and enrollment is administered through the local council. For more information about National Camping School visit <https://www.scouting.org/outdoor-programs/national-camping-school/>

It is also expected that the BSA shooting sports director will serve the council as a resource year-round and be an active member of the council's shooting sports committee.

### ***Rangemaster Training***

Operation of BB, archery, and slingshot ranges for activities and events, including day camp, long-term camp, and short-term camping programs require qualified, trained Rangemasters.

BB/slingshot rangemaster and archery rangemaster training (2 separate courses) are administered by the council's shooting sports committee and conducted by a BSA National Camping School certified shooting sports director or a council approved currently certified National Rifle Association rifle instructor for the BB/slingshot rangemaster and a USA Archery instructor certification for archery rangemaster. In either case the instructor must be familiar with the BSA program for which they are instructing (ex. NRA rifle instructor must be familiar with Cub Scout shooting sports if instructing BB range course for Cub Scout BB rangemaster.)

These BB/Slingshot rangemaster and Archery Rangemaster certifications are valid for two years from the date of the training.

A currently certified NRA rifle instructor is qualified to serve as a BB/slingshot rangemaster only if that person is familiar with the program policies and delivery of the BSA program they will oversee. A currently certified USA Archery Level 1 instructor or higher may serve as the Archery Rangemaster for archery activities.

### **National Rifle Association Training**

#### ***NRA Certified Rifle Instructor***

A NRA Certified Rifle Instructor is required to provide instruction for BSA rifle shooting activities involving Scouts BSA, Venturers, and Sea Scouts.

The NRA rifle instructor may teach the BSA 30-Minute Rifle Briefing, the NRA FIRST Steps Rifle Orientation, BSA Rangemaster training, the Rifle Shooting merit badge using the BSA Rifle Shooting Merit Badge Teaching Guide, and the eight-hour NRA Basic Rifle Course.

A currently certified NRA rifle instructor is qualified to serve as a BB Rangemaster for BB shooting and sling shot shooting activities provided the individual is familiar with the programs of the BSA they will oversee.

### ***NRA Certified Shotgun Instructor***

An NRA certified shotgun instructor is required to provide instruction for BSA shotgun shooting activities involving Scouts BSA, Venturers, and Sea Scouts.

The NRA shotgun instructor may teach the BSA 30-Minute Shotgun Briefing, the NRA FIRST Steps Shotgun Orientation, the Shotgun Shooting merit badge using the BSA Shotgun Shooting Merit Badge Teaching Guide, and the eight-hour NRA Basic Shotgun Course.

### ***NRA Certified Pistol Instructor***

An NRA certified pistol instructor is required to provide supervision for BSA pistol shooting activities involving Scouts BSA, Venturers and Sea Scouts. Additional Scouts BSA Safety and Marksmanship training is required to supervise Scouts BSA pistol shooting activities.

The NRA pistol instructor may teach the BSA 30-Minute Pistol Briefing, and the eight-hour NRA Basic Pistol Course to Venturers and Sea Scouts.

### ***NRA Co-Op Muzzleloading Rifle Certified Instructor***

An NRA certified Co-Op muzzleloading rifle OR an NRA/NMLRA certified muzzleloading instructor is required to provide supervision for BSA muzzleloading rifle shooting activities involving Scouts BSA, Venturers, and Sea Scouts.

### ***NRA/National Muzzleloading Rifle Association Certified Muzzleloading Rifle Instructor***

The NRA certified co-op muzzleloading rifle or full NRA/NMLRA muzzleloading instructor is required to provide supervision for BSA muzzleloading rifle shooting activities involving Scouts BSA, Venturers, and Sea Scouts.

The NRA Co-Op muzzleloading rifle instructor or the NRA/NMLRA muzzleloading instructor may teach the NRA Basic Co-Op Muzzleloading Rifle Shooting Course and the muzzleloading option of the Rifle Shooting merit badge.

The NRA co-op muzzleloading rifle instructor may teach the NRA Basic Co-op Muzzleloading Rifle Shooting Course, and the Muzzleloading option of the Rifle Shooting merit badge.

### ***NRA/National Muzzleloading Rifle Association Certified Instructor***

An NRA/NMLRA certified muzzleloading instructor is required to provide supervision for BSA muzzleloading shotgun shooting activities involving Scouts BSA, Venturers, and Sea Scouts.

The NRA/NMLRA muzzleloading instructor may teach the NRA Basic Muzzleloading Shooting Course and the muzzleloading option of the Shotgun Shooting merit badge.

An NRA/NMLRA certified muzzleloading instructor is required to provide supervision for BSA muzzleloading pistol shooting activities involving Venturers and Sea Scouts only.

The NRA/NMLRA muzzleloading instructor may teach the NRA Basic Muzzleloading Shooting Course to Venturers and Sea Scouts.

### ***NRA Range Safety Officer***

An NRA Range Safety Officer is required to provide live firing range supervision for all shooting activities involving Scouts BSA, Venturers, and Sea Scouts. No other certification is accepted.

The NRA Range Safety Officer is responsible for the range management.

### ***NRA Chief Range Safety Officer***

An NRA chief Range Safety Officer or an NRA training counselor is qualified to teach the NRA basic Range Safety Officer course. The Chief Range Safety Officer may also assist Scouting activities in the role of the Range Safety Officer. This person may also be responsible to approve private/public range use for a council or unit activity.

### ***NRA Training Counselor***

Qualified, experienced, certified instructors may apply for appointment as a training counselor to recruit and train new instructors to teach basic firearms training courses. For information about becoming a NRA training counselor visit [www.nrainstructors.org](http://www.nrainstructors.org).

## **Archery Training**

### ***USA Archery Level 1 Instructor***

The USA Archery Level 1 Instructor Certification course is administered by USA Archery, the national governing body for the Sport of Archery in the U.S., USA Archery, the National Field Archery Association and the Archery Shooters Association jointly recognize all certification levels.

Candidates for the USA Archery Level 1 instructor certification are primarily camp archery staff and those working with entry-level students. The USA Level 1 Archery Instructor Certification Course provides graduates the necessary tools to maintain a high level of safety both on and off the archery range. The Level 1 Instructor will learn about range safety, range setup, the steps of shooting, equipment and repair, programs

and lesson plans and is well prepared to teach beginner archery programs to people of all ages and abilities in a variety of disciplines.

USA Archery Level 1 Archery Instructors may teach the Basic Archery course and the Archery merit badge.

In addition, the certified instructor may serve as a Rangemaster for a Cub Scout archery activity.

### ***USA Archery Level 2 Instructor***

The Level 2 Archery Instructor Certification Course includes the USA Level 1 Archery Instructor Certification Course and provides students with an introduction to the National Training System (NTS) Steps of Shooting for recurve and compound, equipment and accessory setup, athlete development and events. Candidates for the Level 2 instructor certification are instructors age 18 and older and Level 2 instructors may also take an online course to become a USA Archery Instructor Trainer so that they may train USA Archery Level 1 and USA Archery Level 2 instructors.



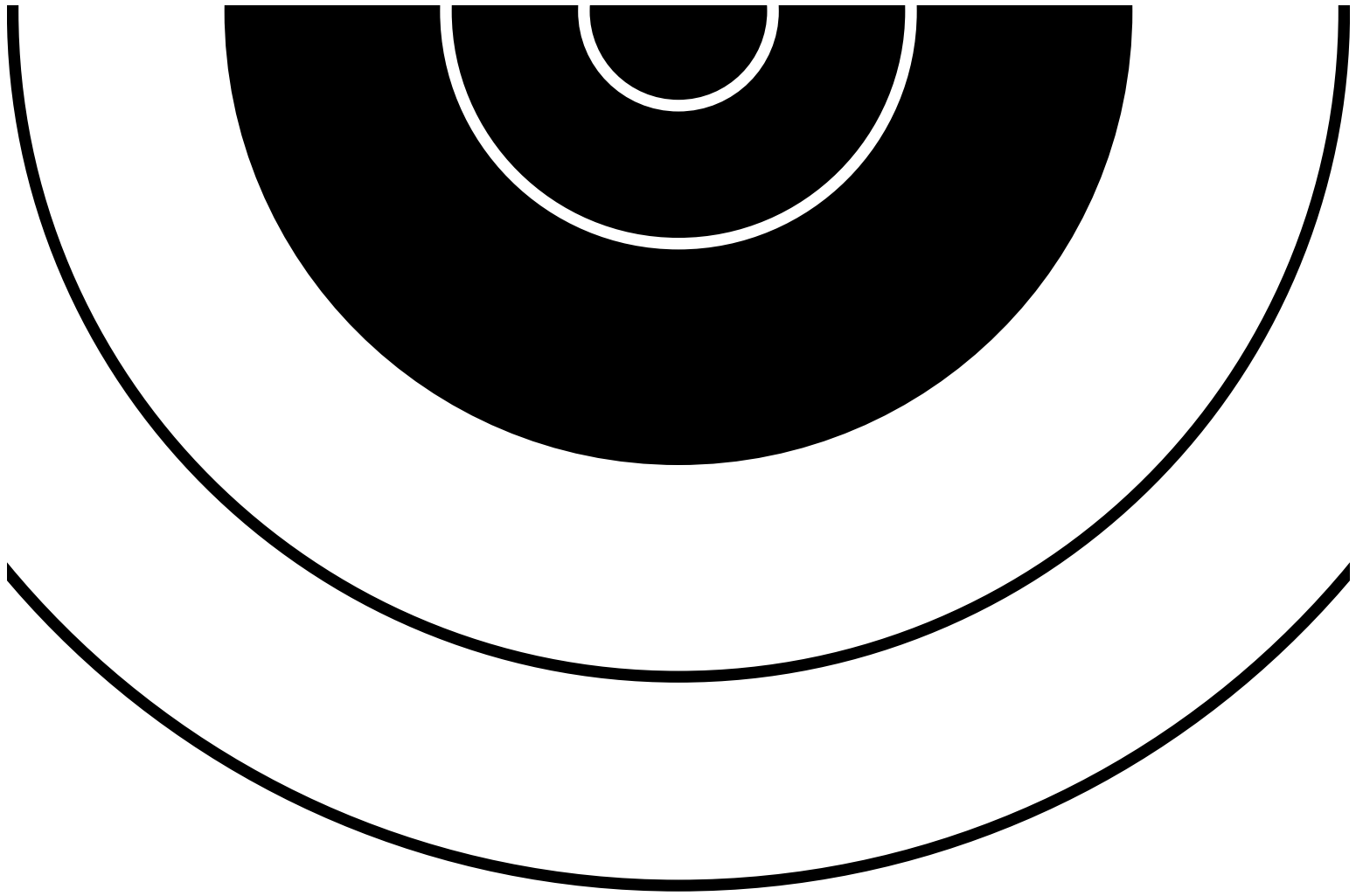

**SECTION V**  
**ARCHERY AND BB GUNS FOR CUB SCOUTS**





## CHAPTER 9: INTRODUCTION

Archery, BB gun, and sling shot shooting for Cub Scouts and Webelos Scouts are restricted to District or Council organized day camps, Cub Scout/Webelos Scout long term camp, short term camp or to council activities held on or off BSA property where the district or council provides currently trained BSA shooting sports Rangemasters and all standards for BSA shooting sports are enforced.

Archery, BB gun, and sling shot shooting for Cub Scouts and Webelos Scouts are prohibited at the pack level or den level. A multi-pack or multi-den event is not to be considered a district or council activity.

Shooting sports awards for Cub Scouts may be earned only at the camps and activities listed above.

These programs are designed to emphasize safety and marksmanship development under the direction of trained Rangemasters using nationally approved instructional methods.

This section is for the BSA shooting sports director with archery and/or NRA rifle certification or for NRA instructors or USA Archery instructors who will teach the shooting sports skills of archery, BB gun or sling shot shooting to Lions (archery and sling shot only) and Tigers with their adult partners, Cub Scouts, Webelos Scouts and Arrow of Light Scouts. There is potential danger to the untrained participant and others. “Safety through skill” is the watch phrase.

Special facilities and supervision are required for shooting sports. Camp properties of local councils become the center for most of these activities.

Shooting sports training provides fun and adventure for youth. Archery, BB gun and sling shot shooting teach skills, discipline, self-reliance, sportsmanship, and conservation, all of which are elements of good character valued by the BSA.

Adventure beckons when Lions and Tigers with their adult partners, Cub Scouts, Webelos Scouts and Arrow of Light Scouts have mastered the skills of shooting sports. Mastery of these skills will help a youth feel confident in their abilities.

The council’s camping property usually is an ideal location for shooting sports areas. Here, safely designed areas may be established for the Cub Scout shooting sports program. Under qualified leadership, Lions and Tigers with their adult partners, Cub Scouts, Webelos Scouts, Arrow of Light Scouts and parents may be given the opportunity to participate in these activities.

Other community resources such as the local chapter of the National Rifle Association, archery clubs, and sports groups will often provide facilities and resources.

The skills needed to master shooting sports adds color and variety to the Cub Scout program. These activities can become a natural part of our camp setting.

### Leadership

In camp, leadership for shooting sports needs special attention by the camp director and their program director. Staff members must be certified per BSA qualifications for these activities and must be at least 18 years old with mature judgment and the ability to teach. In Cub Scout/Webelos Scout day camp, long-term camp, or short-term camps, the staff should be members of the program staff. Volunteer experts who come to camp for shorter periods may supplement their work.

All shooting ranges in the Cub Scout program must be supervised by a qualified Rangemaster who is at least 18 years old and who meets the minimum state requirements. See specific qualifications and training requirements for archery Rangemaster and for BB gun and slingshot Rangemasters starting on page 125.



# CUB SCOUT SHOOTING SPORTS ACTIVITIES

## BB Gun Shooting – Cub Scouts

BB gun shooting is an exciting, worthwhile activity for Scouts, and it is one of the most popular program activities held at camps. BB gun shooting provides fun and adventure, yet also teaches skills, discipline, self-reliance, and sportsmanship. We will teach Tiger Cubs with their adult partners, Cub Scouts, Webelos Scouts, and AOL Scouts how to use BB guns safely. (*Lion Cubs are NOT allowed to use BB guns.*)

Intelligent, supervised use of BB guns is consistent with the principle of “safety through skill.”

Approval has been given for BB gun (defined as a smoothbore spring-piston or air rifle propelling shot known as “BBs”) safety and marksmanship programs in district or council Cub Scout programs. **The barrel velocity must be 350 feet per second maximum.** Tiger Cubs and Cub Scouts are not permitted to use any type of handgun or any other type of or firearm.

**The use of pellet air rifles is restricted to Webelos Scouts in a long-term camp setting and qualifies when in compliance with the following:**

- The air rifle pellet gun range meets or exceeds BSA and NRA recommendations and appropriate BSA Outdoor Programs/Properties design standards. The range is on council-owned property.
- All air rifles are in good repair are provided. All air rifles used in BSA shooting sports have a trigger pull in excess of 2.5 pounds and are tested with a 2.5-pound weight or scale at least once a week while in use. If any trigger mechanism fails, the air rifle is immediately removed from service. Documentation of the tests is maintained.
- All air rifles (CO<sub>2</sub>, pump, break barrel, etc.) are limited to single-shot designated for target shooting, velocity of 500 to 540 feet per second, and energy levels not to exceed 7.5 joules.
- Safe, separate and locked storage (can be the same building) is provided for pellet guns, pellets, and CO<sub>2</sub> cylinders and bulk tanks.
- Air rifle propellant is limited to CO<sub>2</sub> cylinders or air compressor/scuba tanks. Refilling is conducted by qualified adults with appropriate controls. If scuba tanks are used, each tank must be visually inspected annually and hydrostatically tested every five years by a qualified technician.

### A Brief History of BB Gun

In ancient history, blowguns began to appear in many different parts of the world. Although crude, these primitive devices were very accurate. They were made from bamboo or other hollowed-out woods.

A blowgun is a tube into which a hunter blows to shoot a projectile out the other end. This idea was transferred into gun form somewhere in the 1500s. The bellows gun, invented around 1580, is the earliest known air-powered gun.

A few decades later, the first pneumatic (pump-up) air gun was created in France for King Henry IV. The nobility usually owned these early guns, since they were too expensive for commoners.

In the late 1700s, some units of the Austrian army were equipped with air rifles.

In America, records show that in the 1800s, Lewis and Clark had an air gun for hunting and impressing the native Americans. The native Americans called it “the smokeless thunder stick.”

In 1885, in the United States, the Markham Air Rifle Company became one of the first companies to sell BB guns. These pneumatic rifles eliminated bullets and used a small pellet the size of a ball bearing, soon to be called a “BB.”

A few years later, a company that sold steel windmills decided to also sell BB rifles. By 1895, this company had stopped producing windmills and made air rifles full-time and changed the company name to Daisy.

Daisy’s guns were mostly made of steel, which improved the gun’s strength and design. The Daisy air rifle became popular very quickly, and within five years Daisy had sold 250,000 BB guns. Soon, Daisy bought out all of its competition.

Daisy also promoted to youth by making special BB guns that related with popular historical characters like Davy Crockett.

In 1984, the Olympic Games featured air guns for the first time.

Today, BB guns are still being produced in both rifle and pistol forms and are very popular among all age groups.

### Leadership

BB gun shooting must be conducted by trained, qualified, on-site rangemasters who direct the operation of the range program and BB gun shooting instruction. The ratio of BB gun rangemasters to shooters is 1-to-8 on the firing line. To qualify as a BB gun rangemaster, the rangemaster must be at least 18 years old and be trained by a National Camping School-trained shooting sports director or a National Rifle Association rifle instructor.

The BB gun rangemaster also must be registered with the Boy Scouts of America.

The local council issues a Training Course Pocket Certificate, No. 33767, and keeps a record of those who have been certified. BB Gun Rangemaster, course code CS 32. Certification must be renewed every two years.

### **Training BB Gun Rangemasters**

This training is conducted by a National Camping School Shooting Sports Director. This training should be conducted on a BB gun range. Include a practical exercise on how to set up a BB gun range, referencing the diagram in this appendix for the range layout, and have the participants walk through the process of running the range.

The outline to train BB Rangemasters can be found in the appendix on page 126.

### **Training Cub Scouts**

The objective is to teach Cub Scouts how to use a BB gun safely, to teach basic BB gun shooting skills, and to have fun. They should have the opportunity to fire a BB gun during the first orientation period. This activity is not intended necessarily to produce expert marksmen.

The instructor must always be mindful of their responsibility to make safety thoroughly understood before, during, and after instruction and practice. At the same time they must have warmth, patience, and understanding for the Scout who finds the skill difficult to learn.

### **Teaching Tips**

The coach-pupil method is effective for all types of skill training and is particularly effective in shooting sports. To put this method into practice:

1. Put the BB gun in the Cub Scout's hand as soon as possible so they can understand the BB gun while the basics are explained.
2. Group participants into pairs (Scout and parent/guardian would be ideal).
3. The instructor demonstrates the activity or action to be followed before the whole group. When demonstrating techniques, be sure to do them correctly. The instructor then circulates among the pairs giving a word of advice or assistance, recognizing good work, correcting errors, and determining how well the participants understood the method.
4. The Scout practices while the parent coaches. Let Scouts shoot the first round. At a predetermined signal, reverse the roles. Progressively, participants are learning by observing, by doing, and by coaching.
5. Use a positive approach. Use praise sincerely. Before making a correction, question the fault to find the cause. Show the youth what they are doing wrong.

6. Avoid long discussions on the parts of the equipment used. Teach just enough so participants will know how to safely use the equipment.
7. Allow each Scout to feel the satisfaction of hitting a target as quickly as possible.
8. Scouts do not have to load one BB at a time and shoot before loading another BB. They can load at one time all the BBs they are given.
9. In the following outline, "Cub Scout BB Gun Shooting Training," the time needed to conduct each section is not indicated because it will vary depending on the number of Cub Scouts participating.

### **Cub Scout BB Training—Youth**

#### **Section I**

A. Safety Guidelines, page 55

B. Equipment, page 61

1. Review diagram of Spring-Piston Gun (*Ensure to cover stock, butt, trigger, trigger guard, forearm, muzzle, rear sight, and safety.*)
2. Targets (Refer to **Cub Scout Shooting Sports Guide**, No. 510-322, in Appendix 20 of this guide)
3. Maintenance
  - The BB Gun should be unloaded when stored.
  - The safety mechanism should be engaged.
  - The BB Gun should be protected from scratches or scraps from other guns.
  - The BB Gun should be locked or otherwise secured in a safe, dry location, separate from ammunition.

#### **Section II**

A. BB Gun Shooting Basics, page 56

1. Eye Dominance, page 56
2. Shooting Shoulder, page 56
3. Breathing, page 56
4. Sight Alignment, page 56
5. Trigger Squeeze, page 56
6. Follow-Through, page 57

B. BB Gun Shooting Practice Fun, page 59

#### **Section III (optional activities)**

A. Shooting Positions, page 57

1. Free-Arm Standing Position, page 57
2. Bench Rest Position, page 57
3. Prone Position, page 58
4. Sitting Position, page 58

B. BB Gun Shooting Games and Activities, page 59

C. Cub Scout Awards (Refer to **Cub Scout Shooting Sports Guide**, No. 510-322, in Appendix 20 of this guide)

## Tiger Cubs and BB Gun Shooting

Tiger Cubs and their adult partners may participate in BB gun shooting activities. The adult partners must be included in all shooting activities. Each Tiger Cub must be paired with their adult partner before being allowed to shoot. In most cases, when Tiger Cubs and their adult partners participate in BB gun shooting, it will be at a day camp.

Keep in mind that youth of this age have very short attention spans (20 to 30 minutes maximum), and tire easily. They probably have little previous experience working as a group and may require more time to understand how the range operates. Tiger Cubs have a wide range of ability and experience levels, so be ready for anything!

### Safety Guidelines

When training youth to shoot, be sure to have proper equipment, secure and safe ranges, and clear safety instruction.

Gun safety is a simple but continuous process. Youth must first learn about safe gun handling. Safe handling skills are developed through practice. The most important safety element is attitude. All the safety knowledge and skills are of little value unless they are used. Being safe means consciously keeping a BB Gun under control.

Before handling any gun, a Scout must always get permission from their parent or guardian. If this is their first BB Gun shooting experience, they should sit down with an adult and discuss under what circumstances the gun can be handled. They must understand that the BB gun is not a toy.

Before using a gun:

- Always get permission from your parent or guardian.
- Always have an adult present when you use a gun.
- Know how the gun works and how to use it.
- Always be sure of your target and what is beyond the target.
- Always wear eye protection.
- Never reuse BBs.

These basic rules apply to handling a BB Gun under any circumstances:

1. **Always keep the gun pointed in a safe direction.** This is the primary rule of gun safety. "Safe direction" means the gun is pointed so that even if it were to go off, it would not cause injury or damage. The key to this rule is to control where the muzzle or front end of the barrel is pointed at all times. Common sense dictates the safest direction depending on circumstances.
2. **Always keep your finger off the trigger until you are ready to shoot.** When holding a gun,

rest your finger along the side of the gun or the trigger guard. Until you are actually ready to fire, do not touch the trigger.

3. **Always keep the gun unloaded until ready to use.** When you pick up a gun, carefully point it in a safe direction. Engage the safety, if possible. Then, while keeping your finger off the trigger, open the action and look inside the chamber(s) to make sure it is clear of ammunition. If the gun has a magazine, remove it before opening the action and make sure it is empty. If you do not know how to open the action or inspect the chamber(s), leave the gun alone and get help from someone who does.
4. **Know how to use a gun safely.** Before handling a gun, learn how it operates. Know its basic parts and how to safely open and close the action. Know how to remove ammunition from the gun or magazine.
5. **Be sure the gun is safe to operate.** Just like other tools, guns need regular maintenance to remain in good working order. Regular cleaning and proper storage are part of the gun's general upkeep. If there is any question about a gun's ability to function, then do not use it. Get someone to fix it!
6. **Use only the correct ammunition for the gun.** Only the BB designed for a particular BB gun can be fired safely in that gun. Do not shoot the gun without loading the proper ammunition.
7. **Wear eye protection.** Always wear eye protection. Shooters and instructors should wear approved safety goggles at all BB gun ranges. BBs may ricochet.
8. **Never use alcohol or drugs before or when shooting.** Alcohol or any other substance likely to impair normal mental or physical function must not be used before or while handling or shooting guns. This may include prescription medications.
9. **Most guns have a mechanism called a safety** that helps prevent the gun from accidentally firing. However, a safety is a mechanical device, which can and will fail. Shooters must be trained that the safety mechanism is not a sure, safe way to prevent a gun from firing. Many accidents have occurred because shooters have relied on the safety mechanism to work.
10. **Although not mandatory for BB gun shooting, ear protection may also be worn.** Shots fired from guns are loud, and the noise could damage the hearing of some shooters.
11. **Know your target and what is beyond the target.** Be absolutely sure to identify the target beyond any doubt. Equally important, be aware of the area beyond the target. Never fire in a direction where there are people or where any other potential for mishap might exist. Think first. Shoot second.



12. **Store guns so they are not accessible to any unauthorized person.** Deciding where and how to store guns and ammunition depends on several factors and include security and accessibility. Safe and secure storage means untrained individuals (especially children) are denied access to guns and ammunition.

### ***What Causes Gun Accidents?***

Most air gun accidents are caused by ignorance and/or carelessness.

- Ignorance: A lack of knowledge
- Carelessness: A failure to use knowledge

### ***Safety Reminders***

What should a Cub Scout do if they find a gun in another place?

- STOP!
- DON'T TOUCH!
- LEAVE THE AREA!
- TELL AN ADULT!

### ***Sun Safety on the Shooting Range***

The American Academy of Dermatology advises the following protection tips against damaging rays:

- Limit exposure to sun between 10 a.m. and 4 p.m. when the sun's rays are the strongest.
- Generously apply sunscreen with a sun protection factor (SPF) of at least 15 and reapply it every two hours when outdoors, even on cloudy days.
- Wear protective, tightly woven clothing, such as a long-sleeved shirt and pants.
- Wear a hat with a wide, 4-inch brim and sunglasses with UV protective lenses.
- Stay in the shade whenever possible.
- Avoid reflective surfaces, which can reflect up to 85% of the sun's damaging rays.

### ***BB Gun Shooting Basics***

#### ***Eye Dominance***

Before shooting a gun, the participants should determine which eye is dominant. Just as people are either right- or left-handed, one eye is more dominant than the other. Discovering which eye a shooter favors is important because it could determine on which side the gun is held.

To find which eye is dominant, have participants extend both arms in front of them and form a small hole with their thumbs and index fingers. Instruct them to look at a distant object through the opening and then pull their hands back to their face. The eye that is in line with the object is dominant.

Assign youth, leaders, and parents in pairs to assist each other, then have them check with the rangemaster.

### ***Shooting Shoulder***

It is recommended that a shooter use the shoulder that is on the same side of the body as the dominant eye. If the right eye is dominant, place the firearm against the right shoulder. If the left eye is dominant, use the left shoulder.

### ***Breathing***

When shooting, stop breathing before firing a shot. Breathing causes the body to move and makes it difficult to maintain a steady sight picture. Before firing, relax and get comfortable. Then exhale and stop breathing. This technique will help shooters aim by reducing the body and rifle movement in relation to the target. Do not stop breathing for longer than eight to 10 seconds while aiming at the target. If you are not able to shoot within that time, stop, take a breath or two, and repeat the process.

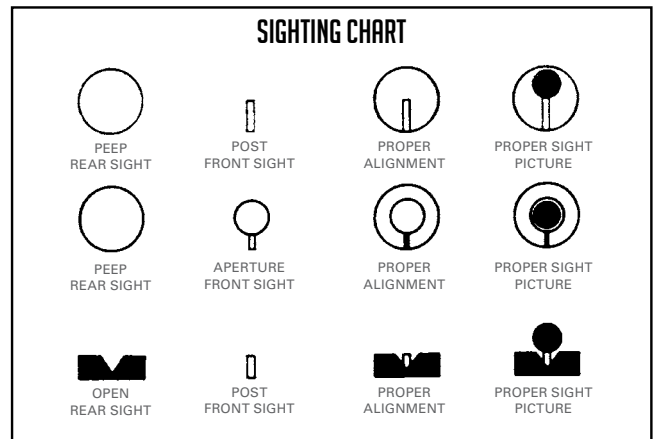

### ***Sight Alignment***

The shooter must learn proper sight alignment. This is the relationship of the front and rear sights to the eye. The shooter's dominant eye must be lined up with the front and rear sights, and the sights must be positioned so the front sight device is aligned properly with the rear sight.

Proper sight alignment is a key to accurate shooting. Any misalignment of the front sight with the rear sight introduces an angular error that is multiplied with distance.

A correct sight picture is obtained by achieving the proper alignment and then putting the aligned sights into their proper relationship with the target.

Focus should be on the front sight.

### ***Trigger Squeeze***

Trigger squeeze is the term used to explain how pressure is applied to the trigger. Some other terms commonly used are trigger pull, trigger control, trigger press, and trigger movement. While all these terms are correct, the preferred term is trigger squeeze because it accurately describes the smooth application of pressure required.

When ready to begin squeezing the trigger, the index finger should be on the trigger so the trigger is about halfway between the tip of the finger and the first joint.

The trigger must be squeezed straight back in a smooth, continuous manner without disturbing the sight alignment. Once trigger squeeze has begun, keep squeezing smoothly and continuously—do not speed up or slow down or apply pressure in a start-and-stop manner. Use the same type of pressure that would be used to squeeze a drop of liquid from a medicine dropper—a gradual, steady application of pressure until the drop finally falls. Just as it would be impossible to predict the instant the drop of liquid will fall, it should be impossible to predict the precise instant the gun will fire. Each shot should come as a surprise.

For best results, the trigger squeeze should be done as the shooter holds steady on the correct sight picture.

### ***Follow-Through***

The shooter must also master proper follow-through. Follow-through means to continue to do everything that was being done at the time the shot was fired. In other words, keep aiming until the BB hits the target.

The idea is to prevent any unnecessary movement before the projectile leaves the barrel. Because an air gun takes longer to send a projectile out of the barrel, proper follow-through is particularly important.

### ***Shooting Positions*** (All positions are described for right-handed shooters. Reverse for left-handed shooters.)

Proper body position is essential to achieve a good shooting score. When learning any shooting position, these basic steps must be followed:

1. Study the position.
2. Practice the position without a gun. (Learn to put the feet, legs, body, head, and arms in the correct position without holding a gun.)
3. Practice the position with a gun.
4. Align the position properly with the target.  
Adjust the position so the gun points naturally at the target.
5. Shoot from the position.

### ***Free-Arm Standing Position***

#### **Body position:**

- **Feet.** Stand with feet shoulder width apart and body weight evenly distributed.
- **Body and head.** Keep the body and head comfortably erect.
- **Face.** Place your cheek against the stock so you are looking down the barrel.
- **Knees.** Keep the knees straight but not locked.
- **Left arm.** Rest the left arm against the rib cage to support the rifle.

- **Left hand.** Place the left hand under the fore-end of the rifle to support the weight of the rifle.
- **Right hand.** Grasp the rifle grip with the right hand.
- **Right shoulder.** Position the rifle butt against the right shoulder so the sights are at eye level.



**FREE-ARM  
STANDING POSITION**

### ***Bench Rest Position***

#### **Body position:**

- **Body & Feet.** Seated at the bench. Body leaning forward slightly, and feet flat on the floor.
- **Head.** Keep the head comfortably erect.
- **Face.** Place your cheek against the stock so you are looking down the barrel.
- **Left arm.** Rest the left elbow against the bench to support the rifle.
- **Left hand.** Place the left hand under the fore-end of the rifle to support the weight of the rifle.
- **Right hand.** Grasp the rifle grip with the right hand.
- **Right shoulder.** Position the rifle butt against the right shoulder so the sights are at eye level.



**BENCHREST POSITION**

### ***Prone Position***

#### **Body position:**

- **Body.** Lie on the ground, facing the target and angles slightly left.
- **Right knee.** Slightly bend the right knee.
- **Right leg.** Draw the right leg up, keeping it parallel to the back, and place the right foot on the ground.
- **Face.** Place your cheek against the stock so you are looking down the barrel.

- **Left elbow.** Extend the left elbow forward.
- **Left hand.** Hold the fore-end of the rifle with the left hand.
- **Right hand.** Grasp the rifle grip with the right hand.
- **Right shoulder.** Position the rifle butt against the right shoulder so the sights are at eye level.



**PRONE POSITION**

### *Sitting Position*

#### **Body position:**

- **Body.** Sit cross-legged at a 45-degree angle to the line of fire.
- **Feet.** With the sides of the feet flat on the ground, rest the calves on the upper sides of the feet.
- **Elbows.** Rest both elbows on the legs just in front of the knees.
- **Face.** Place your cheek against the stock so you are looking down the barrel.
- **Left hand.** Hold the fore-end of the rifle with the left hand.
- **Right hand.** Grasp the rifle grip with the right hand.
- **Right shoulder.** Position the rifle butt against the right shoulder so the sights are at eye level.



**SITTING POSITION**

### **Basic Shooting Activity**

This shooting activity covers many of the basic fundamentals needed in shooting a BB gun. Pair Scouts and adults as shooters and coaches.

1. Greet the participants.
2. Bring the participants onto the range.
3. Show the gun and say “This is a BB gun.”
4. Point to the barrel and say, “This is the barrel.”
5. Point to the muzzle and say, “This is the muzzle. It is the end the BB shoots out.”

**Always keep the gun pointed in a safe direction.**

6. Point to the action and say, “This is the action. It has the trigger—the part you squeeze to shoot.”

**Always keep your finger off the trigger until you are ready to shoot.**

7. Say, “The action also has the chamber where you put the BB to load the gun.”

**Always keep the gun unloaded until ready to use.**

8. Point to the stock and say, “This is the stock.” Then demonstrate how to hold the gun: Put the butt of the stock against your shoulder, hold the grip with the hand of the same arm, keeping your finger off the trigger and pointed in the same safe direction as the gun. Hold the forearm with your other hand.
9. Say, “You will use the free-arm standing position like this.” Demonstrate the position that is recommended for your range.
10. Have everyone on the range put on eye protection, either safety glasses or goggles.
11. Say, “Shooters, please move forward at my command.” Then give the command, “ON THE FIRING LINE.”
12. Assume the shooting position.
13. Have shooters pick up their guns, keeping them pointed in a safe direction downrange.
14. Have shooters again assume the shooting position, this time with the gun, and look through the sights. Explain how the sights are used.
15. Once all shooters know how to assume the shooting position and how to properly hold the gun, explain and demonstrate how to charge the gun.
16. Have shooters load BBs into the chamber. (Explain further.) Close and ready the gun.
17. Return to your shooting position. Note that everyone can make ready and load the gun.
18. Give the command “READY ON THE FIRING LINE.”
19. When shooters are in the ready position, give the command “COMMENCE FIRING.” Shoot all your five shots.
20. Watch for safety and help as needed.
21. Give the command “CEASE FIRE.” Everyone is to stop shooting.
22. Give the command “CLEAR ALL GUNS.” Have everyone clear their gun.
23. Explain and demonstrate how to make a gun safe. Explain how to ground the gun for position and range.

### **BB Gun Shooting Games and Activities**

A variety of games or activities can be done with BB gun shooting skills. Different ranges could be set up to play a particular game or courses could be set up where



participants go from station to station. BB gun shooting games and alternate activities work well, especially when youth are in camp for more than one day or if a council sponsors a special BB gun shooting camp for Cub Scouts. Shooting games are designed to improve shooting skills. Remember—safety is a must.

The following games and activities are appropriate for Tiger Cubs with their adult partners, Cub Scouts, Webelos Scouts and Arrow of Light Scouts.

### Fun Target Activities

- Make 8.5-by-11-inch targets with several squares on each. Put a number in each square. Shooters can see the squares but not the numbers in them. After firing at the page, the shooter adds up the numbers from the squares that their BBs hit. The highest score is the winner.
- Place dots on a target, then shoot at the back side of the target. Count the score from the dotted side.
- Suspend table tennis balls in a box to use as targets.
- Create a target by taping round candy to the back of a box. When the target is hit by the BB the candy shatters.
- Set up balloons as targets.
- Set up crackers as targets. Have participants shoot at the narrow edges of the crackers.

### Tic Tac Toe

Place three rows of three balloons on a target mat. Divide the group into two lines and have them stand in a single file 20 feet from the target. At the signal to shoot, each shooter will shoot one BB and step back. The second and each succeeding person will shoot one at a time. The first team to break three balloons in any line is the winning team.

### BB Gun Shooting Practice Fun

A practice station is a simple, basic BB gun shooting range, but is very fun for the boys. Many Cubs have few opportunities to shoot guns, so having the opportunity at a council camp or event to practice is a great experience for them.

Discuss and emphasize the primary rules of proper gun handling. Point out that all guns are potentially dangerous.

Practice the following skills:

- Have participants always point the muzzle in a safe direction and to be sure of their target.
- Show how to handle a gun while standing and when walking.
- Demonstrate and practice various gun-handling situations—how to pass the gun to another person, how to cross a fence with it, how to store it in an automobile, and how to get in and out of a boat

with it. Use real or artificial situations, but use the Scouts as demonstrators and require them to practice with others watching.

- Review sight pictures and sight alignment. Give reasons for sighting in a gun before shooting. Tell how little mistakes in sight alignment cause big misses on the target.
- Explain sight adjustment—move the rear sight in the direction you want the BB to go.
- Have relays, prone position without magazine, using sling or sandbag and paper targets.
- Explain the use of BB dishes.
- Demonstrate sitting, kneeling, and standing shooting positions.
- Shoot five rounds per Cub Scout using the standing position.

### Range Layout

**A sample outdoor BB Gun range layout is included at the end of this section.** Safety is a primary concern when operating a BB Gun range, and all safety rules must be followed.

If at all possible, the range should be laid out so shooting is done in a northerly direction so shooters are never facing the sun.

#### *Shooting on a Safe Range*

A safe range must have three things:

1. A safe area.
2. A safe distance
3. A safe backstop

1. **Safe area.** Whether inside or outside, be sure the range is set up so no one can accidentally walk in front of the firing line. When indoors, make sure doors and side windows are locked. When outside, make sure to always shoot in a safe direction. In either case, never point the gun toward windows or where people might walk.
2. **Safe distance.** Maintain at least 15 feet between the shooter and the target.
3. **Safe backstop.** A backstop to trap BBs and hold the target can easily be made from a large cardboard box. Do not shoot at a hard surface that could cause a ricochet. If using a tarp as a backstop, it is important to verify that the tarp is made of a heavy canvas material and not a thin plastic canvas material. It is best to hang the material at a 45-degree angle. Bales of straw also work well.

**Important!** Arrange facilities so there is no possibility of non-participants inadvertently walking behind the targets while shooting is in progress! No one may stand directly in front of the target while shooting is in progress!

**Inflatable Ranges** (Only commercially manufactured equipment is allowed to be used.) *(A BSA certified BB Gun Rangemaster or individuals specified in NCAP standard SQ 407 must supervise the range.)*

If an inflatable range is utilized, appropriate side and rear boundaries must be in place. (Minimum 10 ft. on the side, 15 ft. behind the target zone and 15 feet behind the shooting line.) There must also be a distinct gated entrance to access the shooting line. *(Manufacturers guidelines must always be followed if they are more stringent.) (You may only use manufacturers recommended equipment.)*

### Range Operation Rules

When operating the range, the safety rules must be remembered and constantly obeyed.

1. If the range is outdoors, fly a red range flag whenever the range is in use. The flag should be large enough and high enough on a flagpole to be seen from all approaches to the range.
2. Shooters reporting to the firing line will be issued a specific number of BBs and a BB dish that will be placed in plain sight at the firing point.
3. Shooters will be instructed that in case of a misfire the BB gun will be kept pointed at the target. The instructor will be called. If the malfunction is due to a broken part, the gun, after being cleared of BBs, will be removed from the firing line.
4. BB guns must be left with the action open or at half-cock, in the case of lever action spring-piston air guns, except when the shooter is in position on the firing line and has been given the command to load. (Half-cock position on a lever action spring-piston air gun is with the lever down, but without the spring compressed or cocked. To check to see if the gun is cocked, pull the lever forward; if there is no pressure on the lever, the spring is compressed and the gun is cocked.)
5. As soon as the command to cease firing is given, the BB guns must be opened and placed on the shooting mat with their muzzles pointing down-range, actions open or at half-cock, whether or not the shooter has completed firing all his shots. This rule must be enforced and obeyed absolutely.
6. In preparing to fire, the targets are first placed in position. The shooters then take their places on the firing line. While the first group is firing, the targets are prepared for the next group of shooters and they are told their firing point. When the first group has completed firing and all BB guns are unloaded and actions open or at half-cock, the fired targets are taken down and the new targets set up.
7. No one, shooter or instructor, is allowed in front of the firing line after the order has been given

to load and before the order has been given to cease firing—actions open.

8. No one is allowed on the firing line except the shooters and their coaches or instructors.
9. Horseplay of any kind is forbidden on the range. Spectators and those who are waiting their turn to fire are not permitted to do anything that may distract the attention of the shooters from the business of shooting accurately and safely.
10. All BB guns not in use should be kept in racks with the actions open or at half-cock.

### Sample Range Rules Poster



#### GENERAL SHOOTING RANGE RULES

1. This range may be opened only by a qualified BSA-certified range master.
2. All commands issued by the range master must be obeyed immediately.
3. Stay behind the firing line. Do not straddle the firing line.
4. Do not pick up a gun, bow, arrow, or slingshot unless told to by the range master.
5. Absolutely no running on the range.
6. No horseplay or unnecessary talking on the range.
7. If in doubt about the rules, ask your leader or range master for advice or help.

This poster can be found in the *Cub Scout Shooting Sports Guide*, No. 510-322, in Appendix 20 of this guide.

### Range Commands

When ready to start firing, the rangemaster commands: “ON THE FIRING LINE.”

Immediately, each shooter takes his assigned place at his firing point and prepares to fire, but does not load. The rangemaster checks the location of each shooter to ensure correct firing point and target number.

The rangemaster makes sure the range is clear, then asks: “IS THE LINE READY?”

If there is any shooter who is not ready or whose target is in bad order, that shooter immediately raises his arm and calls:

“NOT READY” and gives the number of his target.

The rangemaster will immediately call:

“THE LINE IS NOT READY.”

The rangemaster will investigate the difficulty and assist in correcting it. When the difficulty has been corrected, the rangemaster calls:

“IS THE LINE READY?”

If all is ready, the rangemaster then calls:

“THE LINE IS READY.”

(This means the line is ready on the right, ready on the left, and ready on the firing line.)

The rangemaster calls:

“LOAD.” Shooters load the BB gun chambers.

The rangemaster calls:

“READY ON THE FIRING LINE.”

The rangemaster commands:

“COMMENCE FIRING.”

After firing, the rangemaster commands:

“STOP FIRING — CLEAR ALL GUNS.” All BB gun chambers and magazines are unloaded and shooters leave the firing line with the actions of their BB guns open.

Repeat the above steps for all succeeding shooters.

The rangemaster will immediately command “STOP FIRING” if any incident occurs that could result in possible injury to some living thing should firing continue.

“AS YOU WERE” means to disregard the command just given. “CARRY ON” means to proceed with whatever was being done before the interruption occurred.

## Equipment

### Range Accessories

- Tarps to provide shade over the pads protecting the shooters and the guns
- BB dishes at each firing point
- Shooting mats at each firing point
- A desk with storage space for equipment for recording scores. It should be behind the ready line and near the bulletin board.
- Ample waste receptacles behind the firing line for fired targets and trash
- Sandbags or other rest equipment for each firing point
- Range flag and pole for use during range operation
- BB gun racks to store BB guns that are not in use

### Air Guns

Air guns, traditionally regarded as guns for beginners, are now enjoyed by shooting enthusiasts at all skill levels. Some, such as the familiar BB gun, are excellent for beginners, while other types are designed for the seasoned competitor. Whether used for recreation or sport, for field use or as an inexpensive training tool, air rifles are an excellent way to enjoy shooting.

In recent years, air guns have undergone dramatic improvements, making them more reliable, durable, and accurate. Air guns can be fired safely by shooters of all ages and experience levels on a wider variety of ranges than any other type of firearm.

## Spring Piston Guns

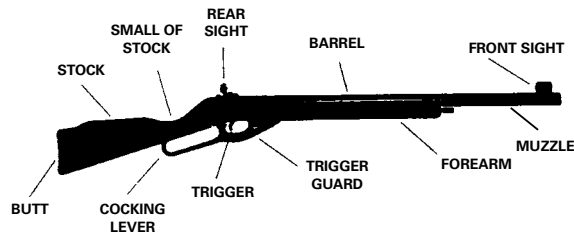

Spring-piston air guns use a manually operated lever, pivoting barrel, or other device to move a piston that in turn compresses a mainspring located in the frame or receiver portion of the gun.

When the piston is completely retracted, the mainspring is fully compressed. The piston will remain in this retracted position until the shooter releases it by pulling the trigger. The piston, under pressure from the compressed mainspring, moves rapidly forward when it is released, and compresses the air in front of it. The compressed air then forces the projectile out of the barrel.

In this type of air gun, the air that propels the projectile is not stored in a reservoir prior to firing; the air is compressed by the movement of the piston after the trigger is pulled.

## Pneumatic Guns

Pneumatic air guns use the principle of stored compressed air or gas and can be divided into two categories: single-stroke/multi-pump guns and compressed CO<sub>2</sub>/air guns.

### Air Gun Ammunition

There are five basic types of air gun ammunition: BBs, pellets, lead balls, darts, and bolts.

Keep BB Gun shooting equipment in good condition. Repairing guns and keeping target faces and mats in good condition can save money and make shooting experiences more successful.

### Eye Protection

Eye protection must be available for all individuals on a BB Gun range. The best ones are those with side shields.

### Backstops

Baled straw stacked behind the target will stop shots. Also, several layers of burlap, old canvas, or rugs hanging loosely over a horizontal pole or plank 1 or 2 inches wide will stop many shots. If tarps are used, check them for weakness during the season. Heavy duty moving blankets may also be used as long as it is monitored.

## Cub Scout Shooting Sports Awards

Cub Scouts earn the shooting sports awards in the following order:

1. **Rank-level patch.** Complete level 1 requirements. This involves participation in archery and acquiring basic knowledge of proper technique, safety, and operations. The patch is only awarded one per program (rank) year.



2. **Discipline device (pin).** Complete the level 2 requirements. This is designed to help a Cub Scout develop and demonstrate further skills, proficiency, and knowledge in BB Gun shooting. These skills are rank specific and provide a progression of skills appropriate for each age and rank of Cub Scouting.



## How To Set Up Outdoor Target BB Gun Range

Set up for wide-open, cleared space.

1. Select the Orientation of the Range
  - Avoid shooting into the sun by facing North.
  - The ground should be flat and free of obstacles.
  - Look for a natural backstop such as a berm to stop bb's. (If there is no berm, provide a minimum of 150 feet of open area behind the targets.)
  - The safety zone on the side should be 30-50 feet.
2. Place Range and Safety Lines
  - Rope, eco-friendly spray paint or chalk are ways to lay down the range lines outdoors. Follow the guidelines illustrated on the following page.
  - Shooting Line – The Shooting Line is between 15-30 feet from the Target Line depending on the skill level of the participants.
  - Waiting Line – Shooters stand behind the Waiting Line before and after shooting their arrows. It is meant to act as a safety area between the class and the Shooting Line. The Waiting Line is placed 15 feet behind the Shooting Line.

- **OPTIONAL: Controlled Access/Spectator Line** – Anyone who wants to watch archers shoot can gather behind this line. This line needs to be placed far enough behind the Waiting Line to prevent distraction from the spectators (at minimum 15 feet)

### 3. Set Up Targets

- Place targets in front of the natural berm. If a natural berm is not available, place targets in a wide-open space with a minimum safety zone of 150 feet behind the targets.
- Evenly space targets in front of the berm. Space between targets is dependent on placement of shooting positions.
- One method of hanging targets is to put up posts to hold “snow fence.” Attach the snow fence to the posts. Targets can be attached to the snow fence with clothes pins.
- A temporary target holder can be made using old political signs with their wire ground stands. (Paint over the political signs if they are used.)

### 4. Place the Equipment

- Eye protection should be available in the waiting area. All participants on the range must wear eye protection.
- BB Guns – May be on the top of the bench if using bench rest positions, or on the mat used for the prone positions. If shooters are shooting from the free-arm standing position, there should be some type of stand where the guns may be placed when not in use.
- BB's – Should be between the shooting line and the ready line under the control of the rangemaster.

## Outdoor Range Layout: Wide Open Space

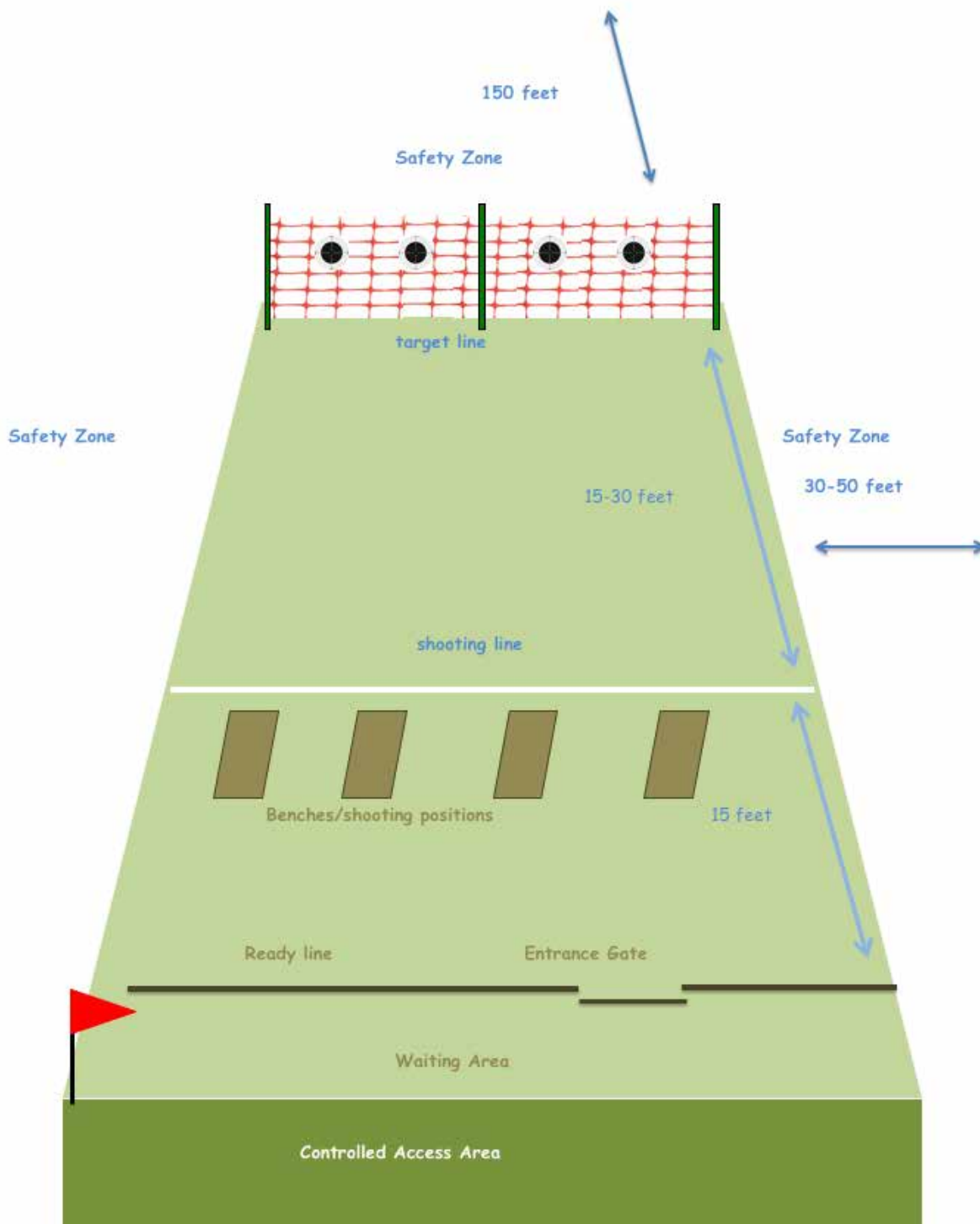



# ARCHERY

Archery is a colorful, interesting, and worthwhile activity for youth. The beginner gets immediate satisfaction yet finds a continuous challenge as they develop into a skilled archer. This activity provides good physical exercise and develops powers of concentration and coordination.

The goal is to teach Lion and Tiger Cubs with their adult partners, Cub Scouts, and Webelos and AOL Scouts how to use the bow and arrow safely. Archery is approved for all levels of Scouting.

## A Brief History of Archery

The advancement of civilization was enhanced by the use and discovery of bows and arrows. The bow and arrow provided a much safer way to hunt and made life easier.

Generally it is thought the spear was the predecessor to the bow. Spearheads have been discovered from many thousands of years ago.

A recognizable bow was discovered dating back to 6000 B.C. that was made from yew or elm.

Egyptians, somewhere around 3500 B.C. to 2800 B.C., are considered the first to use the bow in battle, which gave them superiority over their enemies. This bow was known as a composite bow.

Assyrians developed a shorter recurve bow that provided more power and easier handling around 1500 B.C. Crossbows were also used in ancient China.

About this same time, the Parthians became famous for shooting backwards while riding a horse. The term “Parthian shot” is still used today in archery.

Heracles, a Greek hero, was very well known for his help with the siege of Troy around 1260 B.C.–1240 B.C. As a direct result of Heracles’ help, the city of Troy fell through the use of the Trojan Horse.

Around 1200 B.C., a famous Egyptian pharaoh named Rameses II gave archery another boost by putting archers on chariots. This mobility allowed the Egyptians to defeat the Hittite army.

Through the course of time the wooden bow was made longer. The British were famous for improving on the bow, which eventually became known as the British longbow. The most famous battle of the longbow was the battle of Crecy in 1346. In 1500, crossbows were banned in England to promote the use of the longbow. In 1595, the army was ordered to replace all bows with muskets. However, archery has remained a popular sport activity in England.

Some of the first archery clubs were formed in England. Competitions were part of their way of life. The English are noted for the three forms of shooting. Butt shooting is where targets are mounted on mounds at 100 to 140 yards. Clout shooting is where targets

are mounted on the ground with a wooden stay in the center. For these two forms, arrows are shot upward to descend on the target. For the third form of shooting, roving archers shoot at simulated small animals over varying ranges on unprepared ground and courses.

Around 1000 A.D., bow and arrow technology swept the Americas. As seen through archeological studies, its use was adopted by most prehistoric native Americans.

In 1879 the National Archery Association was founded. The first national tournament was held in White Stocking Park in Chicago the same year. The first archery club in the United States, the United Bowmen of Philadelphia, was founded in 1928.

In 1900 archery became part of the Olympic games. It was dropped after 1920 because the wide range of rules could not be standardized. In 1931, the Federation Internationale de Tir à l’Arc (FITA) was founded in Paris and standardized the rules for international competition, but it was not until 1972 that archery was again a part of the Olympic program.

## Leadership

Archery must be conducted by trained, qualified on-site Rangemasters who direct the operation of the range program and archery instruction. To qualify as an archery Rangemaster, the Rangemaster must be at least 18 years old and be trained by a National Camping School-trained shooting sports director or a USA Archery/NFAA instructor.

The local council issues a Training Course Pocket Certificate, No. 33767, and keeps a record of those who have been certified. Archery Rangemaster, course code CS 31. Certification must be renewed every two years.

## Training Cub Scouts

The objective is to teach Cub Scouts how to shoot a bow and arrow and to have fun safely.

This instruction is designed for immediate participation and success. For example, beginning archers tend to shoot high because they want to look at the point of their arrows. By placing the bottom of the targets on the ground at 10 yards, rather than at the traditional 48-inch level at 25 yards, fewer arrows miss the target. This means more class time can be spent on shooting and less on looking for arrows.

Before handing out equipment, check each archer’s eye dominance, page 66. Also, look for loose objects on the archers such as pins, pencils, loose sweaters, and watches that could get in the way of shooting.

For the best learning experience, give each Cub Scout a bow, an arm guard, a finger tab, a quiver, and six arrows. If it is not possible for each to have a bow, one bow might be shared by two or more archers.

Caution the class to hold the items but to not shoot until you give exact instructions to do so. Bows should already be strung at the first session. Stringing and unstringing bows may be taught later.

For beginning instruction, have left-handed archers grouped at the right end of the shooting line to allow them a better view of the Rangemaster as they demonstrate.

Instruction takes place at the shooting line. Explain the use of whistles, page 166.

### **Teaching Tips**

The coach-pupil method is effective for all types of skill training and is particularly effective in shooting sports. To put this method into practice:

1. Put the bow in the archer's hand as soon as possible so they can understand the tool while the basics are explained.
2. Group archers into pairs (Scout and parent/guardian would be ideal.) Check for loose items on the bow side of the archer that could interfere with their shooting.
3. The instructor demonstrates the activity or action to be followed before the whole group. When demonstrating techniques, be sure to do them correctly. The instructor then circulates among the pairs, giving a word of advice or assistance, recognizing good work, correcting errors, and determining how well the archers understand the method.
4. Check the archer's finger tab closely before they shoot. Watch for four fingers on the string. Look for cramped fingers on the bowstring. Watch the thumb on the drawing hand. If an archer masters the draw and anchor quite readily, stand behind them and check that when the string is released it will not hit the arm or chest of the archer when they shoot.
5. The archer practices while their partner coaches. Let archers shoot the first arrow as soon as possible, even if the bow hand, anchor, draw, etc., are not perfect.
6. At a predetermined signal, the positions are reversed if using coach/pupil.
7. Progressively, archers are learning by observing, by doing, and by coaching.
8. Use a positive approach. Use praise sincerely. Before making a correction, figure out the fault to find the cause. Never correct a student after spotting a fault on one arrow shot.

9. Avoid long discussions on learning the parts of equipment used. Teach just enough so archers will know how to safely use the equipment.
10. Allow each archer to feel the satisfaction of hitting the target as quickly as possible.

## **Cub Scout Archery Training—Youth**

### **Section I (20 minutes)**

- A. Safety Guidelines, page 66
- B. Equipment, page 69
  1. Review bows, bowstrings, arrows, arm guards, finger tabs, quivers, points of aim, target butts, target faces, and backstops.
  2. Review how to maintain, store, and care for equipment.
  3. Review how to string and unstring a bow. (*Optional*)

### **Section II (40 minutes)**

- A. Archery Shooting Basics, page 66
  1. Eye Dominance, page 66
  2. Stance, page 66
  3. Nock the Arrow, page 67
  4. Establish the Bow Hold, page 67
  5. Draw, page 67
  6. Aim, page 67
  7. Anchor, page 67
  8. Release or Loose, page 67
  9. Follow-Through, page 67
  10. Retrieve Arrows, page 67
- B. Practice, practice, practice

### **Section III (60 minutes) (optional activities)**

- A. The difference between an End and a Round, page 68
- B. Archery Games & Activities, page 68
- C. Cub Scout Awards (Refer to *Cub Scout Shooting Sports Guide*, No. 510-322, in Appendix 20 of this guide)

## **Lion and Tiger Cubs and Archery**

Lion and Tiger Cubs and their adult partners may participate in archery activities. The adult partners must be included in all archery activities. Each Lion and Tiger Cub must be paired with their adult partner before being allowed to shoot.

Keep in mind that youth of this age have very short attention spans (20 to 30 minutes maximum), and tire easily. They probably have little previous experience working as a group and may require more time to understand how the range operates. Lion and Tiger Cubs have a wide range of ability and experience levels, so be ready for anything!

## Safety Guidelines

Lion and Tiger Cubs with their adult partners, Cub Scouts, Webelos Scouts, and AOL Scouts should learn these simple safety rules. When training archers to shoot, be sure to have the proper equipment, secure and safe ranges, and clear safety instruction.

1. Observe all state and local laws on using a bow and arrow.
2. Shoot only with proper range supervision.
3. Always check your equipment before shooting. All defective equipment should immediately be removed from the range.
4. Be sure to include all of the safety guidelines and the proper whistle codes.
5. Bows and arrows should be used only in places set aside for their use.
6. Use only arrows that have been measured for your proper draw length. Arrows that are too short may cause personal injury or damage to the bow and arrow.
7. Always wear an arm guard and finger tab or glove.
8. Keep the arrows in the quiver until everyone is on or behind the shooting line and the Rangemaster has indicated that you may get in proper shooting position.
9. **Archers straddle the shooting line, with one foot on either side.**
10. Always keep your arrows pointed down or toward the target.
11. Only release an arrow when you can see its full clear path to the target.
12. Shoot only at the target in front of you.
13. Stop shooting immediately upon signal from the Rangemaster or if anyone crosses in front of the shooting line or in front of or behind the targets.
14. Always walk, never run, when on the archery range or while carrying arrows.
15. Stay on marked paths. Travel the direction in which the targets are marked.
16. On a target range, leave the bow at the shooting line.
17. Always practice courtesy and good sportsmanship.

### *Know the Proper Whistle Codes*

**Two blasts.** Move up to the shooting line.

**One blast.** Fire the proper number of arrows.

**Three blasts.** Cease firing. Move to the target. Retrieve and score arrows.

**Five or more whistle blasts.** Cease firing. Stay where you are. This is an EMERGENCY. Officials will tell the archers what action to take either verbally or by whistle code.

Remember, there is only ONE command to shoot – ONE blast of the whistle.

For any command of more than one blast, STOP shooting. Watch and listen for further instructions.

## *Sun Safety on the Shooting Range*

The American Academy of Dermatology advises the following protection tips against damaging rays:

- Limit exposure to sun between 10 a.m. and 4 p.m. when the sun's rays are the strongest.
- Generously apply sunscreen with a sun protection factor (SPF) of at least 15 and reapply it every two hours when outdoors, even on cloudy days.
- Wear protective, tightly woven clothing, such as a long-sleeved shirt and pants.
- Wear a hat with a wide, 4-inch brim and sunglasses with UV protective lenses.
- Stay in the shade whenever possible.
- Avoid reflective surfaces, which can reflect up to 85% of the sun's damaging rays.

## **Archery Shooting Basics**

The following instructions are written for right-handed archers. When training left-handed archers, reverse the instructions as necessary.

### *Eye Dominance*

Before shooting a bow, the archers should determine which eye is dominant. Just as people are either right- or left-handed, one eye is more dominant than the other. Discovering which eye an archer favors is important because it could determine on which side the bow should be held.

To find which eye is dominant, have archers extend both arms in front of them and form a small hole with their thumbs and index fingers. Instruct them to look at a distant object through the opening and then pull their hands back to their face. The eye that is in line with the object is dominant.

Assign archers, leaders, and parents in pairs to assist each other, then have them check with the Rangemaster.

***Archers should usually draw back the bowstring with their dominant hand, even if it does not match their dominant eye. If they are cross-dominant, you may suggest they close their dominant eye while shooting.***

### *Stance*

Stance is the correct foot position of the archer. The goal is to provide a solid foundation for the shot. An archer is most stable in an open stance.

1. Stand with feet **straddling** the shooting line.
2. Feet should be about shoulder-width apart.



3. Move the foot closest to the target back about 3 inches.
4. Turn the toes of both feet toward the target about 30 degrees.

### ***Nock The Arrow***

To nock the arrow is to securely place the arrow on the bowstring. When the arrow is securely placed on the bowstring the archer feels and/or hears the arrow “snap” into place.

1. Grasp the arrow below the nock.
2. Bring the arrow up and over the bow and place it on the arrow rest.
3. Spin the arrow so the index vane (usually a different color) points away from the riser (bow) and towards the archer’s body.
4. Push the nock into place on the bowstring directly below the nocking point.

### ***Hook and Grip***

Archers touch the bow in only two places: the bowstring where they “hook” it, and at the grip where they “grip” the bow. *Hook* is when an archer curls three fingers around the bowstring directly beneath the arrow. The *grip* on a bow is where the archer places their hand on the bow.

1. Curl the bowstring with the fingertips of the index, middle, and ring fingers under the arrow.
2. Pull the bowstring back enough to apply a small amount of tension.
3. Center the meaty part of the thumb on the back of the bow grip.
4. Point the thumb toward the target and angle your knuckles 45 degrees. Check to be sure the grip is relaxed.

### ***Raise the Bow***

This step gives the archer the opportunity to confirm that all previous steps have been completed before proceeding. Once that is done, do the following:

1. Turn the head toward the target.
2. Rotate the elbow of the bow arm away from the bowstring.
3. Lift both arms to shoulder height.
4. Extend the bow arm fully, keeping the bow vertical.

The archer raises the bow in preparation for drawing back the bowstring. This gives the archer a sense of direction by knowing where the bow is in relation to the target. While raising the bow, it is important to keep the rest of the body still.

### ***Draw***

Pull the bowstring back toward the face. The draw is seamless and smooth.

### ***Anchor***

The archer should pull the bowstring back to a consistent anchor point every time to maintain accuracy. For beginning archers, the corner of the mouth is the preferred anchor point.

1. Settle the index finger of the draw hand into the corner of the mouth.
2. Keep the draw hand relaxed and against the face.

### ***Hold***

Move the draw arm elbow slightly behind the arrow to brace the draw weight of the bow. The tension of holding the bow is not transferred from the shoulder and arm muscles to the back muscles

### ***Aim***

Aim is lining up the arrow to the target. Simply put, the arrow will go where it is pointed. The goal is to focus equally on the target and the arrow point.

1. Place the point of the arrow on the intended target area.
2. The eye focus is equally on the arrow point and the target.

### ***Release/Follow-Through***

Release occurs when the archer relaxes the tips of the fingers that are hooking the bowstring, allowing the bowstring to push the fingers out of the way. Follow-through is the finish position.

1. Relax the fingertips to allow the bowstring to push the fingers out of the way.
2. Keep the bow arm up.
3. Finish the shot by allowing the draw hand to fall between the ear and the shoulder.

### ***Retrieve Arrows***

After all archers have shot their allotment of arrows (usually around five, if time permits), demonstrate and explain the proper methods to retrieve arrows from the target and ground.

First, before any archer goes to retrieve arrows, permission must be granted by the range officer. The range officer will observe the archers and indicate when all archers have completed shooting and it is safe to retrieve arrows.

1. Follow the proper commands to move to the target line. (*Three whistle blasts.*) Archers should walk slowly to the target line and watch for arrows on the ground.

2. Remove arrows by standing to the side of the target and brace it with the side of the body. Place one hand on the target at the base of the arrow. **(If two people are shooting at the same target, only one should remove their arrows at a time. The other archer should stand back at the target line.)**
3. Grasp the arrow near the target and pull firmly and slowly straight back toward the shooting line.
4. Place the arrow on the ground.
5. Remove the others in the same manner and place them on the ground.
6. After all the arrows have been removed, pick up the arrows from the ground. Cover the points with one hand and grasp the arrows near the fletchings(vanes) with the other hand. If an arrow is buried under the grass, it should be withdrawn by pulling it forward without lifting until it is clear of the grass.
7. Walk back to the shooting line carrying the arrows parallel to the ground with both hands in front of the body. Place the arrows into the quiver, point down.
8. Move off the range, or prepare to resume shooting as commanded.

### Archery Games and Activities

A variety of games or activities can be done using archery skills. Different ranges could be set up to play a particular game, or courses could be set up where archers go from station to station. Archery games and alternate activities work well, especially when archers are in camp for more than one day or if a council sponsors a special archery camp for Cub Scouts.

**Remember, any place there is an archery range and there is archery shooting, even when playing a game or activity, a qualified archery Rangemaster must be present.**

Shooting games are designed to improve shooting skills. Remember, safety is a must.

The following activities and opportunities would be appropriate for Lion and Tiger Cub Scouts with their adult partners, Cub Scouts, Webelos Scouts, and AOL Scouts.

#### *Shooting a Competitive Round*

When shooting a competitive round, an “end” is shooting six arrows at a target. A “round” is the total number of ends to complete the round.

**For example:** An **American round**, in archery, a target-shooting event consisting of **five ends** (six arrows each), shot from distances of 60, 50, and 40 yards

#### *Tic Tac Toe*

Place a Tic-Tac-Toe grid on a target back (You can use flip-chart paper to make the grid or put up nine separate sheets of paper in a 3x3 grid pattern.) Divide the group into two lines, and have them stand in a single file 20 feet from the target. Each team will alternate their archers. Each archer will shoot one arrow and step back. The second and each succeeding archer will shoot one at a time. The first team to get complete a horizontal, vertical, or diagonal row wins.

#### *Wand Shooting*

Place a strip of 1-inch masking tape over the target face from top to bottom. A point is scored when an arrow hits the tape anywhere on the target. Divide the group into two lines, and have them stand in a single file 20 feet from the target. At the signal to shoot, each archer will shoot one arrow and step back. The second and each succeeding archer will shoot one at a time. The first team to get two points is the winning team.

#### *Balloon Bust*

Place a variety of balloons on a target mat. (They may be different sizes and colors.) Divide the group into two lines and have them stand in a single file 20 feet from the target. At the signal to shoot, each archer will shoot one arrow and step back. The second and each succeeding archer will shoot one at a time. The first team to break a set number of balloons is the winning team.

#### *Archery Practice Fun*

Any station set up for participants to practice skills can be fun for Cub Scouts. The archers have limited times to shoot arrows, so the opportunity to practice at a council camp or event is a great experience for them.

#### *Range Layout*

**A sample outdoor archery range layout is included at the end of this section.** Safety is a primary concern when operating an archery range, and the safety rules must be followed.

If at all possible, the range should be laid out so shooting is done in a northerly direction so archers are never facing the sun. To protect arrows, all outcropping rocks should be reduced to ground level. Grass should be planted so a good sod is developed. Keep grass cut close and raked clear. Sandy soils need no ground cover.

Important! Arrange facilities so there is no possibility of non-participants inadvertently walking behind the targets while shooting is in progress!

**Inflatable Ranges** (Only commercially manufactured equipment is allowed to be used.)*(This activity must be supervised by a BSA certified Archery Rangemaster or USA Archery Level 1 or higher instructor.)*



Inspect the string carefully before and after each day's shooting. If any of the strings are broken, discard the string. Check the serving and repair or replace it if it is loose or worn.

Replacement bowstrings should be ordered according to the length and weight of the bow. If a bow is marked 56 inches, 20 pounds, order a 56"-20# string. Do not order by the actual measured length of the string.

### ***Bow Stringer***

Always use a bow stringer to string a recurve bow. The step-through and push-pull methods can cause permanent damage to bows by twisting their limbs. A bow-stringer is a piece of string about 5 feet long that has a leather cap at each end. The larger cap attaches over the bottom bow notch and the smaller cap goes over the upper bow notch. The top cap is small enough for the bowstring to be slipped into the bow notch.

To string a bow, position the bottom end of the bowstring in the bottom notch and slip the caps of the bow-stringer over the ends of the bow. Holding the bow by the grip, allow the stringer to rest on the ground. Step on the center of the bow stringer and smoothly pull upward on the bow grip to tension the bow. Using the thumb and index finger, slide the top loop of the bow-stringer into the upper bow notch.

Check the bow to make sure the bowstring is properly in place. To unstring a bow, tension it and guide the top loop down. Bows that are not in use should be unstrung before being stored.

### ***Arrows***

A shaft made of carbon, aluminum, wood, fiberglass, or composite materials with a point on one end and a nock on the other end. Fletching, which can be either feathers or plastic vanes, are located on the arrow near the nock end.

One way to determine if an arrow is long enough for an archer is to place the nock of the arrow in the center of the chest and hold the shaft with both hands extended in front of them. The point of the arrow should extend at least one inch further than where their hands come together.

**Field point:** Similar to a target point and has a distinct shoulder, so that missed outdoor shots are easier to remove from obstacles such as tree stumps.

**Fletching:** The stabilizing feathers or vanes of an arrow.

**Index fletch or vane:** A different-colored fletch or vane used to indicate proper arrow positioning in relation to the bowstring or bow.

**Nock:** The plastic attachment or grooved notch at the end of an arrow used to attach the arrow to the bowstring.

**Shaft:** The main structural element of an arrow.

**Target point:** Attached to the front end of the arrow and penetrates the target.

### ***Care of Arrows***

Feathers on arrows should be kept dry. If the feathers become wet, wipe them dry and clean before storing. Separate the arrows until they are dry to allow the feathers to expand and regain their original shape. If the feathers are matted down, they can be steamed to return them to their original shape.

Discard any fiberglass or wooden arrows that have splinters or cracks in the shaft.

The arrows can be kept in the quivers during the season, but if they are not going to be used for several months, it is best to store them in the boxes in which they were received. These boxes have individual holes for each arrow. This will preserve the feathers and help prevent wooden arrows from warping.

### ***Arm Guards***

The arm guard is either leather or plastic with at least two elastic straps. It is slipped over the forearm that holds the bow and provides protection from the slap of the bowstring after the arrow is released.

### ***Care of Arm Guards***

Arm guards should have laces or elastic replaced when needed. Arm guards should be kept in labeled boxes. All leather goods will last longer if stored in a cool, dry place and occasionally cleaned with saddle soap.

### ***Finger Tabs***

Finger tabs are preferable to gloves for group instruction because they present fewer fitting problems. Made of smooth leather, finger tabs absorb the friction of the bowstring across the fingertips. Without them, painful blisters can develop. Many designs are available, but for beginners the simplest and most inexpensive type is satisfactory.

***Every Cub Scout archer must use an arm guard and finger tabs.***

### ***Quivers***

For novice shooters, having a quiver to use when returning arrows from the target to the shooting line will improve safety procedures.

## Targets and Scoring

### Target Butts

Targets for beginners should be about 48 inches in diameter and made of straw or Ethafoam. The target butts are placed on soft-pine tripods, about 6 inches off the ground. (Ethafoam is the proper material for a target butt. Plastic foam is messy and does not last long.) Keep the targets close to the ground so missed arrows will not go far and so younger archers can reach the highest arrows easily.

Three to five bales of straw may be stacked to serve as target butts. Make sure the bales are tied back to a post so they will not fall forward on someone pulling arrows. Care should be taken in stacking the bales to be sure they are very close together. Keep the bales off the ground by stacking them on old tires.

### Target Faces

The 48-inch standard target face is recommended for use on outdoor ranges. These are printed on several types of material, including heavy paper, canvas, and oil cloth. If you use paper targets, paste them to light cardboard or they will not last long. Smaller targets are made to be shot at from shorter distances.

The target is made up of five concentric color zones. Each zone is divided by a thin line into two scoring zones of equal width. Each circle represents the following point values:

- Inner gold = 10 points
- Outer gold = 9 points
- Inner red = 8 points
- Outer red = 7 points
- Inner blue = 6 points
- Outer blue = 5 points
- Inner black = 4 points
- Outer black = 3 points
- Inner white = 2 points
- Outer white = 1 point

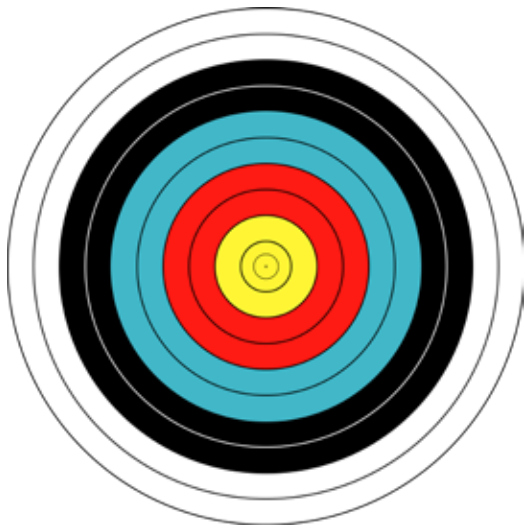

### Care of Target Faces

Target faces should be removed from mats when the mats are being moistened. Masking tape applied to the back of a target face that is tearing from much use will help it last longer. Center patches that cover the gold and part of the red scoring areas on the target face will double the life of the target faces. The patches must be carefully aligned so the lines marking the scoring areas line up exactly.

### Backstops

Baled straw stacked behind the target will catch wild shots. Also, several layers of burlap, old canvas, or rugs hanging loosely over a horizontal pole or plank 1 or 2 inches wide will stop arrows that miss the target. These materials will last much longer if they can be rolled up and stored between seasons.

### Cub Scout Shooting Sports Awards

Cub Scouts earn the shooting sports awards in the following order:

1. **Rank-level patch.** Complete level 1 requirements. This involves participation in archery and acquiring basic knowledge of proper technique, safety, and operations. The patch is only awarded one per program (rank) year.



2. **Discipline device (pin).** Complete the level 2 requirements. This is designed to help a Cub Scout develop and demonstrate further skills, proficiency, and knowledge in archery. These skills are rank specific and provide a progression of skills appropriate for each age and rank of Cub Scouting.

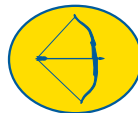



## How To Set Up Outdoor Target Archery Range

Set up for wide-open, cleared space.

### 1. Select the Orientation of the Range

- Avoid shooting into the sun by facing North.
- The ground should be flat and free of obstacles.
- Look for a natural backstop such as a berm to stop arrows. (If there is no berm, provide a minimum of 150 feet of open area behind the targets.)
- The safety zone on the side should be

### 2. Place Range and Safety Lines

- Rope, eco-friendly spray paint or chalk are ways to lay down the range lines outdoors. Follow the guidelines illustrated on the following page.
- Target Line – The purpose of the Target Line is to provide archers a safe place to stand when waiting for their turn to pull arrows from the target.
- Shooting Line – The shooting line is placed close enough to the Target Line to ensure success for the archers to hit the target. This line can be moved back to greater distances as archers become more advanced. The Shooting Line is placed 15-30 feet from the Target Line.
- Waiting Line – Archers stand behind the Waiting Line before and after shooting their arrows. It is meant to act as a safety area between the class and the Shooting Line. The Waiting Line is placed 15 feet behind the Shooting Line.

- OPTIONAL: Controlled Access/Spectator Line – Anyone who wants to watch archers shoot can gather behind this line. This line needs to be placed far enough behind the Waiting Line to prevent distraction from the spectators (at minimum 15 feet)

### 3. Set Up Targets

- Place targets in front of the natural berm. If a natural berm is not available, place targets in a wide-open space with a minimum safety zone of 150 feet behind the targets.
- Evenly space targets in front of the berm. It is best to place the targets five feet, or two arrow lengths, from target-center to target-center. Evenly spaced targets allow for multiple people to shoot at the same target safely.

### 4. Place the Equipment

- Bows – The bow rack is placed between the Waiting Line and the Shooting Line. The bows are placed in the bow rack.
- Ground Quivers – Ground quivers are evenly spaced apart on the Shooting Line. Two quivers per target are suggested.
- Arrows – Place arrows in a central location near the bow rack. Once the instructor is comfortable with an archer's skill level, arrows may be placed in each individual archer's ground quiver.

# Outdoor Range Layout: Wide Open Space

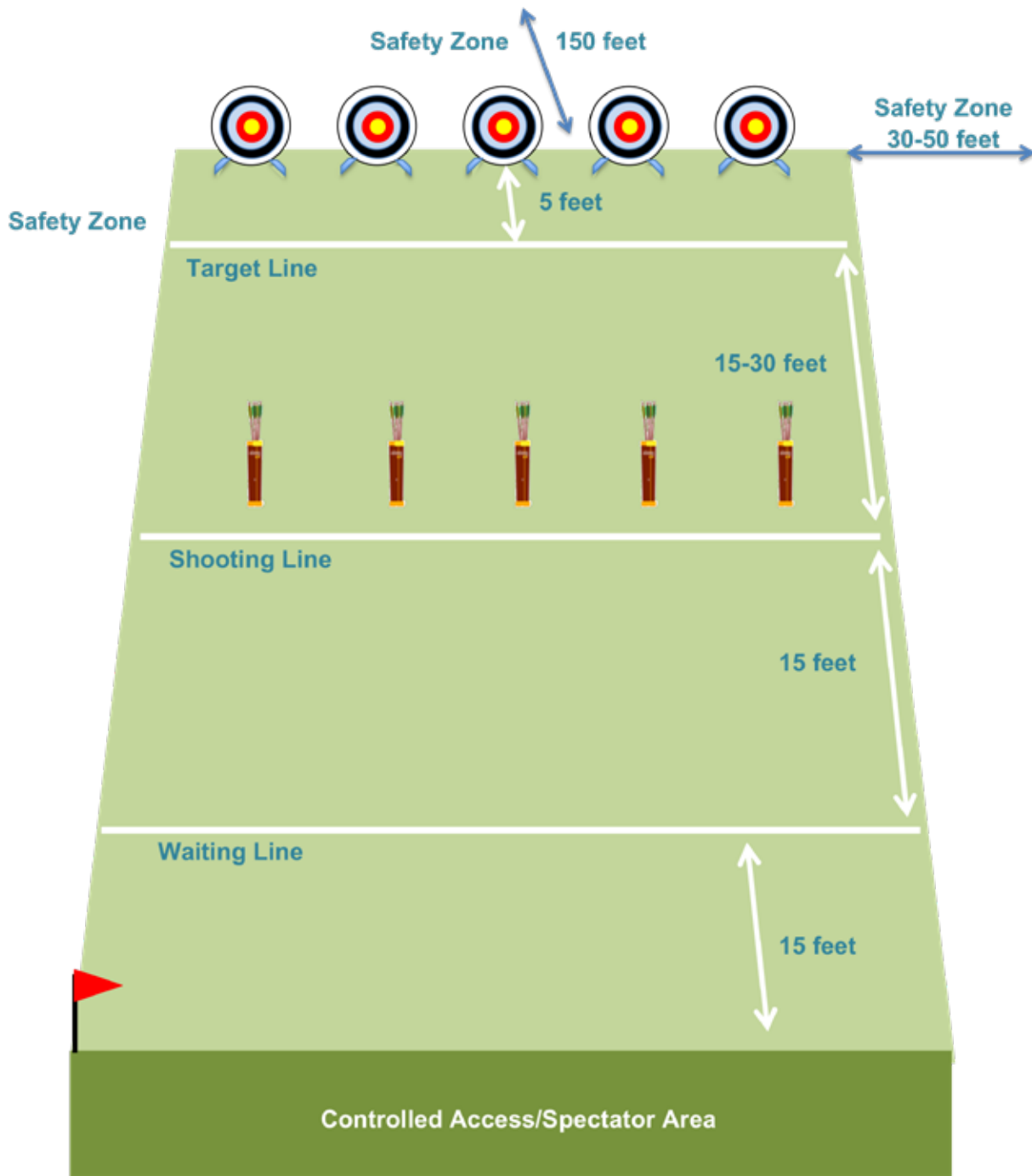

## Directing Shooting Sports in a Council Program

- Know and strictly follow all the safety regulations related to BB guns, slingshots, throwing sports and archery.
- Train staff about safety regulations for all sports areas.
- Train all campers and leaders in the safety fundamentals.
- Check the performance and safety aspects of all areas.
- Restrict from using an area, any person who does not follow all safety instructions.
- Set up all areas in a practical, safe, and inviting manner.
- Always provide qualified supervision for each area.
- Train, schedule, and supervise staff to perform daily routines.
- Check the inventory of all shooting sports equipment. Check equipment to make sure there is enough equipment, and obtain any needed equipment.
- Keep an adequate stock of BB guns, slingshots, throwing sports and archery equipment on hand and be accountable for all inventories.
- Make sure equipment is properly stored and secured appropriately when not in use.
- Organize and promote individual and team competition.
- Report any and all operational and personnel problems to the appropriate staff who may be overseeing the program, camp or activity.
- If appropriate file a closing inventory, a closing report, and recommendations as instructed.

## Safety Instruction Guidelines

To be effective, instruction should use the EDGE method of instruction:

- Explain the safety and safe use of equipment
- Demonstrate proper techniques in equipment usage
- Guide participants in developing skills related to the specific discipline
- Enable participants to meet the goals of the intended program.

Give instruction in simple terms. Controversial methods should be omitted. Make it clear that only one method will be used and that while other methods may exist, there are specific procedures for the current range that must be followed. Instructors should exactly follow the method they teach.

Shooting sports skills must be learned by practice, with each participant learning the rules of safety and self-discipline by putting them into practice. Participants quickly learn that there is no place for foolishness, carelessness, or horseplay when they handle shooting sports equipment. The instructor must

always be mindful of their responsibility to make safety rules thoroughly understood before, during, and after instruction and practice. At the same time, they must have warmth, patience, and understanding for the youth who may not understand an instruction or who finds a skill challenging.

## Positive Aspects of Shooting Sports

From material by R.A. Soldivera, shooting sports consultant

- Shooting sports are part of the Olympic and Paralympic Games.
- Shooting sports do not require participants to start at an early age to be successful. A person may start shooting in high school and compete on a national level before entering college.
- Age does not seem to be a factor in learning shooting sports. Shooting sports have had a national champion who was more than 60 years old, and one as young as 16 years old.
- Shooting sports are for everyone.
- Shooting sports may be conducted both indoors and outdoors.
- Shooting sports may be featured as both a winter sport and a summer sport.
- Shooting sports may offer individual participation, team participation, or both at the same time.
- Shooting sports are recognized as being safe with few injuries.
- Students who have participated in shooting sports report a marked improvement in their ability to concentrate when they apply the principles of these sports to their academic pursuits.
- Sportsmanship has been described as “the quality and conduct of a person who accepts victory and defeat graciously.” Shooting sports has a reputation for high sportsmanship conduct among its participants.
- People with physical disabilities can compete at high levels of competition in shooting sports.
- College scholarships are awarded in shooting sports.



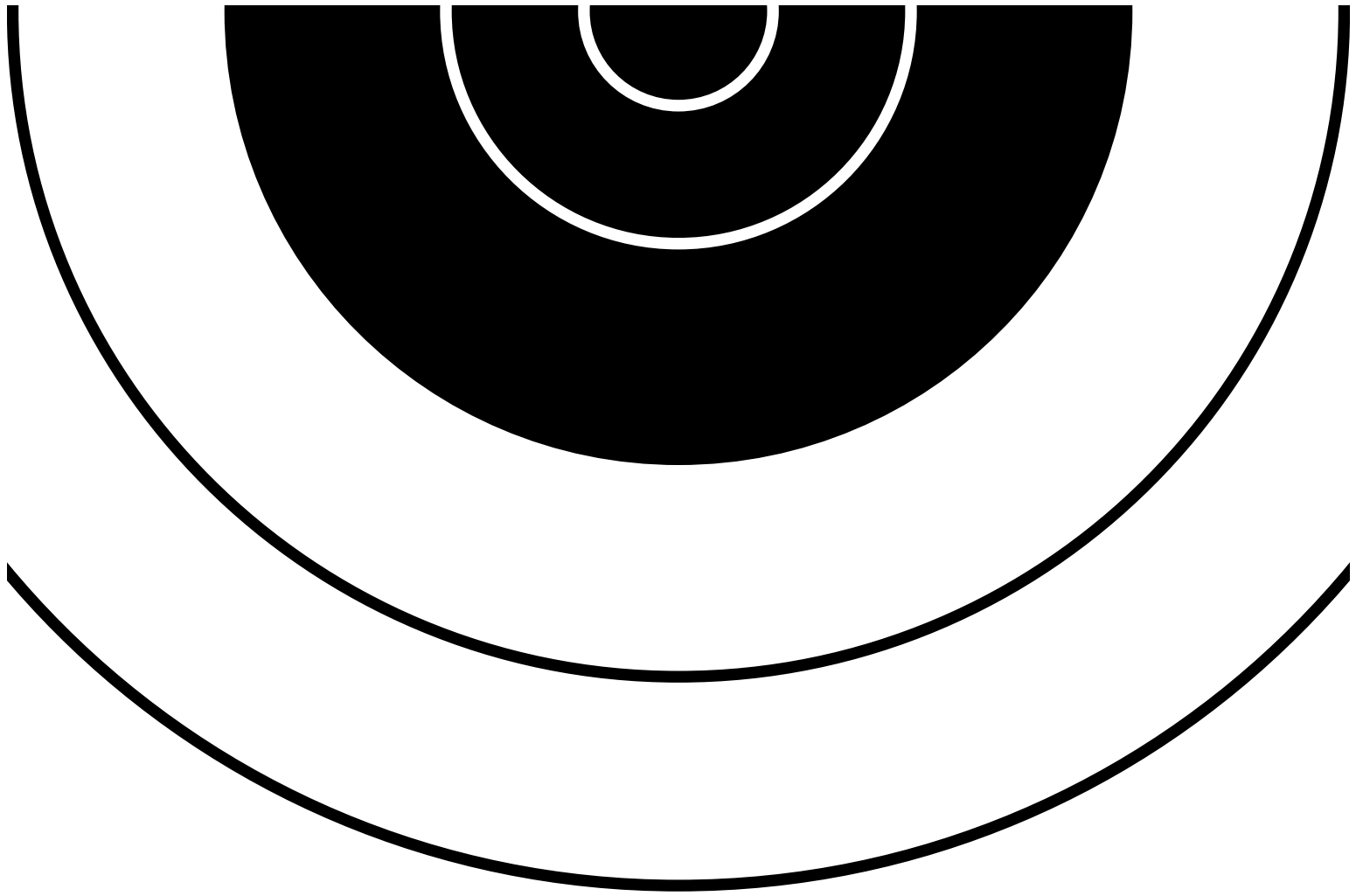

## SECTION VI

# OTHER SHOOTING SPORTS FOR ALL PROGRAM LEVELS

The information in Section VI explains additional shooting-type activities and their related safety concerns. These activities are appropriate for all program levels, from Cub Scouting through Sea Scouting. An extensive resources chapter provides useful information on advancement and recognition and for conducting these activities.



## CHAPTER 10: OTHER SHOOTING SPORTS FOR ALL PROGRAM LEVELS

Many council programs have shooting activities that include slingshots, catapults, balloon launchers, rockets, and some other creative devices. These items are fun and, in most cases, seem harmless. However, any type of shooting activity can be dangerous, and if safety precautions are not taken, accidents can happen easily. Great care should be taken that safety is the key factor for any activity where items are shot through the air.

Before starting any shooting activity adults are expected to follow the SAFE checklist and all activities must fit within the age appropriate guidelines of the BSA.

- Airsoft is not an approved BSA shooting activity for Cub Scouts. It is approved for Scouts BSA, Venturers and Sea Scouts.
- Chalkball/Paintball markers are not approved for Cub Scouts and Webelos Scouts. Scouts BSA, Venturers, and Sea Scouts may only use chalkball/paintball markers to shoot at approved targets—never at another person.
- Marshmallow shooters or blowguns or any device where breath is used to expel the projectile, as well as devices that require a straw or similar device in the mouth are not approved.
- All shooting activities must be approved by the council shooting sports committee or a National Camping School certified shooting sports director.
- The use of catapults or other shooting devices must be approved by the council shooting sports chair or a National Camping School certified shooting sports director and must use appropriate projectiles. (Pumpkins and projectiles larger than a tennis ball are not authorized).
- A safe range must be provided for any activity, such as catapults, that involves shooting objects or water into the air.
- Proper supervision as described in earlier chapters is required for each of these activities.
- See Appendix 8 for a list of additional unauthorized shooting sports activities.

### Shooting on a Safe Range

A safe range must have three things:

1. A safe area
  2. A safe distance
  3. A safe backstop as appropriate for discipline
1. Safe area. Whether inside or outside, be sure the range is set up so no one can accidentally walk in front of the firing line.
  2. Safe distance. Maintain at least 15 feet between the participant and the target.

3. Safe backstop. A backstop designed to keep projectiles from leaving the range. Do not shoot at a hard surface that could cause a ricochet.

### Pellet Guns

**The use of pellet air rifles by Webelos Scouts is restricted to a long-term camp setting and only qualifies when in compliance with the following requirements. Lions, Tigers, and Cub Scouts are not permitted to shoot pellet air rifles.**

- The air rifle pellet gun range meets or exceeds BSA and National Rifle Association recommendations, including nearby latrine facilities, drinking water, first-aid kit, and emergency communications. See Outdoor Programs/Properties design standards on the Web at [www.scouting.org/properties](http://www.scouting.org/properties).
- Air rifles in good repair are provided and must be appropriately sized for participants.
- If any trigger mechanism fails, the air rifle is immediately removed from service. Documentation of the tests is maintained.
- For Webelos all air rifles (CO<sub>2</sub>, pump, break barrel, etc.) are limited to single-shot designated for target shooting, velocity of 500 to 540 feet per second, and energy levels not to exceed 7.5 joules.
- Safe, separate, and locked storage (can be the same building) is provided for pellet rifles, pellets, and CO<sub>2</sub> cylinders and bulk tanks.
- For supervision requirements and shooting experience see charts in Chapter 1.
- A handwashing station (with soap and cold water) is available for all participants to use upon leaving the firing line.
- THERE IS NO EATING OR DRINKING ON THE FIRING LINE.

### Slingshots and Wrist Braced Slingshots

Using slingshots is an affordable, fun activity in camps and many Scouts have not had previous experience with them. Although exciting and fun, slingshots are not toys. Scouts must understand that they must follow the rules when shooting or they will not be allowed to participate.

Shooting items from slingshots and wrist braced slingshots can be dangerous. For these activities, follow the same safety guidelines and rules as used for BB gun shooting. Always shoot at an approved range such as an archery or BB gun shooting range.

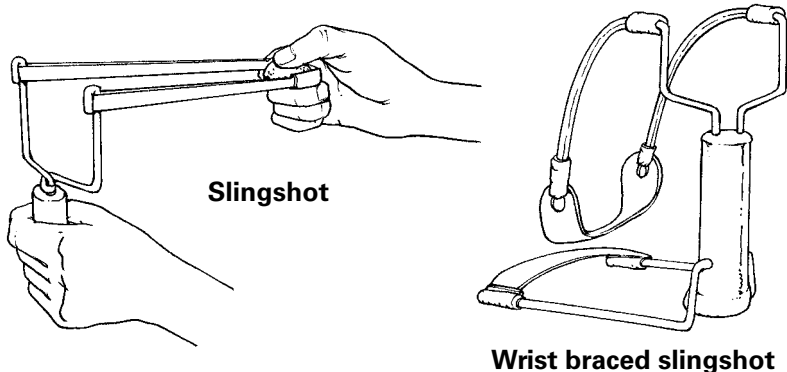

**Slingshot**

**Wrist braced slingshot**

### **Equipment**

Slingshots are usually fork-shaped (Y) and made from very strong and durable wood or aluminum. Broom wood, which is both strong and lightweight and lends itself to carving, is also good for slingshots.

Wrist braced slingshots are a type of slingshot. They are designed to brace against the wrist and therefore seem to be steadier.

Many companies sell excellent slingshots and wrist braced slingshots. Companies that sell BB guns or archery equipment would be good resources for these items. Less expensive slingshots are available in many retail locations. When choosing the slingshot for your camp or activity, consider the experience level of your participants and make sure to obtain devices that are appropriately sized and of good quality.

### **Targets**

Targets for slingshots can be made from a variety of materials, including paper, cans, plastic bottles, and balloons. Paper targets can be homemade or purchased. Cans are excellent as they make a great sound when hit. Cans, plastic bottles, and balloons can be hung from strings or attached to netting. A sample target is shown on page 88. Practice with the slingshot or wrist braced slingshot on a bull's-eye about 2 inches in diameter and with the target 10 feet away, then move the target out to 25 feet.

### **Slingshot ammunition**

- \*Do not use glass, steel, marbles, rocks or any other hard objects that may ricochet.
- \*Paintball/chalkball or clay balls are acceptable (must be approved for the range in use)
- \*Use of small food items while not prohibited may be suitable for younger scouts but may attract unwanted wildlife

### **Slingshot and Wrist braced slingshot Guidelines**

(Instructions are for right eye dominant participants. Reverse instructions for left eye dominant participants where applicable.)

1. A certified BB Rangemaster must be present on the range and oversee the program.
2. A 1-to-1 adult-to-participant ratio must be used for Cub Scout level shooting and a 1:4 adult to participant ratio must be used for all other levels in Scouting.
3. Use a safe shooting range such as a BB gun range or archery range.
4. Properly sized protective eyeglasses or goggles must be worn by participants, adult helpers and rangemaster.
5. Participants must only pick up devices when instructed to do so.
6. Participants must only shoot when instructed and have a clear view of the target and what is beyond it.
7. If a slingshot becomes damaged during use or appears to be worn, this slingshot must be taken off the line and repaired or replaced.
8. Slingshots must only be aimed downrange in a safe direction and not into the air.
9. Participants must stay behind the firing line while shooting is taking place.
10. Participants should point their left foot and shoulder directly at the target with the body turned to the right and turn their head directly toward the target.
11. Center the ammo in the middle of the pouch. Hold the handle firmly in the left hand and pinch the ends of the pouch together with the thumb and index finger of the right hand, encompassing the ammo.
12. Hold the left arm out straight and firm. Draw the right hand back level with right cheek—NEVER TO THE EYE—while holding the pouch securely between the thumb and index finger of the right hand.
13. Aim and release the ammo pouch to shoot.
14. Always practice courtesy and good sportsmanship!

## Catapults and Other Shooting Devices

Catapult activities table top size used for STEM or den activities or pioneering projects less than 5 feet in height are the only approved apparatus. NOTE: contests where the object is to shoot a projectile for great distance are not approved. The potential energy for the catapult should be restricted as appropriate.

Catapults using hydraulic, gas, springs, counterweights, or any other gravity propelled device to provide the propulsion are prohibited. Care should also be taken when determining the number or use of rubber band or bungee cords.

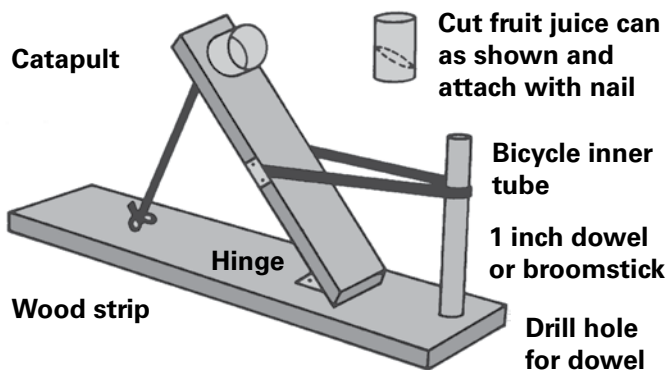

**Table top example above (den meetings/STEM activity)**

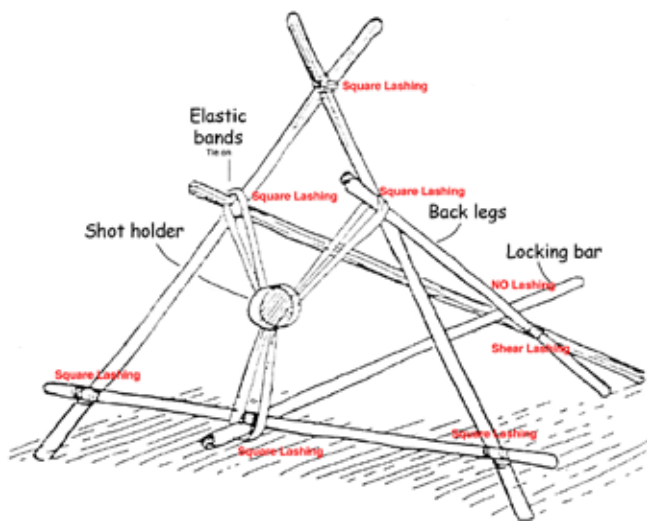

**Catapult shown above made with BSA Scout hiking staff.**

### Ammunition

Water balloons - use small, biodegradable balloons, and fill them no larger than a ping pong ball. Note: When using balloons be sensitive to latex allergies that may be present.

Soft objects - no larger than the opening of a small juice can.

Only soft objects are approved.

The use of any projectile larger than a tennis ball is not approved.

Although specific rules have not been written about each type of shooting activity, these general guidelines apply:

1. Have fun and be responsible!
2. Always wear eye protection.
3. Do not aim any shooting device at a person. Never shoot any projectile, even if it is soft or seems to be harmless, at or near people, animals, or personal property. This includes water balloons.
4. A balloon launcher is not a toy and is made for the sole purpose of launching water balloons. Never launch water balloons at eye level.
5. Do not use any projectiles such as rocks, pebbles, or ball bearings that are hard or that could cause harm.
6. Never use a launcher if there are signs of wear. Check before each use.
7. When using a slingshot or balloon launcher, never put your finger or hand between the tubing connection and the handle.
8. Targets may be made similar to those for archery and BB gun shooting. Creative targets may also be made that relate to the camp theme.
9. The catapults must be launched on range which meets the criteria of a safe range: safe area, safe distance, and safe backstop as appropriate for the size.
10. The range must be established. This can be a temporary area appropriately sized for the activity. Make certain that no one will wander into the landing zone of the projectiles.

### Flash Ball

Flash Ball is a shooting sport for shotgun shooting based on clay pigeon shooting and offers a whole new experience. The throwers used can be easily adjusted to fire a number of varied trajectories. Adding a wider range of targets by using more than one machine makes this already addictive game even more challenging. Targets are filled with white non-toxic powder. When the player hits the target, it flashes, producing the same effect as the flash clays used at the Olympics and other major shooting events.

These programs are BSA-approved for use by Scouts BSA, Venturers, and Sea Scouts. Supervision for this activity must follow the guidelines for shotgun shooting.

### Sporting Arrows

These programs are only approved to be conducted at the council or district level camp and must follow the program outline in the appendix 22. They require a range layout that is larger in size than a standard archery range, as well as an initial financial investment to secure the needed equipment. The traps are stand-alone machines, and the targets are reusable.

To conduct these programs, the council needs to

complete an application and submit it for approval to the Outdoor Programs/Properties department. This application can be found at <https://www.scouting.org/outdoor-programs/shooting-sports/> The range layouts, standard operating procedures, and qualified supervision requirements are available at <https://www.scouting.org/outdoor-programs/properties/resources/design-guide-lines/>. Completed applications can be emailed to [shootingsports@scouting.org](mailto:shootingsports@scouting.org)

## Tomahawk Throwing

This is a program for Scouts BSA, Venturers, and Sea Scouts. This program is not approved for Cub Scouts or Webelos Scouts.

### Overview

The purpose of this document is to give an overview of the sport of tomahawk throwing and how it can be adapted to age-appropriate levels for Scouting.

**The Sport of Tomahawk Throwing.** Tomahawk throwing is increasing in popularity in America. Today, hand-forged tomahawks are made by craftsmen throughout the United States.

**Proper equipment selection and range setup.** A variety of styles and sizes of tomahawks are available today from several manufacturers. Most craftsmen say that heads will last over a decade when properly cared for, and most favor handles made of hickory. Popular tomahawk styles include:

- French or Blackhawk—With handles about 18 inches long, and heads weighing from 12 to 24 ounces, this style of tomahawk is appropriate for all ages.
- A kiddy 'hawk or junior Blackhawk—A good choice for young Scouts, this style measures about 10 to 14 inches long, and its head usually weighs about 8 to 12 ounces.



**Target Styles.** Targets can be made in a variety of styles and from many materials. Following are some suitable options.

- Hay bales—These targets are the cheapest to make and easiest to use. Stack three to make a wall, and attach a paper or painted target.
- Soft wood posts—Logs of pine or other soft wood or repurposed telephone poles make great targets. Dig a 24-inch deep hole, and bury the end so it is stable.
- A-frame stands—Stands can be made from 2 x 4s with ends cut at a 45-degree angle and attached like a tripod at the back. Attach a cross-brace to support the weight of the target. The best target rounds are made of palm trees, and are a minimum of 12 inches in diameter and cut 8 to 10 inches thick. Attach them to the back of the stand using heavy screws.
- H-frame stands or backboard stands—These 2 x 4 frame stands are made of plywood and hardtack to stand up to wear and tear. They can be stabilized or installed permanently by staking them to the ground.
- Target wall—Sink two 2 x 12 posts for each target, and install multiple targets or stations for group activities.



**Range setup.** All ranges must have adequate space and provide participants a clear line of sight. Each range must have a clearly marked perimeter with signage that alerts bystanders of potential shooting sports danger. The range must have sufficient buffers all around, with 15 to 25 feet on each side and 25 to 50 feet at the rear of the range.

Access to the range should be restricted with a clearly marked gate. The range should have a staging area where safety information and instructions can be shared. Throwing and safety lines should be clearly marked and a minimum of 5 feet from each other. Safety stands or a stack of target rounds on the throwing line can help designate safe observation areas. Each lane should be 5 feet wide to accommodate sufficient throwing space. The distance from the target face to



the throwing line is generally 15 feet, but it can be reduced to 10 feet for younger Scouts. Care should be taken to placethrowers of similar height in lanes beside each other so that a minimum target distance can be achieved with one youth in their throwing lane is not in front of another.

Minimum 6 feet between the throwing line and safety line behind the thrower must be maintained.

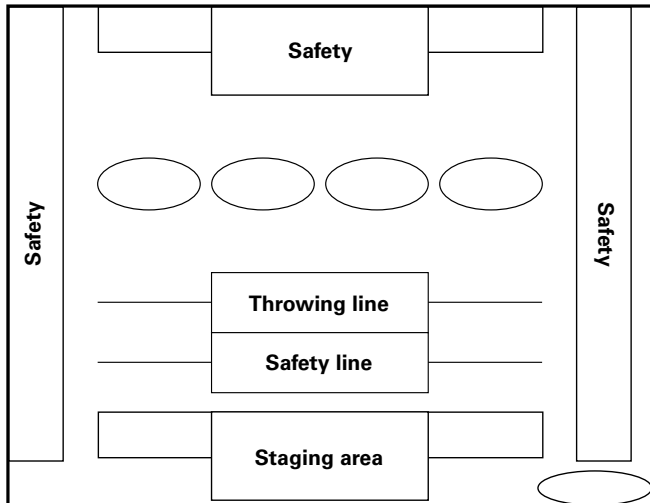

Another option is the multi-target range with the participants in the center facing out and targets set around the perimeter:

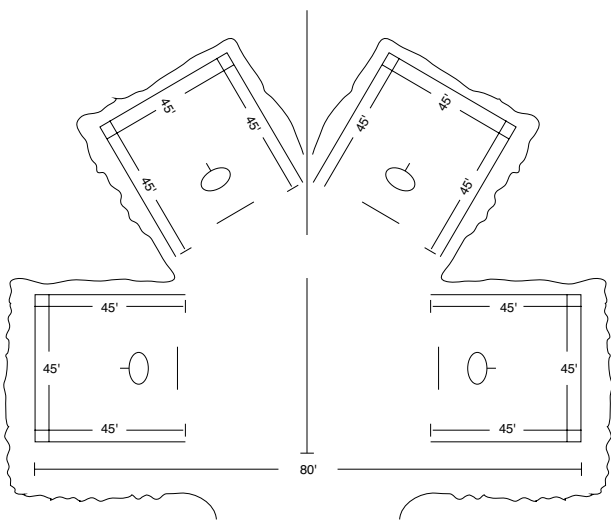

### Range Supervision: Operating the Tomahawk Range

#### Review Range Safety Rules

- Wear hard-toed shoes while on the rangewhenver possible.
- Move to the throwing line when directed to.
- Participants should check the backstop prior to throwing
- Begin throwing when given the command by the range supervisor.
- Only move forward to retrieve hawks when given the command from the range supervisor.

### Sample range commands

#### Range commands

ii) Range commands are to be spoken clearly, loudly, and in the direction of the participants. All participants are to be given a review of the range commands to be used before any throwing can begin.

The following are the basic range commands.

#### 1. Commence Throwing

Gives permission to the group to start throwing

#### 2. Cease Throwing

Tells all participants to stop throwing immediately

#### 3. Range Open

Declares that the range is considered safe to proceed to throwing stage, but does not give permission to throw.

#### 4. Range Closed

Declares the range is closed for throwing. All throwing must cease. This command may be given with or without a preceding or following Cease Throwing command. It is recommended that Cease Throwing command be given in conjunction with the Range Closed command whenever possible.

#### 5. Retrieve your tomahawks

Tells all participants that they may retrieve their tomahawks from the target area. This command must be coordinated with adjacent ranges to ensure that one group is not throwing while another is retrieving.

#### 6. Exit Range

Tells all participants to exit the range

**Stances.** (Described for right-handed throwers; reverse for lefties.)

- Side-by-side stance ( 2 handed throwing - This stance is the safest.)
  - Feet evenly squared with the target
  - Left hand on bottom of handle
  - Right hand on top of left with thumb facing up (helps with rotation)
- Sideways (One handed throwing. This stance is optional; ensure that the draw goes directly overhead and not to the side, which causes the tomahawk to turn.)
  - Body and feet 90 degrees from the target on dominant side
  - Right hand on bottom of handle with thumb facing up
  - Aiming. Site the target with arm extended and tip of 'hawk pointed to desired spot.

## **Throwing**

- Keep elbows and wrists locked.
- Draw tomahawk back over top of head.
- Bring it forward until initial aiming point is reached.
- Release the tomahawk.
- Repeat this process for each 'hawk in the round.

## **Retrieval.**

- Only when the Range Safety Officer allows, walk to the target—do not run.
- Proper technique to remove tomahawks:
  - Place one hand on the target above the handle, and with the other, firmly grasp the handle of the tomahawk.
  - Push down on the handle, and then pull up on the handle.
  - The tomahawk will release from the target.
- General safety during 'hawk removal:
  - Always remove the 'hawk above your head first, and drop it to the ground.
  - If you should stick more than one 'hawk, keep one hand on each during removal from target.
- Once all 'hawks have been removed, pick them up, and grasp the head of the 'hawk in the palm of the hand with blades facing away from the body. (similar to carrying a hand axe)
- Return the 'hawks to the throwing line with the blades facing downrange.

## **Sticking the Tomahawk**

The key to sticking is consistency, which is most easily attained with a tomahawk of sufficient size and weight. Throw the heaviest tomahawk possible without causing strain. For most people, a head weight of about 16 ounces works well.

Common throwing adjustments that can be made.

A “good stick” is when the handle is about 45 degrees in relation to the surface of the block target. This would appear like the upper corner of the blade forming an acute angle with the top of the head. When this takes place the tomahawk will penetrate deeper and is less likely to fall out.

If the 'hawk is over rotating or under rotating when thrown the handle will make contact with the target with the 'hawk handle above or below the 'hawk head. To correct when this happens the thrower could take a small step forward or back before throwing.

## **Equipment Repair: Replacing Handles and Heads**

If you throw tomahawks, eventually you break handles. As skill improves, breakage occurs less often. Tomahawk replacement handles should meet the manufacturer guidelines of your 'hawk and must be the correct size and shape for the 'hawk you are using. For

information about replacement handles see your owner information for your 'hawk.

Sharpening your tomahawk should be done with a file; using a sharpening stone is advisable but optional. Refer to your owner's information or the Scouts BSA Handbook as the process is similar to sharpening an ax.

## **Sample Tomahawk Competition Rules**

From the International Knife Throwers Hall of Fame (IKTHOF)

### **For a four-round competition**

#### **Youth ages 16 and over**

Throwers compete in four rounds of three tomahawks from each of five distances, for a total of 60 tomahawks.

Each round consists of 15 tomahawks, three thrown from each distance:

- Three at one spin at a minimum distance of 10 feet
- Three at one and a half spins from a minimum distance of 13 feet
- Three at two spins from a minimum distance of 19.5 feet
- Three at two and a half spins from a minimum distance of 23 feet
- Three at three spins from a minimum distance of 29.5 feet

Maximum 300 points

#### **Youth ages 11–15**

Youth follow the same throwing progressions as adults, but with no minimum distance.

Maximum 300 points

## **Knife Throwing**

This program is for Scouts, BSA members, Venturers, and Sea Scouts. This program is not approved for Cub Scouts or Webelos Scouts.

## **Overview**

The purpose of this document is to give an overview of the sport of knife throwing and how it can be adapted to age-appropriate levels of Scouting.

The following information will help you comply with the standards:

- Proper equipment selection and range setup
- Standard operational procedures (age-appropriate instruction and training)



## **Proper equipment selection and range setup**

### **Getting the right knife**

Whichever knife you choose, it needs to have certain qualities. Keep the following factors in mind:

- A sharp point (The knife's blade should be dull for safety.)
- Standard thick enough so it will not bend when it lands
- A solid blade to ensure it doesn't break
- Rounded corners
- Handles without excessive ornamentation
- At least 8 inches to a foot in length
- Only knives manufactured for the purpose of throwing are authorized.

**Target Styles.** Targets can be made in a variety of styles and from many materials. Following are some suitable options:

- A-frame stands – Stands can be made from 2x4s with ends cut at 45 degree angle and attached like a tripod to the back. Attach a cross-brace to support the weight of the target.
- H-frame stands or backboard stands – These stands are made of plywood or other similar material to stand up to wear and tear. They can be stabilized or installed permanently by stacking them to the ground.
- Target wall – Sink two 2x12 posts for each target.
- Targets can be a thick piece of pine or other soft wood attached to the frame. The wood should be mounted so the grain is going in a vertical direction. This makes it easier for the knife to stick in the wood.
- Another option for the target is to cut a 18"x18" board and attach layers of cardboard to it with tuck tape. As the target is cut up, you can place additional layers of cardboard over the original.
- **DO NOT TARGET TREES**

**Range setup.** Follow the same setup as listed for tomahawk throwing.

### **Range supervisor: Running the Knife Throwing**

#### **Review Range Safety Rules**

- Wear hard-toed shoes while on the range whenever possible.
- Move to the throwing line when directed to.
- Participants should check the backstop prior to throwing.
- Begin throwing when given the command by the range supervisor.
- Only move forward to retrieve knives when given the command from the range supervisor.

## **How to throw a knife**

**Stance (Described for right-handed throwers; reverse for left handed throwers.)**

- Stand up straight and stay relaxed.
- Keep your right foot forward with the left foot slightly behind it.

### **Grip**

- Grip knives from the handle end.
- **Hammer Grip (1)** – is best for beginners
- **Pinch Grip (2)** – (Commonly used with lighter knives.) Pinch the handle between the thumb and index finger. (An option is to use two or three fingers opposite the thumb.)

### **Throw**

- Grasp the knife.
- Bend your elbow at a 90 degree angle and hold your arm in front of you.
- Move your hand back and up, keeping your eyes on your target.
- When you are comfortable, quickly swing your arm forward and release the knife directly at the target.

### **Retrieval**

- Only when the range supervisor allows, walk to the target – do not run.
- Place one hand on the target, and with the other, firmly grasp the handle of the knife
- Push down on the handle and lift up. The knife should release from the target.

## **Sample range commands**

### **Range commands**

ii) Range commands are to be spoken clearly, loudly, and in the direction of the participants. All participants are to be given a review of the range commands to be used before any throwing can begin.

The following are the basic range commands.

#### **1. Commence Throwing**

Gives permission to the group to start throwing

#### **2. Cease Throwing**

Tells all participants to stop throwing immediately

#### **3. Range Open**

Declares that the range is considered safe to proceed to throwing stage, but does not give permission to throw.

#### **4. Range Closed**

Declares the range is closed for throwing. All throwing must cease. This command may be given with or without a preceding or following Cease

Throwing command. It is recommended that Cease Throwing command be given in conjunction with the Range Closed command whenever possible.

**5. Retrieve your knives**

Tells all participants that they may retrieve their knives from the target area. This command must be coordinated with adjacent ranges to ensure that one group is not throwing while another is retrieving.

**6. Exit Range**

Tells all participants to exit the range

## CHAPTER 11: RESOURCES, CERTIFICATES, AND PATCHES

### Resources

Archery Trade Association  
P.O. Box 70  
New Ulm, MN 56073  
866-266-2776  
[www.archerytrade.org](http://www.archerytrade.org)

National Field Archery Association (NFAA)  
800 Archery Lane  
Yankton, SD 57078  
605-260-9279  
[www.nfaa-archery.org](http://www.nfaa-archery.org)

USA Archery  
210 USA Cycling Point, Suite 130  
Colorado Springs, CO 80919  
719-866-4576  
[www.USArchery.org](http://www.USArchery.org)

Daisy Manufacturing Company  
P.O. Box 220  
Rogers, AR 72757-0220  
479-636-1200  
[www.daisy.com](http://www.daisy.com)

Marksman Products  
10652 Bloomfield Ave.  
Santa Fe Springs, CA 90670  
800-822-8005  
[www.marksman.com](http://www.marksman.com)

Crosman Corporation  
7629 Routes 5 and 20  
Bloomfield, NY 14469  
800-724-7486  
[www.crosman.com](http://www.crosman.com)

National Rifle Association (NRA)  
11250 Waples Mill Road  
Fairfax, VA 22030  
800-672-3888  
[www.nra.org](http://www.nra.org)

Tread Lightly!  
800-966-9900  
[www.respectedaccess.org](http://www.respectedaccess.org)

*Webelos Handbook*, No. 33452  
Boy Scouts of America



### Sample Archery Scorecard

These cards may be reproduced for campers in the archery program to keep their score as they strive to improve their shooting skill.

Arrow Score			Hits	End Score	Running Score
Total					

Signature

Arrow Score			Hits	End Score	Running Score
Total					

Signature

Arrow Score			Hits	End Score	Running Score
Total					

Signature

Arrow Score			Hits	End Score	Running Score
Total					

Signature

Sample Targets

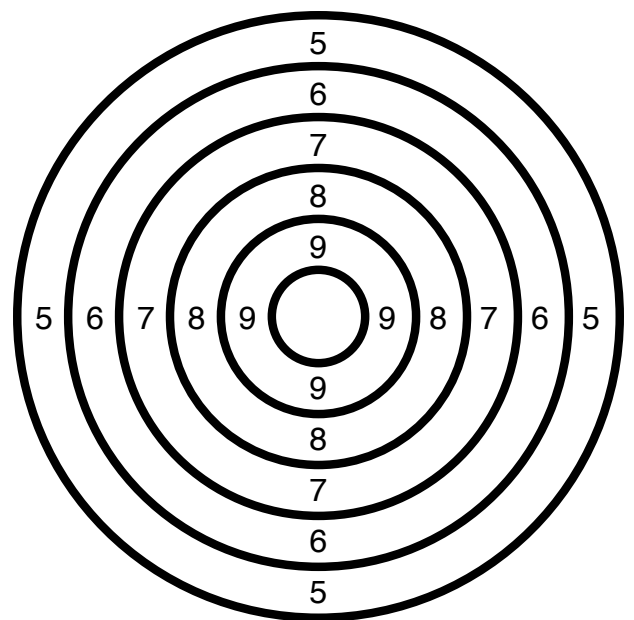
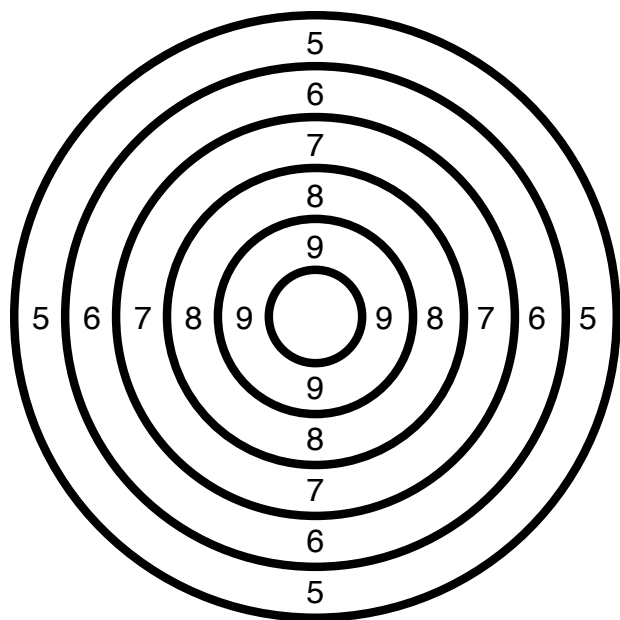
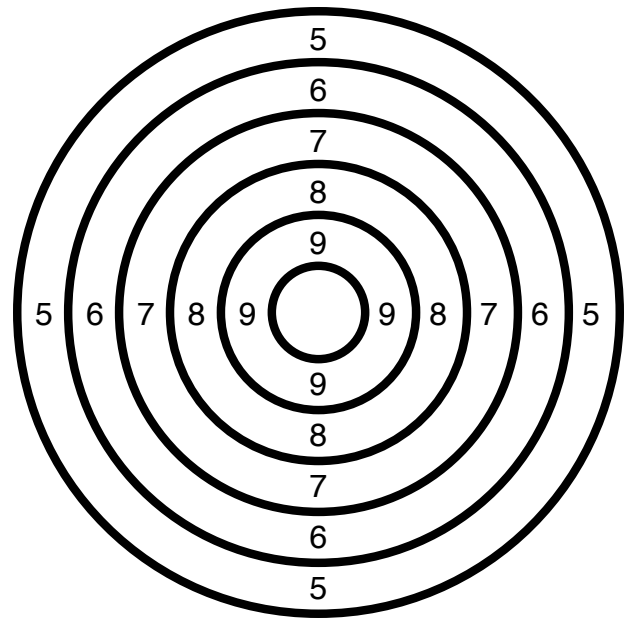
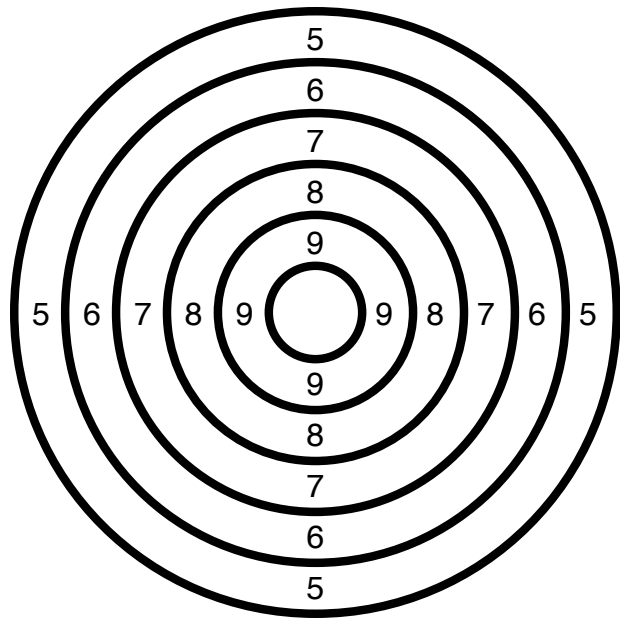

## Crossword Puzzle: Air Gun Shooting

So you think you know a lot about air gunning? Here's a crossword puzzle to test your knowledge of air guns, ammunition, and common shooting terms.

If you find yourself stumped, you can check the answers below.

1. You shoot at this.
2. Your point total.
3. The diameter of a bore determines this.
4. An air gun has none. Kick.
5. Soft lead air gun projectile.
6. Olympic participants strive for this.
7. The inside of the barrel.
8. You catch pellets, BBs, and mice in one of these.

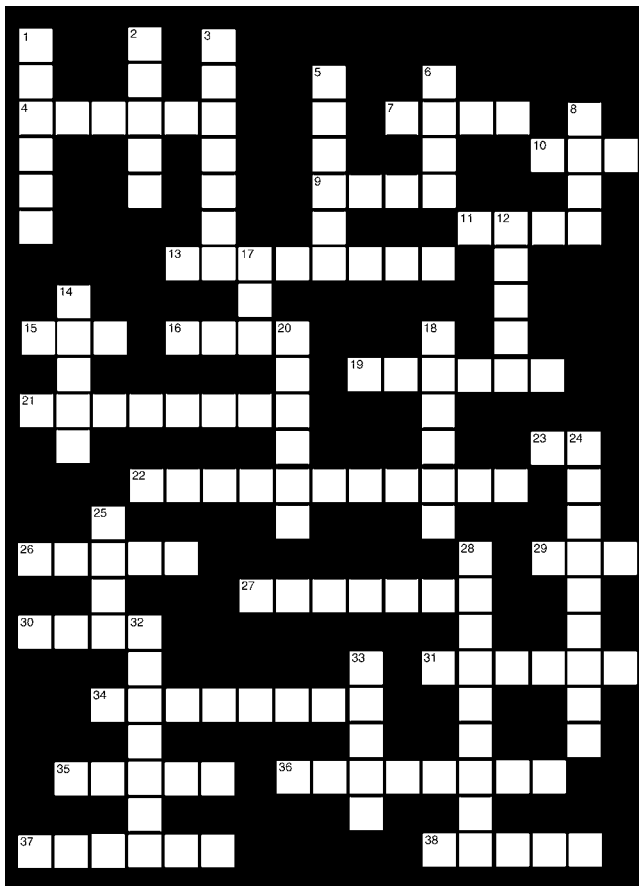

9. You do this when you put pellets or BBs in an air gun's receiver.
10. National Rifle Association.
11. The part by which you hold a pistol.
12. The place where you shoot.
13. Lots of this will make you a better shooter.
14. You hold this type of air gun against your shoulder.
15. The opposite of a miss.
16. A pneumatic air gun requires you to do this to increase air pressure.
17. You do this when you line up the sights on a target.
18. Every shooter's primary responsibility.
19. Handle every gun as if it were this.
20. A hand-held air gun.
21. The highest level of international air gun competition. It takes place every four years.
22. The metal targets that are profiles of rams, turkeys, pigs, and chickens. Use only pellets to shoot them.
23. A perfectly round, copper-covered steel ball fired from some air guns.
24. A new sport that combines the challenges of air gunning and off-road bicycling.
25. This opens a rifle's action.
26. The position air gunners take lying down.
27. The world leader in air gun technology.  
A bikathlon sponsor.
28. This type of air gun is powered by a pump system similar to a bicycle pump.
29. The largest silhouette target.
30. This part of the rifle goes against your shoulder.
31. Always point this in a safe direction. The end of a barrel.
32. Squeeze this to make an air gun fire.
33. The grip, comb, and butt are on this part of a rifle.
34. Never shoot BBs at metallic silhouette targets because they might do this.
35. The aiming device on an air gun.
36. The most important component of an air gun range.
37. The projectile travels from the receiver to the muzzle through this.
38. A telescopic sight.

### Crossword Puzzle Answers

- |            |              |                 |               |              |
|------------|--------------|-----------------|---------------|--------------|
| 1. Target  | 9. Load      | 17. Aim         | 25. Bolt      | 33. Stock    |
| 2. Score   | 10. NRA      | 18. Safety      | 26. Prone     | 34. Ricochet |
| 3. Caliber | 11. Grip     | 19. Loaded      | 27. Crosman   | 35. Sight    |
| 4. Recoil  | 12. Range    | 20. Pistol      | 28. Pneumatic | 36. Backstop |
| 5. Pellet  | 13. Practice | 21. Olympics    | 29. Ram       | 37. Barrel   |
| 6. Gold    | 14. Rifle    | 22. Silhouettes | 30. Butt      | 38. Scope    |
| 7. Bore    | 15. Hit      | 23. BB          | 31. Muzzle    |              |
| 8. Trap    | 16. Pump     | 24. Bikathlon   | 32. Trigger   |              |

# Quiver and Bow Rack

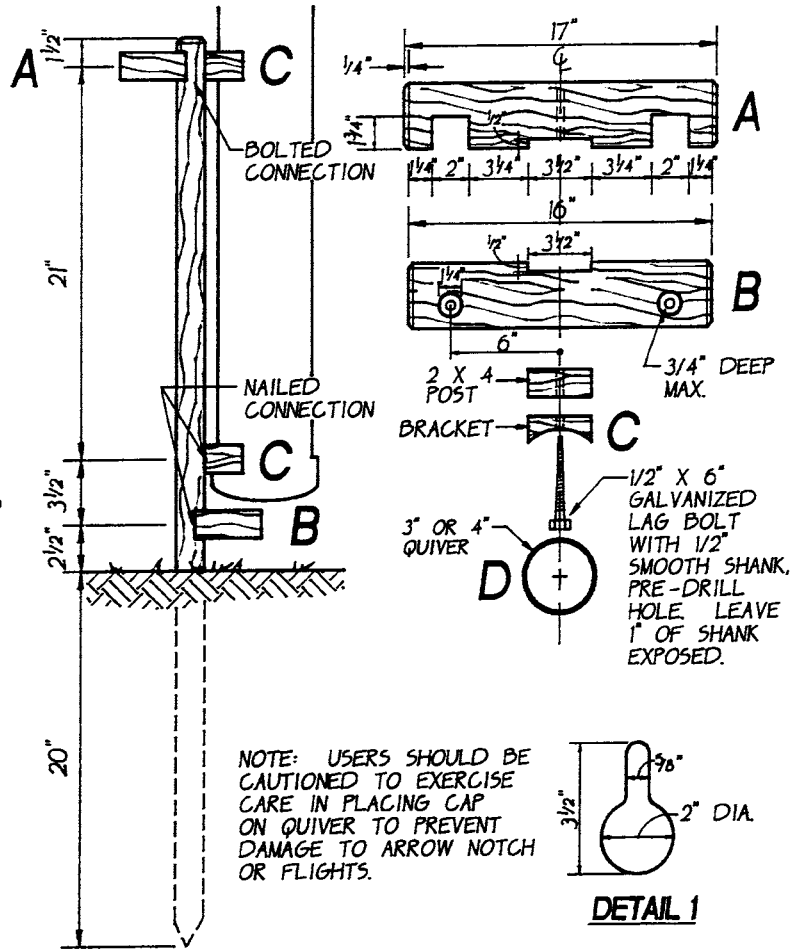
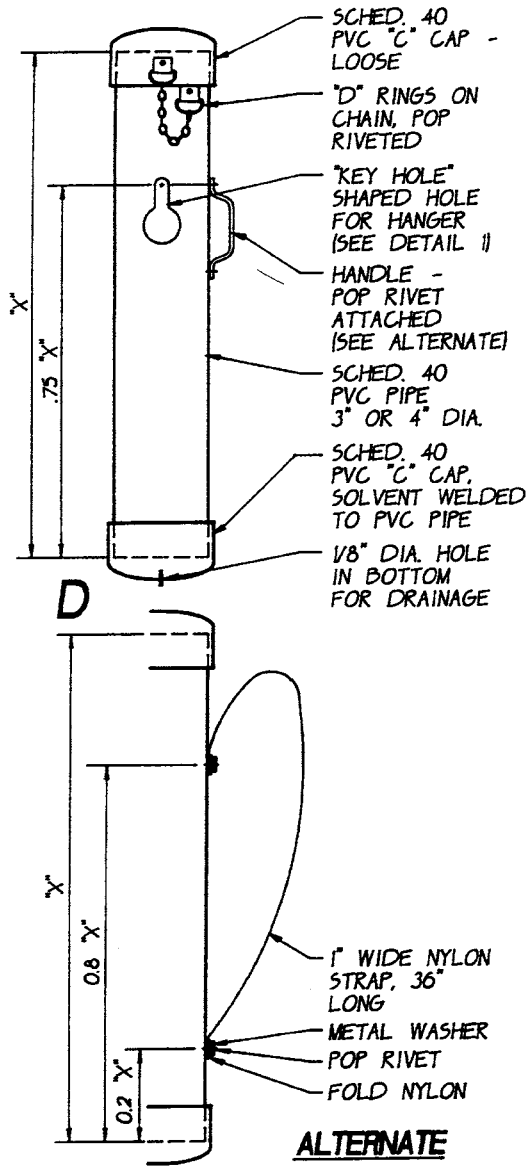

NOTE:  
 X = 27" FOR 26" LONG ARROW  
 X = 29" FOR 28" LONG ARROW



## Archery Storage Locker

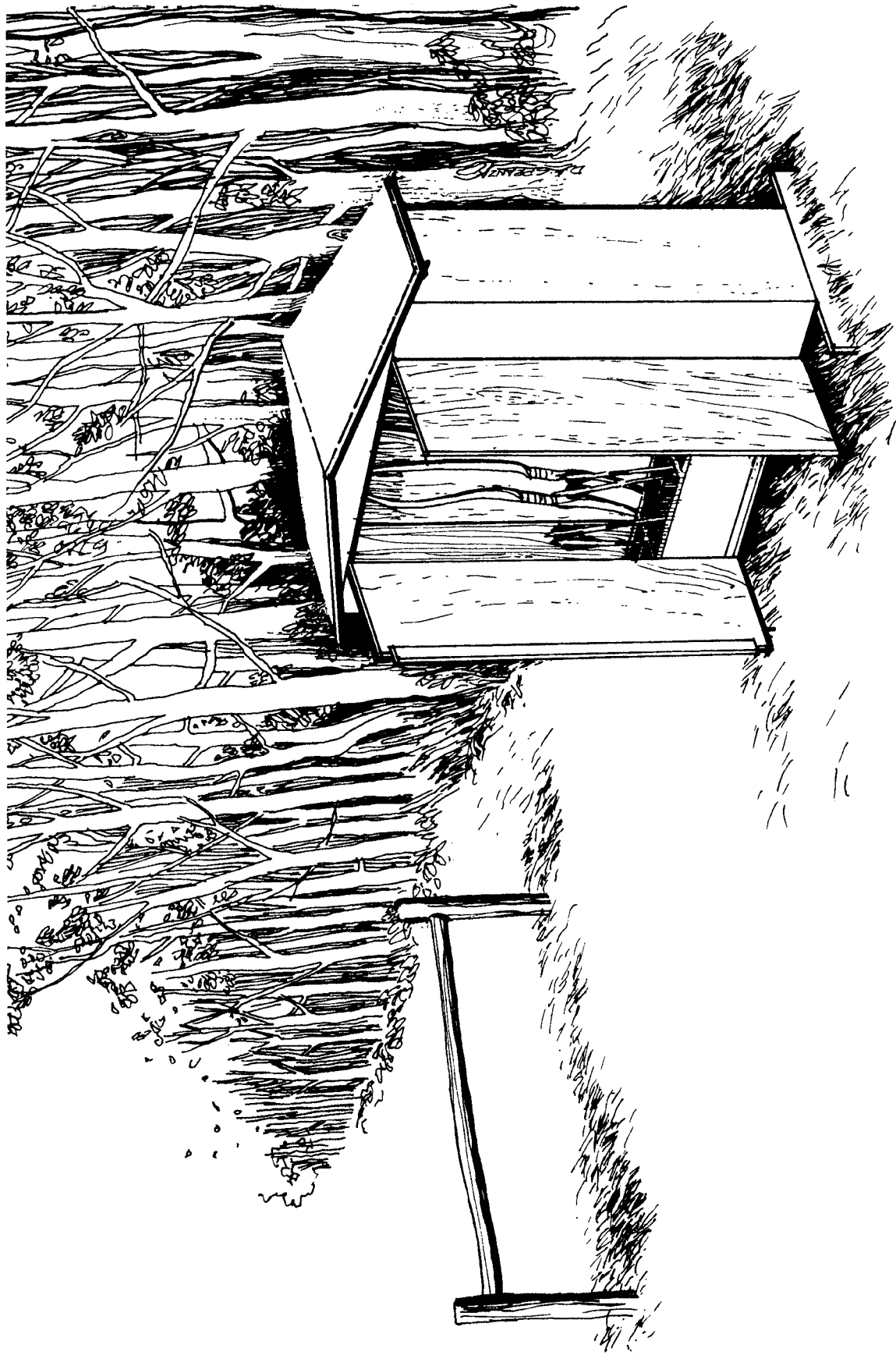

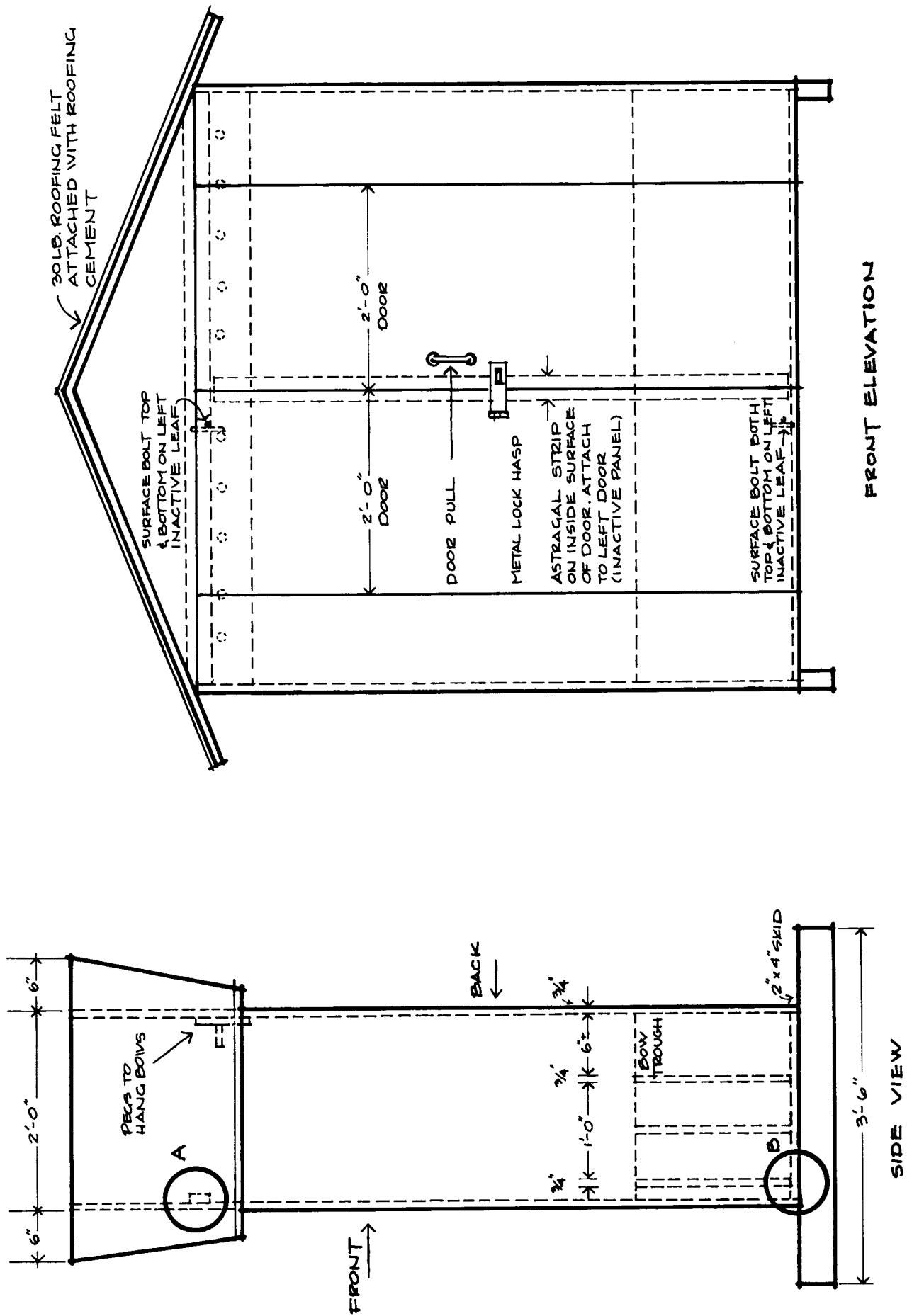

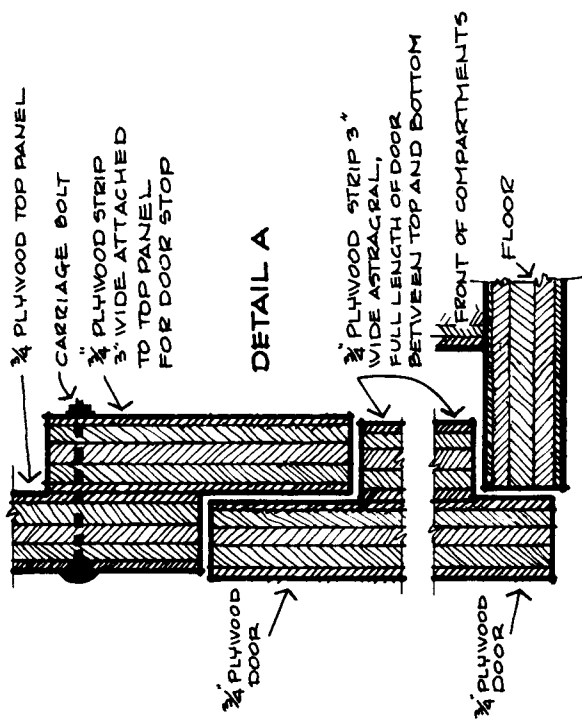

**DETAIL B**

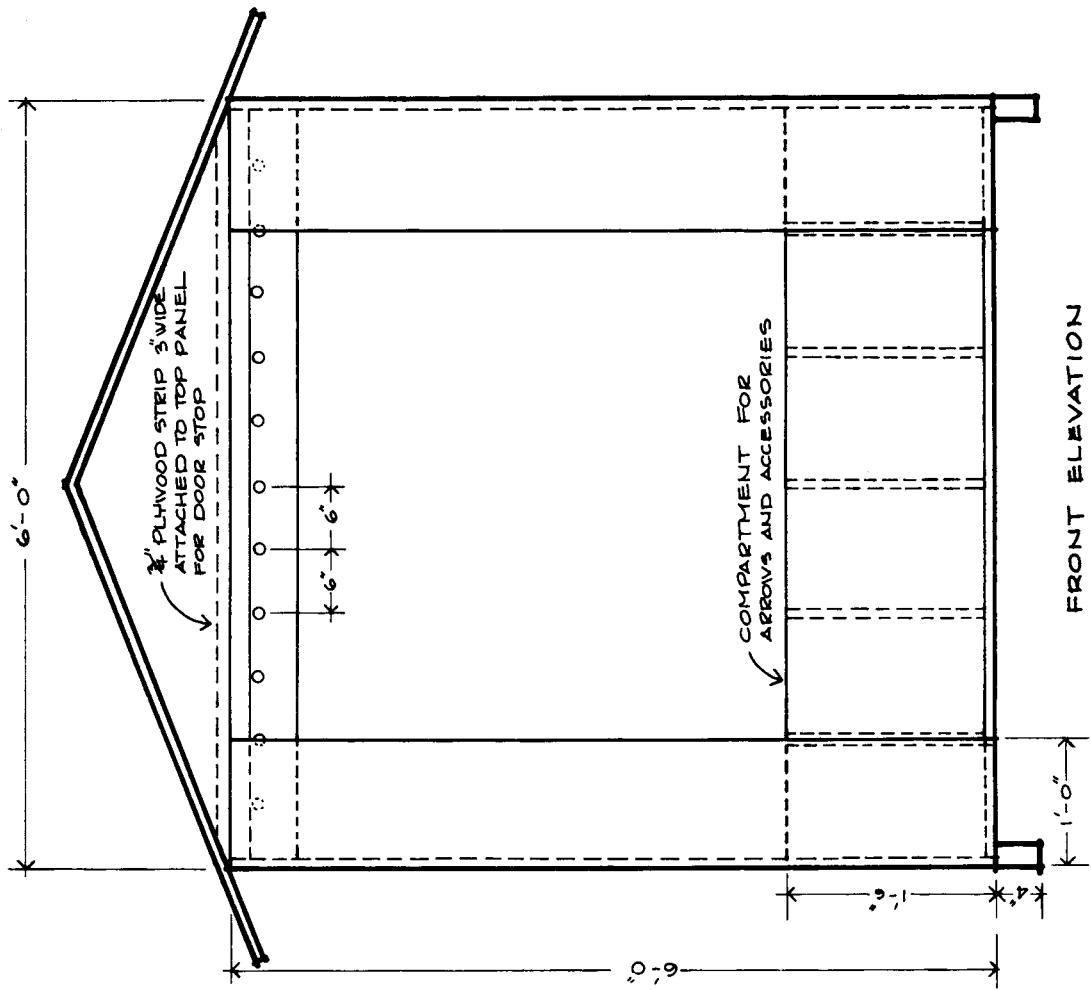
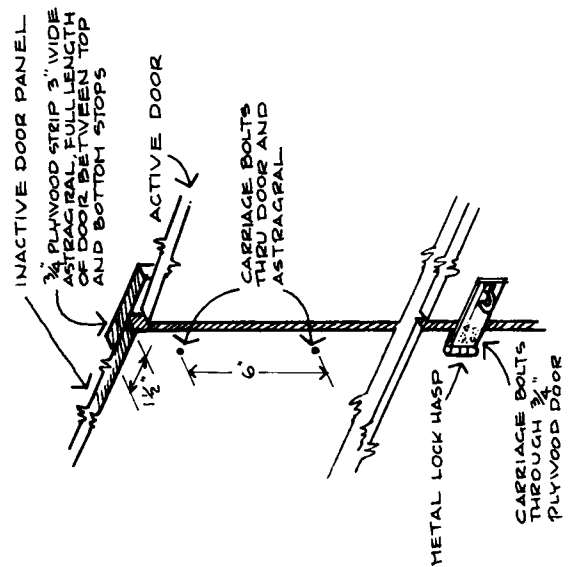

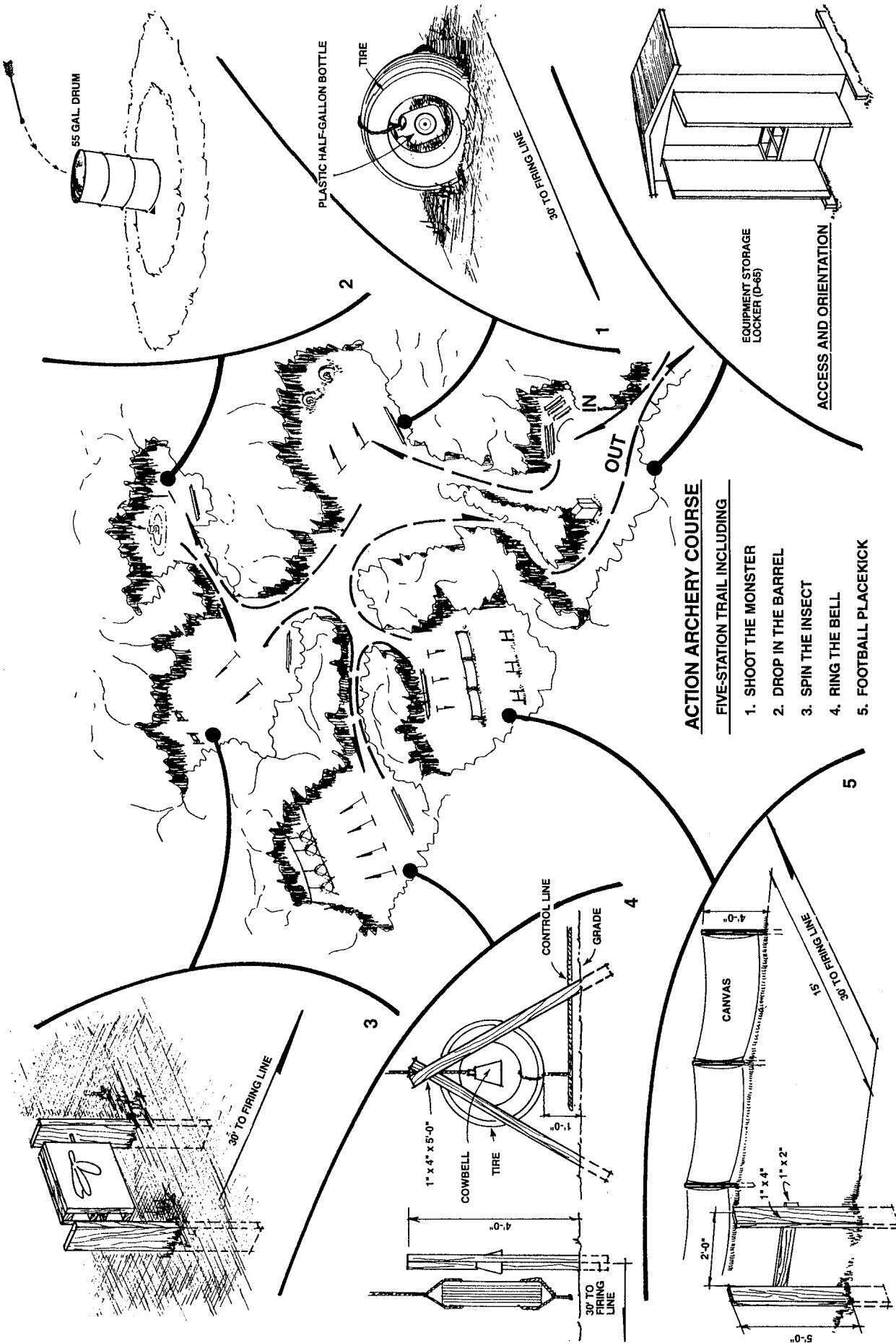

## Glossary

**action.** A group of moving parts used to cock, compress air (in some models), load, fire, and unload an air gun.

**air gun.** A gun that propels a projectile through its barrel by use of compressed air or carbon dioxide gas (CO<sub>2</sub>). Gunpowder is not used in this type of gun.

**anchor point.** The particular spot on the archer's face to which the index finger comes on the draw to give consistency to shooting.

**arm guard.** A piece of leather or plastic that is worn on the inside of the forearm to protect the arm from the bowstring.

**arrow plate.** A substance on the side of the bow to give point contact with the arrow.

**arrow rest.** An extraneous device on the bow to provide point contact; also a resting point.

**back.** The side of the bow that is away from the shooter.

**BB.** The term BB is used to describe spherical steel pellets that are .177 inch (4.5 mm) in diameter. However, steel BBs actually have a maximum diameter of .175 inch. BB projectiles for air guns should not be confused with the .181-inch-diameter BB pellets used in shotgun shells.

**blunt.** A blunt-tipped arrow, often used for small game.

**bolt.** A hard, metal projectile with a sharp, pointed nose and plastic fins inserted in the rear portion of the projectile.

**bore.** The inside of the barrel of a gun.

**bow arm.** The arm that holds the bow (not the string).

**bow sight.** A device attached to the bow that allows the shooter to sight directly on the target (which cannot be done with the arrow tip except at point-blank range).

**bowstring.** The string of a bow, usually made of Dacron.

**broadhead.** An arrow with a sharpened metal tip for hunting live game.

**butt.** A backstop for holding arrows shot at a target. The shoulder end of a rifle stock.

**caliber.** The diameter of a projectile, the distance between the lands in a rifled barrel, or the bore diameter in a smoothbore barrel.

**cant.** The act of holding the bow tilted or slightly turned while shooting.

**cast.** The distance a bow can shoot an arrow.

**CO<sub>2</sub> cylinder or tank.** A metal cylinder tank that contains carbon dioxide gas (CO<sub>2</sub>). Available in small disposable cylinders for insertion in some models of CO<sub>2</sub> pneumatic air guns; also available in large tanks that are used to charge refillable cylinders and internal gas reservoirs in other models.

**cocking lever.** The part of a spring-piston air gun used to cock a spring-loaded piston that compresses air at the instant of firing.

**compressed CO<sub>2</sub> /air pneumatic gun.** A type of air gun using carbon dioxide gas (CO<sub>2</sub>) or air that has been compressed and stored in a metal cylinder, or air that is compressed by an external air pump. This type of air gun allows the firing of multiple shots without recharging.

**creeping.** Letting the string hand edge forward before release.

**crest.** Paint or decoration on the arrow shaft near the feathers.

**cylindrical pellets.** A cylindrically shaped air gun pellet that usually has a raised band encircling its base to act as an air seal.

**dart.** A hard metal projectile with a sharp pointed nose and organic or artificial hair or feathers inserted in the rear portion of the projectile.

**dieseling.** The ignition and detonation of low-flash point lubricants due to the high temperature generated during the rapid compression of air in a spring-piston air gun.

**draw.** The acting of pulling the bowstring back into the anchor position.

**drawing arm.** The arm that draws back the bowstring.

**drift.** Natural deflection of an arrow from its normal path due to outside factors, such as wind.

**end.** A specified number of arrows shot at one time (or from one position) before retrieving.

**end loop.** The part of the string that fits over the bow nock.

**face.** The part of the bow facing the shooter; also a target face.

**fast.** An expression used to warn people of arrows being shot.

**field archery.** A competitive round shot at various distances and laid out like a golf course.

**field arrow.** An arrow with a field point; used outdoors for field archery, stump shooting, roving, and small game.

**finger tab.** A tab worn on the drawing hand to protect the fingers and give a smooth release of the bowstring.

**fletching.** The feathers of the arrow that give guidance to the arrow's flight.

**flight.** A competitive round of shooting for distance; also, the path of an arrow.

**forearm.** The part of the arm between the elbow and the wrist.

**free style.** Shooting with the aid of a bow sight.

**front sight.** The sight on the muzzle of a gun.

**glove.** A covering worn to protect the fingers from the string.

**grooves.** The shallow, spiral cuts in a bore that, together with the lands, make up the rifling in the bore of a barrel.

**handle riser.** The center part of the bow.

**head.** The tip or point of the arrow.

**hold.** The act of gripping the bow; hesitating at full draw.

**index.** The raised piece of plastic on the nock of an arrow that is in line with the cock feather.

**index vain.** The arrow feather at right angles to the nock; often of a different color than the other feathers.

**instinctive shooting.** Aiming and shooting arrows instinctively rather than using the pre-gap or point-of-aim methods or a bow sight.

**jerking.** Letting the drawing hand jerk too far back as the arrow is released.

**kick.** The recoil of the bowstring and bow after the arrow is released.

**laminated.** A composite bow, usually of wood and fiberglass.

**lands.** The ridges of metal between the grooves in a rifled barrel.

**limbs.** The two ends of a bow, from the handle riser out.

**longbow.** A bow with no recurve.

**multi-pump pneumatic air gun.** A type of pneumatic air gun that uses several strokes of a lever to compress and store enough air in a reservoir or chamber for one shot.

**muzzle.** The front end of the barrel from which a projectile exits.

**NRA.** National Rifle Association.

**nock.** The groove in the end of the arrow in which the bowstring fits; also, the groove at each end of the bow which holds the bowstring in place.

**nock locator.** The material on the bowstring used to indicate the exact nocking point for the arrow.

**nocking point.** The marked place on the bowstring where the arrow nock is placed before drawing and releasing.

**over-bowed.** Using a bow that is too heavy for the individual.

**overdraw.** Drawing the arrow back too far so that the tip passes the face of the bow. This is a dangerous practice.

**plinking.** Informal shooting at a variety of targets.

**pneumatic air gun.** A type of air gun that uses stored compressed air. Divided into two subcategories: single-stroke or multi-pump pneumatics and air pneumatics.

**point.** The tip on the end of the arrow.

**point-blank range.** The only distance from the target at which the point-of-aim is right on the target center.

**point-of-aim.** A method of aiming using a point, usually in front of the target, with which the point of the arrow is aligned; allows for trajectory of the arrow.

**pre-gap (pre-draw gap).** A method of aiming.

**projectile.** A body projected forward such as a bullet from a gun.

**quiver.** A container to hold arrows; can be ground, back, side, or pocket type.

**range officer.** A trained, certified, on-site adult who directs the operation of a range program in a shooting sport.

**rear sight.** The sight nearest the breech of a gun.

**recurve.** A bow that is curved on the ends.

**reflexed bow.** A bow with limb ends curving toward the back rather than toward the face of the bow.

**release.** The act of letting the bowstring slip off the fingertips.

**rifling.** Spiral grooves and lands in the barrel bore that provide a stabilizing spin to a projectile so that it will be more accurate in flight.

**roving.** An outdoor game played by two or more in which natural targets such as stumps, trees, or bushes are selected for accuracy competition.

**self arrow.** An arrow made entirely of one piece of wood.

**self bow.** A bow made entirely of one piece of wood, as opposed to other types of bows such as laminated.

**servicing.** The thread wrapped about the bowstring to prevent fraying of the string.

**shaft.** The middle of an arrow; an unfletched arrow.

**shelf.** The place on the bow where the arrow rests.

**shooting sports director.** The person who has overall responsibility for the operation of the shooting program for council camps and activities.

**sight alignment.** The relationship between the front and rear sights, where the shooter sees that the post bead, disc, or front sight device is aligned properly with the rear sight.

**sights.** Mechanical, optical, or electronic devices used to align the axis of the barrel on the target.

**sinking.** The gradual loss of a bow's power.



**single-stroke pneumatic air gun.** A type of pneumatic air gun that uses one stroke of a lever to compress and store enough air in a reservoir or chamber for one shot.

**small of stock.** The narrow part of a rifle stock.

**smoothbore.** An informal name for a gun that has a smoothbore barrel.

**smoothbore barrel.** A barrel that does not contain rifling.

**solid bow.** A common reference to a bow that is made entirely of fiberglass or plastics.

**spring-piston air gun.** A type of air gun that uses a manually operated lever or other device to cock a spring-loaded piston, which compresses air at the instant of firing. The air that propels the projectile is not stored in a reservoir prior to firing.

**stance.** A standing position assumed when shooting an arrow.

**stock.** The wooden or metal piece to which the barrel or mechanism of a rifle are attached.

**string.** Preparing a bow for shooting; also, the bowstring.

**string fingers.** The three fingers used to draw back the bowstring.

**string height.** The distance between the bow and the bowstring at the handle.

**strung bow.** A bow that is ready to shoot.

**target archery.** A competitive round shot at affixed distances in an open area.

**target arrow.** A lightweight arrow with a target point.

**throwing.** Moving the bow hand to the left upon release.

**understrung.** A bow with a bowstring that is too long.

**vane.** A plastic fletching on an arrow.

**weight.** The amount of effort (in pounds) required to draw the bow a given length (normally measured at 28 inches).

**weight in hand.** The actual weight of the bow.

**windage.** The amount of drift in the flight of an arrow caused by wind.

**wobble.** The erratic motion of a flying arrow.







## APPENDICES

1. NRA FIRST Steps/BSA Shotgun Shooting Merit Badge Teaching Guide
2. NRA FIRST Steps/BSA Rifle Shooting Merit Badge Teaching Guide
3. Sample Standard Operating Procedures Manual
4. Shooting Sports Decision Tree
5. Activity Consent Form, No. 680-673
6. Cub Scout and Webelos Scout BB Gun Shooting Sports
  - Training Archery Rangemasters
  - Training BB Gun Rangemasters
7. Private Property Approval for Shooting Sports by Units, Districts, and Councils
8. Prohibited Activities
9. Open Shooting Archery Experience
10. Instructional Archery Experience
11. Scouting Pistol Safety & Marksmanship
12. Multigun Airsoft Experience
13. Chalk Ball Program Guide
14. Cowboy Action Shooting Program Guide
15. Instructional Rifle Shooting Experience
16. Open Rifle Shooting Experience
17. Instructional Shotgun Experience
18. Open Shotgun Shooting Experience
19. Sporting Arrows
20. Cub Scout Shooting Sports Guide
21. Resources



## APPENDIX 1

# NRA FIRST STEPS SHOTGUN ORIENTATION INSTRUCTOR'S LESSON PLANS

## BOY SCOUTS OF AMERICA SHOTGUN SHOOTING MERIT BADGE TEACHING GUIDE

NRA FIRST Steps Firearm Instruction, Responsibility, and Safety Training Program First Edition  
©1995 The National Rifle Association of America

All rights reserved. Printed in the United States of America. This material may not be reproduced in whole or in part, by photocopying, mimeograph or by any other means without written permission. For information, write: Training Department, National Rifle Association, 11250 Waples Mill Road, Fairfax, VA 22030



# CONTENTS

Introduction.....	182
<b>DAY 1, LESSON I.</b>	
Introduction to Shotgun Safety, Parts, and Operation.....	182
<b>DAY 2, LESSON II.</b>	
Introduction to Ammunition and the Fundamentals of Shotgun Shooting .....	183
<b>DAY 3, LESSON III.</b>	
Introduction to Shotgun Shooting at Straightaway Targets .....	184
<b>DAY 4, LESSON IV.</b>	
Introduction to Shotgun Cleaning, Storage, and Training Opportunities .....	184

## INTRODUCTION

The certified NRA shotgun instructor who is serving as the merit badge counselor will need the following reference materials:

**NRA FIRST Steps Shotgun and Orientation Lesson Plans, No. 13392–3/2/10, and BSA Shotgun Shooting merit badge pamphlet, No. 35948.**

The purpose of this manual is to integrate the BSA Shotgun Shooting merit badge pamphlet with the NRA FIRST (Firearm Introduction, Responsibility and Safety Training) Steps Shotgun Orientation Lesson Plans to allow those NRA certified shotgun instructors who teach according to this manual to accumulate the ten courses and a total of 50 students required to be eligible to attend an NRA Training Counselor Workshop.

In teaching the Shotgun Shooting merit badge, the counselor/instructor must:

1. Follow the NRA FIRST Steps Shotgun Orientation Lesson Plans, adding the BSA merit badge requirements as noted. This outline applies **ONLY** to Merit Badge Option A—Modern Shotshell Type.
2. Reference **BOTH** the BSA Shotgun Shooting merit badge pamphlet and the NRA FIRST Steps Shotgun Orientation Lesson Plans to complete the Training Counselor Workshop eligibility requirement.

**Note:** There are a few requirements of the Shotgun Shooting merit badge that are not covered in the NRA FIRST Steps Shotgun Orientation Lesson Plans which must be supplemented accordingly.

Each Scout should have their own copy of the BSA Shotgun Shooting merit badge pamphlet.

**Revised 1/11/2014 to six hours (seven hours if five-day program)**

**Note:** If a Scout needs extra time in order to qualify for score, it is recommended that the merit badge counselor suggest that they return to the range during open shooting opportunities for further coaching.

### Day 1

#### **Lesson I. Introduction to Shotgun Safety, Parts, and Operation—1½ Hours**

##### **Paragraph A.** Orientation—10 minutes

Step 1: Have Scouts fill out their merit badge record card or council-furnished documentation.

Steps 2–9: Follow the NRA FIRST Steps Lesson Plans.

Step 10: Distribute the BSA Shotgun Shooting merit badge pamphlet instead of the FIRST Steps Shotgun book.

##### **Paragraph B.** Introduce Lesson—5 minutes.

Follow the NRA FIRST Steps Lesson Plan. Note that you are only stating the learning objectives for this lesson and not going into detail at this point.

##### **Paragraph C.** Shotgun Safety—20 minutes

Steps 1–2: Follow the FIRST Steps Lesson Plan.

Step 3: Teach the NRA Fundamental Rules for Safe Gun Handling.

**Note:** Step 3 covers BSA Requirement 2b. *Identify and demonstrate the rules for safely handling a shotgun.*

Refer Scouts to *Shotgun Shooting* merit badge pamphlet pages 23 and 24 titled “Fundamental Rules for Safe Gun Handling” and use NRA FIRST Steps Rule 3.

**Teach:** Follow *BSA Shotgun Shooting* merit badge pamphlet page 4, requirements 1a–b. The requirements are listed below along with references to teach from. **Note: These requirements are not found in the FIRST Steps Shotgun Lesson Plan.** Teach these requirements prior to continuing with the First STEPS Shotgun Lesson Plan Paragraph D.

BSA Requirement 1a.

*Explain why BB and pellet air guns must always be treated with the same respect as firearms.*

Refer Scouts to *Shotgun Shooting* merit badge pamphlet page 25, “BB and Pellet Air Guns.”

BSA Requirement 1b.

*Describe how you would react if a friend visiting your home asked to see your or your family's firearm(s).*

Refer Scouts to the *Shotgun Shooting* merit badge pamphlet. There is no exact quote. Use page 28, "Store guns so they are not accessible to unauthorized persons."

**Paragraph D.** Safe Shotgun Handling Practical Exercise—15 minutes

Follow the NRA FIRST Steps Lesson Plan.

**Note:** This covers BSA Requirement 2b.

*Identify and demonstrate the rules for safely handling a shotgun.*

Refer Scouts to *Shotgun Shooting* merit badge pamphlet pages 23 and 24 titled "Fundamental Rules for Safe Gun Handling."

**Paragraph E.** Shotgun Parts: Major Components—5 minutes

Steps 1–3: Teach as shown below.

**Note:** Teach all action types: pump, hinge, and semiautomatic.

BSA Requirement 2a.

*Identify the principal parts of a shotgun, action types, and how they function.*

Refer Scouts to *Shotgun Shooting* merit badge pamphlet page 10, "Shotgun Parts," and page 17, "The Safety."

**Paragraph F.** Shotgun Parts—5 minutes

Follow the NRA FIRST Steps Lesson Plan.

**Paragraph G.** Paragraph G was inadvertently skipped.

**Paragraph H.** Skip as this was just covered in depth above. Paragraph I. Shotgun Operation—5 minutes

Steps 1–2: Follow the NRA FIRST Steps Lesson Plan.

**Paragraph J.** Shotgun Operation Practical Exercise—5 minutes.

**Paragraph K.** Conclude Lesson—5 minutes

Steps 1–3: Follow the NRA FIRST Steps Lesson Plan.

## Day 2

### Lesson II. Introduction to Ammunition and the Fundamentals of Shotgun Shooting—1½ Hours

**Paragraph A.** Introduce Lesson—5 minutes

Follow the NRA FIRST Steps Lesson Plan.

**Paragraph B.** Shotgun Ammunition—10 minutes

1. Ammunition compatibility

**Note:** Follow the BSA *Shotgun Shooting* merit badge pamphlet page 5 requirements 2c and d. The requirements are listed below along with references to teach from. **These requirements are not found in the FIRST Steps Shotgun Lesson Plan.** Teach these requirements prior to continuing the FIRST Steps Shotgun Lesson Plan, Paragraph B item 2 *Ammunition malfunction*.

**Teach:** BSA Requirement 2c.

*Identify the parts of a shotgun shell and their functions.*

Refer Scouts to *Shotgun Shooting* merit badge pamphlet page 18, "Shotgun Ammunition," and page 19, "How Shotgun Ammunition Fires."

BSA Requirement 2d.

*Identify the various gauges of shotguns. Explain which one you would pick for use and why.*

**Paragraph B.** Shotgun Ammunition—10 minutes

2. Ammunition malfunction

**Note:** This covers BSA Requirement 2e.

*Explain what a misfire, hangfire, and squib fire are, and explain the procedures to follow in response to each.*

Reference *Shotgun Shooting* merit badge pamphlet page 21, "Ammunition Malfunctions."

**Paragraph C.** Determining the Dominant Eye—10 minutes Follow the NRA FIRST Steps Lesson Plan.

Reference *Shotgun Shooting* merit badge pamphlet pages 34–35.

**Paragraph D.** The Fundamentals of Shotgun Shooting—20 minutes

Follow the NRA FIRST Steps Lesson Plan.

**Note:** This covers BSA Requirement 2e.

*Identify and explain the fundamentals of safely shooting a shotgun.*

Reference *Shotgun Shooting* merit badge pamphlet pages 34–39, “Fundamentals of Shotgun Shooting.”

Practicing the Seven Fundamentals of Shotgun Shooting—30 minutes Follow the NRA FIRST Steps Lesson Plan.

**Paragraph E.** Conclude Lesson—5 minutes

### Day 3

#### **Lesson III. Introduction to Shotgun Shooting at Straightaway Targets—1½ Hours**

**Paragraph A.** Introduce Lesson—5 minutes  
Follow the NRA FIRST Steps Lesson Plan.

**Paragraph B.** Range Safety and Shooting Facility Orientation—5 minutes  
Teach Steps 1–4 as written in the NRA FIRST Steps Lesson Plan.

**Paragraph C.** Rules for Safe Shooting—5 minutes

**Note:** This covers the following requirements:  
BSA Requirement 2f.

*Identify and explain each rule for safely shooting a shotgun.*

BSA Requirement 1c.

*Explain the need for and use and types of eye and hearing protection.*

Reference *Shotgun Shooting* merit badge pamphlet pages 26–28, “Rules for Using or Storing a Shotgun.”

**Paragraph D.** Preparation for Shooting Exercises—5 minutes  
Follow the NRA FIRST Steps Lesson Plan.

**Paragraph E.** Shooting Straightaway Targets—90 minutes

**Note:** This covers BSA Requirement 2g.

*Demonstrate the knowledge, skills, and attitude necessary to safely shoot moving targets, using the fundamentals of shotgun shooting.*

Reference *Shotgun Shooting* merit badge pamphlet pages 34–44, “Fundamentals of Shotgun Shooting.”

**Note:** Teach BSA *Shotgun Shooting* merit badge pamphlet page 5 requirement 2k. This requirement is listed below along with a reference to teach from. **This requirement is not found in the FIRST Steps Shotgun Lesson Plan.** Teach this requirement prior to continuing with the FIRST Steps Shotgun Lesson Plan Paragraph F.

BSA Requirement 2k.

*Shooting score required—Hit at least 12 out of 25 targets (48 percent) in two 25-target groups. The two groups need not be shot in consecutive order.*

**Instructor’s Note:** The second Paragraph E. Review of Shooting Practice is a printing mistake. Re-letter the paragraph to Paragraph F and Paragraph F to Paragraph G.

**Paragraph F.** Review of Shooting Practice—5 minutes  
Follow the NRA FIRST Steps Lesson Plan.

**Paragraph G.** Conclude Lesson—5 minutes  
Follow the NRA FIRST Steps Lesson Plan.

### Day 4

#### **Lesson IV. Introduction to Shotgun Cleaning, Storage, and Training Opportunities—1½ Hours**

**Paragraph A.** Introduce Lesson—5 minutes  
Follow the NRA FIRST Steps Lesson Plan.

**Paragraph B.** Cleaning a Shotgun—15 minutes  
Teach steps 1–3 as written.

**Note:** This covers BSA Requirement 2i.

*Demonstrate how to clean a shotgun properly and safely.*

Reference *Shotgun Shooting* merit badge pamphlet pages 30–31, “Steps in Cleaning.”

**Paragraph C.** Hygienic Guidelines Following Exposure to Airborne Particulate Lead or Cleaning Solvent Residue—5 minutes  
Follow the NRA FIRST Steps Lesson Plan.

**Note:** This covers BSA Requirement 1g.

*Explain to your counselor the proper hygienic guidelines used in shooting.*

Reference *Shotgun Shooting* merit badge pamphlet page 32, “Shooting Hygiene.”



**Paragraph D.** Storing a Shotgun—5 minutes Teach steps 1–2 as written.

Teach BSA requirement 2j on page 5 of the BSA Shotgun Shooting merit badge pamphlet. Reference “Choosing a Shotgun” on pages 46–49.—5 minutes

**Note:** The requirement is listed below along with a reference to teach from. **This requirement is not found in the FIRST Steps Shotgun Lesson Plan.** Teach this requirement after Paragraph D and prior to continuing the FIRST Steps Shotgun Lesson Plan Paragraph E.

BSA Requirement 2j.

*Discuss what points you would consider in selecting a shotgun.*

Reference *Shotgun Shooting* merit badge pamphlet pages 46–49, “Choosing a Shotgun.”

**Paragraph E.** The “Next Step”: Additional Shotgun Shooting Activities—5 minutes Follow the NRA FIRST Steps Lesson Plan.

Teach merit badge requirements 1d through f and 1h through i, as listed on page 4 of the BSA *Shotgun Shooting* merit badge pamphlet. Other Shooting Activities—30 minutes

**Note:** The requirements are listed below along with references to teach from. **These requirements are not found in the FIRST Steps Shotgun Lesson Plan.** Teach these requirements following Paragraph E-4: *Other Shooting Activities.*

BSA Requirement 1d.

*Explain the main points of the laws for owning and using guns in your community and state.*

Consult state or local law enforcement.

BSA Requirement 1e.

*Explain how hunting is related to the wise use of renewable wildlife resources.*

Reference *Shotgun Shooting* merit badge pamphlet pages 81–82, “Conservation and Hunting.”

BSA Requirement 1f.

*Successfully complete a state hunter education course, or obtain a copy of the hunting laws for your state, then do the following:*

*(1) Explain the main points of hunting laws in your state and give any special laws on the use of guns and ammunition, and*

*(2) List the kinds of wildlife that can be legally hunted in your state.*

Refer to your state’s hunting regulations handbook.

**Note:** If a youth chooses to participate in a hunter education course, this merit badge training will take longer than the six to seven hours stated.

BSA Requirement 1h.

*Identify and explain three shotgun sports. Identify places in your community where you could shoot these sports and explain how you can join or be a part of shooting sport activities.*

Reference *Shotgun Shooting* merit badge pamphlet pages 51–59, “Clay Target Sports.”

BSA Requirement 1i.

*Give your counselor a list of sources that you could contact for information on firearms and their use.*

Reference *Shotgun Shooting* merit badge pamphlet pages 94–95, “Shotgun Shooting Resources.”

Conclude Lesson—5 minutes

## **Day 5—As Time Allows**

Continue qualification shooting as needed for the merit badge. If a Scout has met their shooting qualifications for the merit badge, have them continue shooting to qualify for the Winchester/NRA Qualification Program awards.



## APPENDIX 2

# NRA FIRST STEPS RIFLE ORIENTATION INSTRUCTOR'S LESSON PLANS

## BOY SCOUTS OF AMERICA RIFLE SHOOTING MERIT BADGE TEACHING GUIDE

NRA FIRST Steps Firearm Instruction, Responsibility, and Safety Training Program First Edition  
©1995 The National Rifle Association of America

All rights reserved. Printed in the United States of America This material may not be reproduced in whole or in part, by photocopying, mimeograph or by any other means without written permission. For information, write:  
Training Department, National Rifle Association, 11250 Waples Mill Road, Fairfax, VA 22030



# CONTENTS

Introduction.....	190
<b>DAY 1, LESSON I.</b>	
Introduction to Rifle Safety, Parts, and Operation .....	190
<b>DAY 2, LESSON II.</b>	
Introduction to Ammunition and the Fundamentals of Rifle Shooting.....	191
<b>DAY 3, LESSON III.</b>	
Introduction to Rifle Shooting From the Benchrest Position.....	192
<b>DAY 4, LESSON IV.</b>	
Introduction to Rifle Cleaning, Storage, and Training Opportunities.....	192

## INTRODUCTION

The certified NRA rifle instructor who is serving as the merit badge counselor will need the following reference materials:

**NRA FIRST Steps Rifle and Orientation Lesson Plans, No. 13212–1/2009, and BSA Rifle Shooting merit badge pamphlet, No. 35942.**

The purpose of this manual is to integrate the BSA *Rifle Shooting* merit badge pamphlet with the NRA FIRST (Firearm Introduction, Responsibility and Safety Training) Steps Rifle Orientation Lesson Plans to allow those NRA Certified Rifle Instructors who teach according to this manual to accumulate the ten courses and a total of 50 students required to be eligible to attend an NRA Training Counselor Workshop.

In teaching the Rifle Shooting merit badge, the counselor/instructor must:

1. Follow the NRA FIRST Steps Rifle Orientation Lesson Plans, adding the BSA merit badge requirements as noted. This outline applies ONLY to Merit Badge Option A—Modern cartridge type.
2. Reference BOTH the BSA *Rifle Shooting* merit badge pamphlet and the NRA FIRST Steps Rifle Orientation Lesson Plans to complete the Training Counselor Workshop eligibility requirement.

**Note:** There are a few requirements of the Rifle Shooting merit badge that are not covered in the NRA FIRST Steps Rifle Orientation Lesson Plans which must be supplemented accordingly.

Each Scout should have their own copy of the BSA *Rifle Shooting* merit badge pamphlet.

Revised 1/18/2014 to six hours (seven hours if five-day program)

## Day 1

### Lesson I. Introduction to Rifle Safety, Parts, and Operation—1½ Hours

#### Paragraph A. Orientation—5 minutes

Step 1: Have Scouts fill out their merit badge record card or council-furnished documentation.

Steps 2–10: Follow the NRA FIRST Steps Lesson Plans as written. However, distribute the BSA *Rifle Shooting* merit badge pamphlet instead of the NRA Basics of Rifle Shooting book to the Scouts.

#### Paragraph B. Introduce Lesson—5 minutes

Follow the NRA FIRST Steps Lesson Plan. Note that you are only stating the learning objectives for this lesson and not going into detail at this point.

#### Paragraph C. Rifle Safety—10 minutes

Steps 1–2: Follow the NRA FIRST Steps Lesson Plan.

Step 3: Teach the NRA's Three Fundamental Rules for Safe Gun Handling.

**Note:** Step 3 covers BSA Requirement 2b.

*Identify and demonstrate the three fundamental rules for safe gun handling.*

Refer Scouts to *Rifle Shooting* merit badge pamphlet page 18, "Fundamental Rules for Safe Gun Handling," and use NRA FIRST Steps C-3.

Teach merit badge requirements 1a and b.—5 minutes

**Note: These requirements are not found in the FIRST Steps Rifle Lesson Plan.** Teach these requirements prior to continuing with the FIRST Steps Rifle Lesson Plan to Paragraph D *Safe Rifle Handling Practical Exercise* listed below.

BSA Requirement 1a.

*Explain why BB and pellet air guns must always be treated with the same respect as firearms.*

Refer Scouts to *Rifle Shooting* merit badge pamphlet page 27, "Air Rifles."

BSA Requirement 1b.

*Describe how you would react if a friend visiting your home asked to see your or your family's firearm(s).*

Refer Scouts to *Rifle Shooting* merit badge pamphlet page 19, “Store guns so they are not accessible to unauthorized persons.”

**Paragraph D.** Safe Rifle Handling Practical Exercise—15 minutes

Follow the NRA FIRST Steps Lesson Plan.

**Note:** This covers BSA Requirement 2b.

*Identify and demonstrate the three fundamental rules for safe gun handling.*

Refer Scouts to *Rifle Shooting* merit badge pamphlet page 18, “Fundamental Rules for Safe Gun Handling.”

**Paragraph E.** Rifle Parts: Major Components—5 minutes

Follow the NRA FIRST Steps Lesson Plan Steps 1–3; however, teach as follows:

BSA Requirement 2a.

*Identify the three main parts of a rifle, and tell how they function.*

Refer Scouts to *Rifle Shooting* merit badge pamphlet page 8 and use the diagram.

**Paragraph F.** Rifle Parts—10 minutes

Teach as written in the NRA FIRST Steps Lesson Plan.

Refer Scouts to *Rifle Shooting* merit badge pamphlet diagram on page 8.

**Paragraph G.** Skip

**Paragraph H.** Rifle Operation—5 minutes

Steps 1: loading; 2: unloading. Follow the NRA FIRST Steps Lesson Plan.

**Paragraph I.** Rifle Operation Practical Exercise—15 minutes

Follow the NRA FIRST Steps Lesson Plan.

**Paragraph J.** Conclude Lesson—5 minutes

Follow the NRA FIRST Steps Lesson Plan.

If time allows, have Scouts shoot five rounds focusing on safety.

## Day 2

### Lesson II. Introduction to Ammunition and the Fundamentals of Rifle Shooting—1½ Hours

**Paragraph A.** Introduce Lesson—5 minutes

Follow the NRA FIRST Steps Lesson Plan. Keep it brief.

**Paragraph B.** Rifle Ammunition

1. Ammunition compatibility—5 minutes

**Note:** This covers BSA Requirement 2c.

*Identify the two types of cartridges, their parts, and how they function.*

Refer Scouts to *Rifle Shooting* merit badge pamphlet pages 35–36, “Ammunition.”

2. Cartridge malfunction—15 minutes

**Note:** This covers BSA Requirement 2d.

*Explain to your counselor what a misfire, hangfire, and squib fire are, and explain the procedures to follow in response to each.*

Refer Scouts to *Rifle Shooting* merit badge pamphlet page 37, “Malfunctions.”

**Paragraph C.** Determining the Dominant Eye—10 minutes

Follow the NRA FIRST Steps Lesson Plan.

Reference *Rifle Shooting* merit badge pamphlet, pages 39–40.

**Paragraph D.** Shooting Position—15 minutes

Follow steps a and b

**Paragraph E.** Fundamentals of Firing a Shot—25 minutes

Follow the NRA FIRST Steps Lesson Plan.

**Note:** This covers BSA Requirement 2e.

*Identify and demonstrate the five fundamentals of shooting a rifle safely.*

Reference *Rifle Shooting* merit badge pamphlet pages 39–44, “Rifle Shooting Fundamentals.”

**Follow-up shooting:** Scouts shoot for 15 minutes focusing on safety; can shoot longer if time allows.

**Paragraph F.** Conclude Lesson—5 minutes

### Day 3

#### **Lesson III. Introduction to Rifle Shooting From the Benchrest Position—1½ Hours**

**Paragraph A.** Introduce Lesson—5 minutes

Follow the NRA FIRST Steps Lesson Plan.

**Paragraph B.** Range Safety and Shooting Facility Orientation—10 minutes

Teach Steps 1–4 as written in the NRA FIRST Steps Lesson Plan.

**Paragraph C.** Rules for Safe Shooting—10 minutes

**Note:** This covers the following requirements:

BSA Requirement 2f.

*Identify and explain each rule for safe shooting.*

BSA Requirement 1c.

*Explain the need for, and use and types of, eye and hearing protection.*

Reference *Rifle Shooting* merit badge pamphlet pages 17–19, “Gun Safety.”

**Paragraph D.** Preparation for Shooting Exercises—10 minutes

Follow the NRA FIRST Steps Lesson Plan.

**Paragraph E.** Shooting From the Benchrest Position—45 minutes

**Note:** This covers BSA Requirement 2g.

*Demonstrate the knowledge, skills, and attitude necessary to safely shoot a rifle from the benchrest position or supported prone position while using the five fundamentals of rifle shooting.*

Reference *Rifle Shooting* merit badge pamphlet pages 39–44, “Rifle Shooting Fundamentals,” and pages 52–55, “Firing Your First Shots.”

**Note:** Follow BSA *Rifle Shooting* merit badge pamphlet page 5 requirements 2k and 2l. The requirements are listed below along with references to teach from.

**These requirements are not found in the FIRST Steps Rifle Lesson Plan.** Teach these requirements prior to continuing with the NRA FIRST Steps Rifle Lesson Plan, Paragraphs F and G.

BSA Requirement 2k.

*Using a .22 caliber rimfire rifle and shooting from a benchrest or supported prone position at 50 feet, fire five groups (three shots per group) that can be covered by a quarter. Using these targets, explain how to adjust sights to zero a rifle.*

BSA Requirement 2l.

*Adjust sights to center the group on the target and fire five groups (five shots per group). According to the target used, each shot in the group must meet the following minimum score: (1) A-32 targets—9; (2) A-17 or TQ-1 targets—7; (3) A-36 targets—5.*

**Paragraph F.** Review of Shooting Practice—5 minutes

Follow the NRA FIRST Steps Lesson Plan.

**Paragraph G.** Conclude Lesson—5 minutes

Follow the NRA FIRST Steps Lesson Plan.

**Note:** If a Scout is having difficulty with shooting for score, suggest they return during open shooting so that you can continue to coach them.

### Day 4

#### **Lesson IV. Introduction to Rifle Cleaning, Storage, and Training Opportunities—1½ Hours**

**Paragraph A.** Introduce Lesson—5 minutes

Follow the NRA FIRST Steps Lesson Plan.

**Paragraph B.** Cleaning a Rifle—40 minutes

Follow the NRA FIRST Steps Lesson Plans steps 1–3 as written.

**Note:** This covers BSA Requirement 2h.

*Identify the basic safety rules for cleaning a rifle, and identify the materials needed.*

Reference *Rifle Shooting* merit badge pamphlet page 30, “Cleaning.”

Teach step 4 Practical Exercise as written below.

**Note:** This covers BSA Requirement 2i.

*Demonstrate how to clean a rifle properly and safely.*

Reference *Rifle Shooting* merit badge pamphlet pages 31–32, “Steps in Cleaning.”



**Paragraph C.** Hygienic Guidelines Following Exposure to Airborne Particulate Lead or Cleaning Solvent Residue—5 minutes

Follow the NRA FIRST Steps Lesson Plan.

**Note:** This covers BSA Requirement 1h.

*Explain to your counselor the proper hygienic guidelines used in shooting.*

Reference *Rifle Shooting* merit badge pamphlet page 56, “Shooting Hygiene.”

**Paragraph D.** Storing a Rifle—5 minutes

Follow the NRA FIRST Steps Lesson Plan.

Teach merit badge requirement 2j—5 minutes

**Note: This requirement is not found in the FIRST Steps Rifle Lesson Plan.** Teach this requirement prior to continuing the FIRST Steps Rifle Lesson Plan Paragraph E.

BSA Requirement 2j

*Discuss what points you would consider in selecting a rifle.*

Reference *Rifle Shooting* merit badge pamphlet pages 23–27, “Choosing a Rifle.”

**Paragraph E.** The “Next Step”: Additional Rifle Shooting Activities—5 minutes

Follow the NRA FIRST Steps Lesson Plan.

Teach merit badge requirements 1d through f and 1h and 1i listed on page 4 of the *BSA Rifle Shooting* merit badge pamphlet—20 minutes

**Note:** The requirements are listed below along with references to teach from. **These requirements are not found in the NRA FIRST Steps Rifle Lesson Plan.**

BSA Requirement 1d.

*Give the main points of the laws for owning and using guns in your community and state.*

Consult local and state law enforcement for this information.

BSA Requirement 1e.

*Explain how hunting is related to the wise use of renewable wildlife resources.*

Reference *Rifle Shooting* merit badge pamphlet pages 80–82, “Conservation, Recreation, and More”

BSA Requirement 1f.

*Obtain a copy of the hunting laws for your state. Explain the main points of hunting laws in your state and give any special laws on the use of guns and ammunition.*

Reference *Rifle Shooting* merit badge pamphlet pages 82–83.

BSA Requirement 1g.

*Identify and explain how you can join or be a part of shooting sport activities.*

Reference *Rifle Shooting* merit badge pamphlet pages 86–89, “Olympic Games and Shooting.”

BSA Requirement 1i.

*Give your counselor a list of sources that you could contact for information on firearms and their uses.*

Reference *Rifle Shooting* merit badge pamphlet pages 95–96, “Shotgun Shooting Resources.”

**Paragraph F.** Conclude Lesson—5 minutes

Follow FIRST Steps Lesson Plan.

## **Day 5—As Time Allows**

Continue qualification shooting as needed for the merit badge. If a Scout has met their shooting qualifications for the merit badge, have them continue shooting to qualify for the Winchester/NRA Qualification Program awards.



## APPENDIX 3

### SAMPLE ONLY

**This is an example of one council's standard operating procedures.**

**Your council will need to write its SOP  
to account for individual range situations unique to its camp.**

## STANDARD OPERATING PROCEDURES FOR RIFLE, SHOTGUN, AND PISTOL RANGES

## I. Authorized Use of Range Facilities

- A. The council camp shooting ranges may be in operation only when the camp ranger gives permission. For special council/district events, shooting ranges must have the permission of council camping director.
- B. Council ranges will be under the supervision of a Range Safety Officer, 21 years of age or older, holding a current NRA Range Safety Officer certification. There must also be one or more NRA instructor(s) certified for that firearm, 21 years of age or older, holding a current NRA instructor certification. The ratio of NRA firearm-specific instructors to students is specified below.
- C. All Range Safety Officers and NRA-certified firearm instructors must have a copy of their certification(s) on file with the NRA training team/shooting sports committee as well as on their person while operating the range.
- D. The Range Safety Officer is responsible for the operation of a specific range. They are to run the range, maintain safety, and ensure all rules are followed. In order to fulfill these duties, the Range Safety Officer cannot be involved in any instruction during live fire.
- E. Rifle ranges have a ratio of one instructor to a maximum of eight students. There is also one Range Safety Officer per range.
- F. Shotgun ranges have a ratio of one instructor to one student. Current facilities can service no more than two participants and one trap. There is also one Range Safety Officer per range.
- G. Pistol ranges have a ratio of one instructor to two participants. Current facilities can service no more than six participants. There is also one Range Safety Officer per range.
- H. Range operation will conform to current national BSA standards and the *Guide to Safe Scouting*. Booklets may be obtained from your council or through [www.scouting.org/HealthandSafety/GSS/toc.aspx](http://www.scouting.org/HealthandSafety/GSS/toc.aspx)
- I. For every one hour that you are open exclusively for your own unit, you must be open two hours to the camp. If there are only a couple of troops, you can contact them first to see if they are interested and then set hours accordingly.
- J. Range equipment and ammunition will be checked out by the camp ranger to the Range Safety Officer and checked back in to the camp ranger.
- K. You may have only one class and caliber of firearm and ammunition on the range during live fire.
- L. The log with the standard operating procedures must be signed each time you run a range.

## II. Opening Range

- A. Check that there is sufficient eye and ear protection equipment present.
- B. Check the range and equipment for safety issues prior to the start of your sessions.
- C. When ready to open, put the range flag up to show that you are ready. (Current flag locations are marked.)

## III. Range Safety Briefing

- A. While gathered at a location outside the firing line:
  1. Introduce the range staff and who will be in charge of the range.
  2. Review the three “Fundamental Rules for Safe Gun Handling” (verbatim):
    - a. **Always** keep the gun pointed in a safe direction. (Declare that on this range “safe direction” means “toward the targets.”)
    - b. **Always** keep your finger off the trigger until ready to shoot.
    - c. **Always** keep the gun unloaded until ready to use.
  3. Review general range rules:
    - Know and obey all range commands.
    - No running or horseplay.
    - Listen to and obey the Range Safety Officer and instructor(s) at all times.
    - Shoot only at authorized targets.
    - Raise your hand to ask questions or to indicate a misfire (explain misfire).
    - Point out the spectator area.
    - Point out when and where eye and ear protection is or is not required.
    - Spectators must not converse with participants while they are on the range.
    - Participants and spectators ask permission to enter or exit the range.
    - **Remember SAFETY first.**
  4. Review equipment:
    - Explain how to hold the gun.
    - Explain how to operate the gun.
    - Explain how to sight in on the target.
    - Explain sight picture.
    - Explain how to load the gun and prepare to fire.
  5. Review the targets:
    - Explain to the participants what they will be shooting at.
    - Explain to them what they are attempting to do.
    - Discuss shot groupings.
  6. Eye and ear protection. Explain how to properly put them on and fit them as required.
  7. Eye dominance. Eye dominance should be checked with all participants.
  8. Shooting Fundamentals. Review the five shooting fundamentals:

- Position
  - Sight picture
  - Breathing
  - Trigger control
  - Follow-through
9. To indicate an EMERGENCY OR HAZARDOUS CONDITIONS.
- Use the command: **“CEASE FIRE!”**
  - Purpose: To stop all shooting routinely or, in the case of an emergency, immediately.
  - Action: Participants immediately stop shooting, continue to keep their muzzle pointed downrange, remove their finger from within the trigger guard, unload and clear the firearm as instructed, and wait for further instructions.
  - **A cease-fire can be called by anyone!**

#### B. Range commands and actions:

- To prepare the range for live fire, the following commands are recommended for you to use. Please use your discretion in using them:
  - Command: **“Move forward/take your position on the firing line.”**
    - Purpose: To get participants into position to prepare to begin shooting.
    - Action: Participants will move from behind the ready line to their assigned position. Remind them as required: **DO NOT TOUCH YOUR RIFLE!** Let them get comfortable, and ensure they are in the correct position.
  - Command: **“Protective gear on.”**
    - Action: Participants should put on their eye protection first, then ear protection.
  - Command: **“You may pick up your rifles.”**
    - Action: Participants will pick up their rifle, sight in on the target, make any final adjustments, and prepare to load.
  - Command: **“Load!”**
    - Purpose: To notify the Participants that they may load their first round.
    - Action: Participants will load their first round, close the bolt, keep their finger off the trigger, and wait for the next command.
  - Command: **“Is the line ready?”**
    - Purpose: To determine if all participants along the line are ready.
    - Action: All participants NOT ready should indicate their status to the Rangemaster. Sufficient time will be allowed for the participant to complete their preparation.
  - Command: **“Ready on the right?”**
    - Purpose: To declare that the participants have indicated they are ready on the right side of the range.
    - Action: Any participant not ready at this command may choose to either alert the Rangemaster that they are not ready or to complete the process of getting ready before the final command has been given.

- Command: **“Ready on the left?”**
    - Purpose: To declare that the participants have indicated they are ready on the left side of the range.
    - Action: Any participant not ready at this command may choose to either alert the Rangemaster that they are not ready or to complete the process of getting ready before the final command has been given.
  - Command: **“The firing line is ready.”**
    - Purpose: To notify all participants that the range is about to be under live fire.
    - Action: Participants simply await the next command. If anyone is not ready at that point, they should notify a Rangemaster. (Audible or raised hand)
  - Command: **“Commence firing!”**
    - Purpose: To declare that the range is formally open for live fire.
    - Action: The participants may commence the prescribed course of fire.
- To stop firing and declare the range safe:
    - Command: **“Cease fire!”**
      - Purpose: To stop all firing.
      - Action: All participants shall open the bolt, lay the rifle down with the bolt up, and remain in position until given further instructions. **If magazines are used, range commands must include “magazines out after firing all your shots”**
    - Command: **“Range is clear.”**
      - Purpose: The Range Safety Officer is telling all participants that all guns are unloaded.
    - Command: **“Remove protective gear.”**
    - Command: **“Pick up your brass, place it in the bucket, and get a new target.”**
    - Command: **“You may go change your targets.”**
      - Actions: Participants may move through the gate to the target area.

#### C. Move to the firing line gate:

- Review again the three Fundamental Rules for Safe Gun Handling (verbatim).
- Point out the ready line:
  - Participants DO NOT cross the line until instructed to do so by the Range Safety Officer.
  - Participants move back and forth across the line ONLY when instructed to do so by the Range Safety Officer.
  - Participants DO NOT touch the guns until instructed to do so by the Range Safety Officer.

### IV. Move Onto the Firing Line

- Stay behind the ready line.
- Explain the “prescribed course of fire,” e.g., how many rounds, time, targets, etc.

- C. Explain “Misfire!” and procedures:
- A misfire occurs when you pull the trigger and the gun does not fire.
  - Continue to keep the gun pointed at the target and raise your hand, and an instructor will assist you. Also explain “hang fire” and the procedure to be followed.
- D. Review the command “**Load.**”
- Upon this command, participants may load one round and prepare to fire, but **MUST NOT** fire until the command “Commence firing” is given.
- E. Review the command “**Cease fire**” and explain that participants may also call “Cease fire.”
- F. Begin the firing session:
- Command: “**Move forward/take your position on the firing line.**”
  - Command: “**Protective gear on.**”
  - Command: “**You may pick up your rifles.**”
  - Command: “**Load.**”
  - Command: “**Is the line ready?**”
  - Command: “**Ready on the right?**”
  - Command: “**Ready on the left?**”
  - Command: “**Ready on the firing line?**”
  - Command: “**Commence firing.**”
  - Command: “**Cease fire.**”
  - Command: “**Range is clear.**”
  - Command: “**Remove protective gear.**”
  - Command: “**Pick up your brass, place it in the bucket, and get a new target.**”
  - Command: “**You may go change your targets.**”
- G. Repeat the commands for each firing sequence.
- H. Leave the range through the gate.

## V. Closing Procedures

- A. Clear the range of all nonessential personnel.
- B. Put all range equipment away appropriately.
- C. Clean firearms properly.
- D. Remove flag when leaving range.
- E. Return all equipment to the ranger.
- F. Return signed SOP log book to the ranger.

## VI. Emergency Procedures

- A. Take charge of the situation.
- B. Render aid.
- C. Call for help.
- D. Direct medical help to the location.
- E. Take notes and file an incident report. (Incident report forms can be obtained from the ranger, council staff, or council office and must be filed with the ranger and council office.)

# APPENDIX 4 - SHOOTING SPORTS DECISION TREE

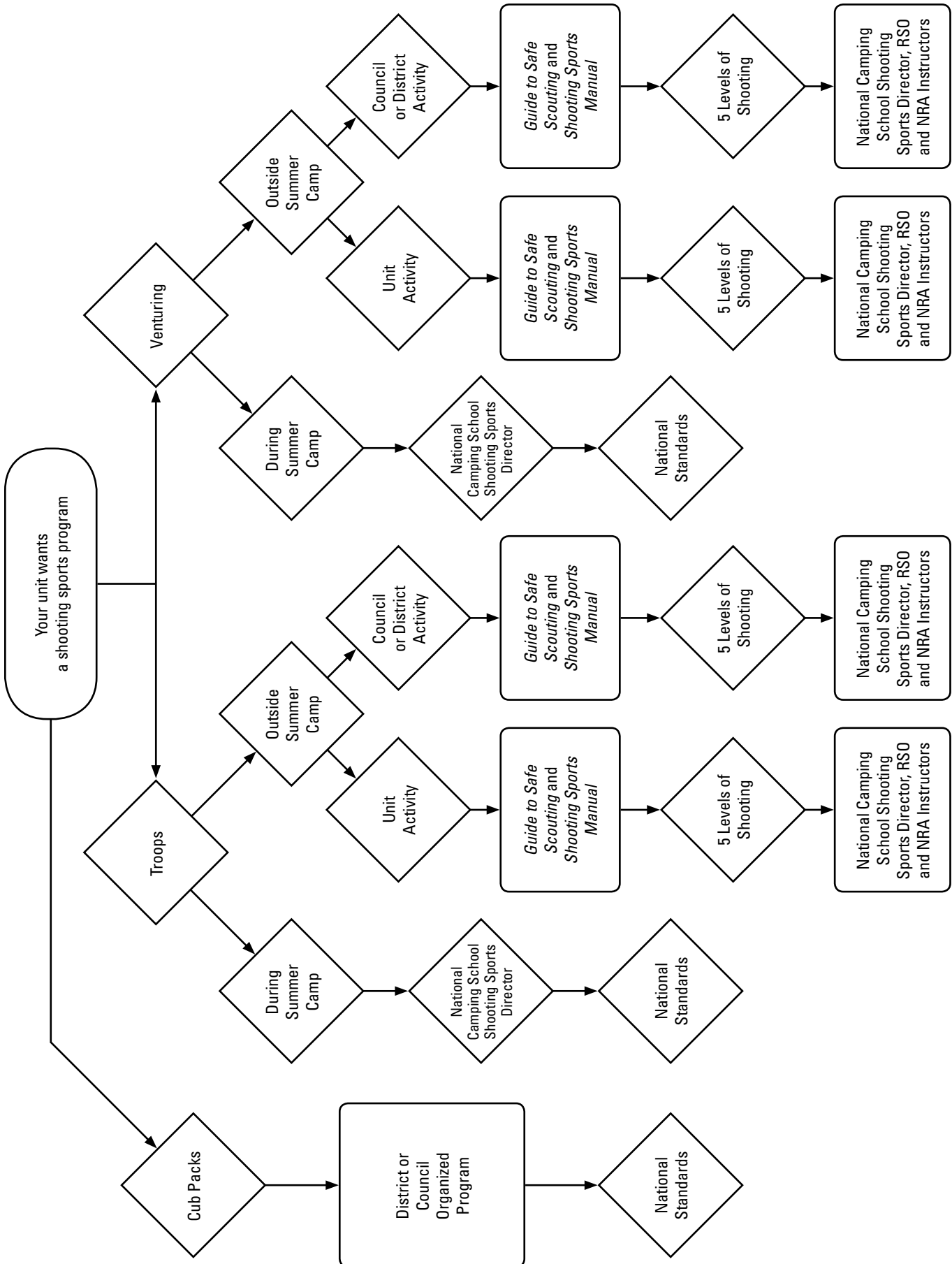

# APPENDIX 5 - ACTIVITY CONSENT FORM

## ACTIVITY CONSENT FORM AND APPROVAL BY PARENTS OR LEGAL GUARDIAN FORMULARIO DE CONSENTIMIENTO Y APROBACIÓN DE ACTIVIDAD POR PARTE DE LOS PADRES DE FAMILIA O TUTORES

The recommended use of this form is for the consent and approval for Cub Scouts, Boy Scouts, Varsity Scouts, Venturers, and guests to participate in a trip, expedition, or activity. It is required for use with flying plans.

El uso recomendado de este formulario es para obtener el consentimiento y aprobación para Cub Scouts, Boy Scouts, Varsity Scouts, Venturers, e invitados para participar en un viaje, expedición o actividad. Es obligatorio para su uso con planes de vuelo.

First name of participant Nombre del participante	Middle initial Inicial del segundo nombre	Last name Apellido
Birth date (month/day/year) _____ / _____ / _____ Fecha de nacimiento (mes/día/año)		Age during activity _____ Edad al momento de realizar la actividad

Address Domicilio		
City Ciudad	State Estado	Zip Código postal

Has approval to participate in (name of activity, orientation flight, outing trip, etc.) Tiene la aprobación para participar en (nombre de la actividad, vuelo de orientación, excursión, etc.)	From De	(Date) (fecha)	to a	(Date) (fecha)
--	------------	-------------------	---------	-------------------

### INFORMED CONSENT, RELEASE AGREEMENT, AND AUTHORIZATION

### CONSENTIMIENTO INFORMADO, CONVENIO DE EXONERACIÓN Y AUTORIZACIÓN

I understand that participation in Scouting activities involves the risk of personal injury, including death, due to the physical, mental, and emotional challenges in the activities offered. Information about those activities may be obtained from the venue, activity coordinators, or local council. I also understand that participation in these activities is entirely voluntary and requires participants to follow instructions and abide by all applicable rules and the standards of conduct.

Entiendo que la participación en actividades Scouting implica el riesgo de lesiones personales, incluyendo la muerte, debido a los retos físicos, mentales y emocionales en las actividades que se ofrecen. Se puede obtener información sobre dichas actividades en la sede, con los coordinadores de la actividad o el concilio local. También entiendo que la participación en estas actividades es totalmente voluntaria y requiere que los participantes sigan instrucciones y acaten todas las reglas y normas de conducta pertinentes.

In case of an emergency involving my child, I understand that efforts will be made to contact me. In the event I cannot be reached, permission is hereby given to the medical provider to secure proper treatment, including hospitalization, anesthesia, surgery, or injections of medication for my child. Medical providers are authorized to disclose protected health information to the adult in charge and/or any physician or health care provider involved in providing medical care to the participant. Protected Health Information/Confidential Health Information (PHI/CHI) under the Standards for Privacy of Individually Identifiable Health Information, 45 C.F.R. §§160.103, 164.501, etc. seq., as amended from time to time, includes examination findings, test results, and treatment provided for purposes of medical evaluation of the participant, follow-up and communication with the participant's parents or guardian, and/or determination of the participant's ability to continue in the program activities.

En caso de que mi hijo se vea involucrado en una emergencia, entiendo que se realizarán esfuerzos para contactarme. En caso de que yo no pueda ser localizado, por este medio otorgo permiso al proveedor de servicios médicos para garantizar el tratamiento adecuado, incluyendo hospitalización, anestesia, cirugía o inyecciones de medicamentos para mi hijo. Los proveedores de servicios médicos están autorizados a revelar información médica protegida al adulto a cargo, médico o proveedor de servicios médicos involucrado en la prestación de atención médica para el participante. La Información de salud protegida/Información médica confidencial (PHI/CHI, por sus siglas en inglés) bajo los Estándares de privacidad de información médica individualmente identificable, 45 C.F.R. §§ 160.103, 164.501, etc., y siguientes, como se enmiendan de vez en cuando, incluyen resultados de reconocimientos médicos, resultados de pruebas y el tratamiento proporcionado para fines de evaluación médica del participante, seguimiento y comunicación con los padres o tutor legal del participante, o determinación de la capacidad del participante para continuar en las actividades del programa.

With appreciation of the dangers and risks associated with programs and activities including preparations for and transportation to and from the activity, on my own behalf and/or on behalf of my child, I hereby fully and completely release and waive any and all claims for personal injury, death, or loss that may arise against the Boy Scouts of America, the local council, the activity coordinators, and all employees, volunteers, related parties, or other organizations associated with any program or activity.

Con reconocimiento de los peligros y riesgos asociados con los programas y actividades incluyendo preparativos y transporte hacia y desde la actividad, en mi propio nombre o en nombre de mi hijo, por este conducto eximo total y completamente, y renuncio a cualquier y toda reclamación por lesiones personales, muerte o pérdidas que puedan surgir, a la organización Boy Scouts of America, el concilio local, los coordinadores de la actividad y todos los empleados, voluntarios, grupos involucrados, u otras organizaciones asociadas con cualquier programa o actividad.

**NOTE: The Boy Scouts of America and local councils cannot continually monitor compliance of program participants or any limitations imposed upon them by parents or medical providers. List any restrictions imposed on a child participant in connection with programs or activities below and counsel your child to comply with these restrictions.**

**NOTA: La organización Boy Scouts of America y los concilios locales no pueden vigilar continuamente el cumplimiento de los participantes del programa o cualquier limitación impuesta sobre ellos por los padres o proveedores de servicios médicos. Enumerar más abajo las restricciones impuestas a un niño participante en relación con los programas o actividades.**

List participant restrictions, if any: \_\_\_\_\_  
 None

Restricciones del participante, si existen: \_\_\_\_\_  
 Ninguna

Participant's signature Firma del participante	Date Fecha	
Parent/guardian printed name Nombre con letra de molde del padre de familia/tutor	Parent/guardian signature Firma del padre de familia/tutor	Date Fecha

Area code and telephone number (best contact and emergency contact) Código de área y número telefónico (primer contacto y contacto de emergencia)	Email (for use in sharing more details about the trip or activity) Correo electrónico (para informar más detalles sobre el viaje o actividad)
--	--

Contact the adult leader with any questions:  
 Póngase en contacto con el líder adulto si es que tiene preguntas:

Name Nombre	Phone Teléfono	Email Correo electrónico
----------------	-------------------	-----------------------------



## APPENDIX 6 - CUB SCOUT AND WEBELOS SCOUT BB GUN SHOOTING SPORTS

### ***BB Gun Community Event Shooting Program***

A BB gun range can be set up at a community event, county or state fair, or other similar event. A BB gun shooting activity allows councils and districts to promote adventure as they recruit youth to the BSA. These events must be council- or district-sponsored only, not pack, den, or unit events.

**Youth.** Minimum age: Tigers through Webelos Scouts (already registered or of joining age)

**Equipment.** A smoothbore, spring-piston, or air rifle that propels BBs. The barrel velocity must be a maximum of 350 feet per second.

**Ammunition.** BBs only

**Participant safety.** Eye protection is required for all individuals on the range.

**Participant training/facility setup.** Spend five minutes reviewing the NRA's three rules of gun safety. Guns are tethered to a table and are loaded by instructors. Youth aim at targets and fire. Bench rest position only; large bull's-eye targets with a target carrier system; resetting metallic targets, balloons, or other fun, breakable targets.

**Range supervision and ratio.** One BSA BB Gun Rangemaster OR one currently certified National Camping School shooting sports director OR an NRA-certified rifle instructor for every eight participants AND one adult supervising each Cub Scout participant while shooting. These additional adults may be parents, legal guardians, or other responsible adults.

### ***BB Gun Open Shooting Program for Fun***

Councils and districts can conduct shooting sports programs for fun and to introduce Cub Scout- and Webelos Scout-aged youth to shooting sports programs while recruiting them into Scouting. These events must be council or district events only, not den, pack, or unit events.

**Examples.** This program could be a day-at-the-range event (fun shoot), NRA Day event (contact the National Rifle Association for information on NRA Day),

Winchester/NRA Marksmanship Qualification Program, Cuboree, or district or council camp weekend shooting event. A BB gun open shooting experience could be held at a BSA facility or at a facility that has been approved by the council for district- or council-level activities. These facilities may have previously held day camps or resident camps for BSA summer camping programs.

**Youth.** Tigers through Webelos Scouts

**Equipment.** Defined as a smoothbore, spring-piston, or air rifle propelling shot known as BBs. The barrel velocity must be a maximum of 350 feet per second.

**Ammunition.** BBs only

**Range.** A BSA-approved range. See page 162 in the National Shooting Sports Manual for range layout information and diagram.

**Training.** BSA BB gun briefing taught by a BSA Rangemaster, National Camping School shooting sports director, or an NRA-certified rifle instructor.

The NRA's three rules for safe gun handling will be taught, and the parts of a BB gun will be reviewed. See pages 55 and 61 of this manual.

**Participant safety.** Eye protection is required for all individuals on the range.

**Range supervision.** A BSA BB Gun Rangemaster, National Camping School shooting sports director, or an NRA-certified rifle instructor is to directly supervise the range, and one parent or legal guardian per participant must be present.

**Ratio.** One qualified instructor for every eight shooters AND one adult for each Cub Scout while they are shooting. These additional adults can be parents or guardians.

**Course.** Bench rest, prone, or standing. Targets could be paper, resetting metallic targets, balloons, or other fun, breakable targets. You can also use the Winchester/NRA Marksmanship Qualification Program.

## ***BB Gun District- or Council-Level Competitive Shooting Sports Program***

**Purpose.** Retention of Cub Scouts and Webelos Scouts by offering progressive, year-round shooting sports programs within a district and/or council. The program could begin with competition at a district level with the packs competing against each other, and the top pack in the district could advance to the finals competing against other packs at a councilwide event.

This event must be council- or district-sponsored only, not a den, pack, or unit event.

**Examples.** Ongoing programs include BB gun leagues sponsored by the district or council or a weekend BB gun event where the Cub Scouts and Webelos Scouts are invited to participate in a shooting event; Scouts shoot for high score, best shot, or other rankings.

**Youth.** Minimum age: Tiger Cub- through Webelos Scout-aged youth (already registered or of joining age)

**BB guns.** Smoothbore, spring-piston, or air rifle propelling shot known as BBs. The barrel velocity must be a maximum 350 feet per second.

**Ammunition.** BBs only.

**Range.** See pages 62-63 in this manual for range layout information and diagram.

**Training.** BSA BB gun briefing taught by Rangemaster, National Camping School shooting sports director, or an NRA-certified rifle instructor. See pages 57-58 of this manual for acceptable shooting positions.

**Safety.** Eye protection is required while using BB guns or air rifles.

**Range supervision.** A BSA BB Gun Rangemaster, National Camping School shooting sports director, or an NRA-certified rifle instructor must directly supervise the range.

**Ratio.** One qualified instructor for every eight participants.

**Course.** The format can be similar to a pinewood derby competition. A set number of weeks would be established, allowing the Scouts to shoot once a week and keep score. Scouts first shoot on a district level, with Scouts from different packs competing against each other to determine the top three shooters in the district. The top scorers would then move on to a final competition at the council level, and the top three would be awarded a council trophy.

# TRAINING ARCHERY RANGEMASTERS

Use this outline to train archery Rangemasters. (*Topics noted are included in this appendix unless otherwise noted.*)(**This training may only be conducted by a National Camping School Certified Shooting Sports Director OR an individual approved by the Council Shooting Sports Committee.**)

## Section I (75 min)

- A. How To Set Up An Outdoor Target Archery Range (*Use diagram in appendix*)
- B. A Brief History of Archery
- C. Safety
  - 1. Safety Guidelines
  - 2. Sun Safety on the Shooting Range
- D. Equipment
  - 1. Review bows, bowstrings, arrows, arm guards, finger tabs, quivers, points of aim, target butts, target faces, and backstops.
  - 2. Review how to string and unstring a bow, and have participants demonstrate this.
  - 3. Review how to maintain, store, and care for equipment.
- E. Range Layout
  - 1. This topic is to be taught on the archery range which was set up at the beginning of this section.
  - 2. Review the range layout, safety fencing, backstop, entryway, range flag, target spacing, waiting line, shooting line, and bow racks and quivers.
- F. Range Operation Rules
  - 1. Review range operation rules, including a sample Range Rules poster.

## Section II (40 min)

- A. Archery Shooting Basics
  - 1. Eye-Dominance
  - 2. Stance
  - 3. Nock and Arrow
  - 4. Establish the Bow Hold
  - 5. Draw
  - 6. Aim
  - 7. Anchor
  - 8. Release/Loose
  - 9. Follow-Through
  - 10. Retrieve Arrows
- B. Targets and Scoring
  - 1. Target Butts
  - 2. Target Faces (*cover scoring targets*)
  - 3. Backstops
- C. Know the Proper Whistle Commands

- 1. 2 blasts – advance to the shooting line
- 2. 1 blast – pick up bows, nock and arrow and begin shooting
- 3. 3 blasts – retrieve arrows
- 4. 5 or more blasts – EMERGENCY, STOP SHOOTING, BOWS DOWN

## D. Archery Practice Fun

- 1. One candidate will act as the range officer. Remainder of the group shoot on the range. (*This can be rotated through the archers as time permits.*)

## Section III (25 min)

- A. Training Cub Scouts
  - 1. Training Cub Scouts
  - 2. Teaching Tips
  - 3. Cub Scout Archery Training – Youth (*review syllabus*)
- B. Shooting a Competitive Round
  - 1. Differentiate between an end and a round
- C. Archery Games & Activities
  - 1. Review activities listed
  - 2. Ask archers to share any other activities they can think of.
- D. Cub Scouts and Archery
  - 1. Lions and Tigers MUST shoot with an adult partner
  - 2. Instructor to participant ratio for Cub Scouts is 1 instructor to 8 participants
- E. Cub Scout Shooting Awards
  - Cub Scout Shooting Sports Awards (Refer to ***Cub Scout Shooting Sports Guide***, No. 510-322, in Appendix 20 of this guide)
    - 1. Overview of Awards, pg. 206
    - 2. Overview of Archery Level 1 requirements, pg. 212
    - 3. Overview of Archery Level 2 requirements, pg. 216
- F. Slingshot
  - (Refer to ***BSA Shooting Sports Manual***, No. 430-938, **Other Shooting Activities (Slingshot)**)
    - 1. Equipment
    - 2. Targets
    - 3. Slingshot ammunition
- G. Slingshot
  - (Refer to ***BSA Shooting Sports Manual***, No. 430-938, **Other Shooting Activities (Slingshot)**)
    - 1. Slingshot and Wrist braced Slingshot Guidelines
    - 2. Range Commands (Refer to ***Cub Scout Shooting Sports Guide***, No. 510-322, in Appendix 20 of this guide)

# TRAINING BB GUN RANGEMASTERS

Use this outline to train BB gun Rangemasters. (*Topics noted are included in this appendix unless otherwise noted.*) (This training may only be conducted by a National Camping School Certified Shooting Sports Director OR an individual approved by the Council Shooting Sports Committee.)

## Section I (30 min)

- A. A Brief History of BB Guns
- B. Safety
  - 1. Safety Guidelines
  - 2. What Causes Gun Accidents
  - 3. Safety Reminders
  - 4. Sun Safety on the Shooting Range
- C. Equipment
  - 1. Parts of a BB Gun
    - a. Review diagram of Spring-Piston Gun (*If your camp uses a different gun, review the parts of that gun with participants.*)
    - b. Cover stock, butt, trigger, trigger guard, forearm, muzzle, front sight, barrel, rear sight, and safety.
    - c. Review how to load and unload the BB Gun
  - 2. Targets & Ammunition
    - a. Targets (Refer to **Cub Scout Shooting Sports Guide**, No. 510-322, in Appendix 20 of this guide)
    - b. Ammunition (bb's: .177 caliber spheres OR .177 caliber pellets)
  - 3. Equipment Maintenance & Storage
    - a. The BB Gun should be unloaded.
    - b. The safety mechanism should be engaged. (*If there is one.*)
    - c. The BB Gun should be protected from scratches and scraps from other guns.
    - d. The BB Gun should be locked or otherwise secured in a safe, dry location, separate from the ammunition.)

## Section II (35 min)

- A. Range Layout (*Use diagram in appendix.*)
  - 1. Review range layout, safety fencing, back-stop, entryway, range flag, target spacing, waiting line, and firing line.
  - 2. Set up a BB Gun range if possible. (*If not, re-inforce points from diagram on actual range.*)
- B. Range Operation Rules

## Section III (50 min)

- A. Training Cub Scouts
  - 1. Training Cub Scouts
  - 2. Teaching Tips

- 3. Review Cub Scout BB Gun Shooting Training outline
- B. BB Gun Shooting Basics
  - 1. Eye Dominance
  - 2. Shooting Shoulder
  - 3. Breathing
  - 4. Sight Alignment
  - 5. Trigger Squeeze
  - 6. Follow-Through
- C. Shooting Positions
  - 1. Free-Arm Standing Position
  - 2. Prone Position
  - 3. Kneeling Position
  - 4. Sitting Position
  - 5. Bench Rest Position (**Not in appendix, review if used in your camp.**)
- D. Safety Guidelines
  - 1. Review paragraph preceding basic rules.
  - 2. Review steps 1-12 with emphasis on first three:  
**Always keep the gun pointed in a safe direction.**  
**Always keep your finger off the trigger until ready to shoot.**  
**Always keep the gun unloaded until ready to use.**
- E. Range Commands
- F. BB Gun Shooting Practice
  - 1. Review three rules of safe gun handling.
  - 2. Review five basics of shooting.
  - 3. Have one of the candidates run at least one string of participants through the line.

## Section IV (35 min)

- A. BB Gun Shooting Games & Activities
  - 1. Fun Target Activities
  - 2. Tic Tac Toe
  - 3. Bikathlon
- B. Age Appropriate Guidelines for BB Gun
  - 1. Lion Cub Scouts – *Not permitted*
  - 2. Tiger Cub Scouts – Only with adult partner at council/district outdoor program
  - 3. Wolf, Bear, Webelos, and AOL – Only at council/district outdoor program
- C. Cub Scout Shooting Awards
  - Cub Scout Shooting Sports Awards (Refer to **Cub Scout Shooting Sports Guide**, No. 510-322, in Appendix 20 of this guide)
    - 1. Overview of Awards, pg. 206
    - 2. Overview of BB Gun Level 1 requirements, pg. 207
    - 3. Overview of BB Gun Level 2 requirements, pg. 210
- D. Slingshot (**BSA Shooting Sports Manual**, No. 430-938, **Other Shooting Activities**)

## APPENDIX 7 - PRIVATE PROPERTY APPROVAL FOR SHOOTING SPORTS BY UNITS, DISTRICTS AND COUNCILS

### Background: Why is this important?

1. The council and district(s) want to conduct shooting sports at district or council events off council property.
2. The council camp ranges are not available to units during the offseason.
3. Troops and crews are too far from council camps to use ranges for weekend programs.
4. Units are currently using private property for shooting programs with no provision to ensure safety.

The BSA's National Shooting Sports Task Force and Outdoor Programs/Properties Department always recommend hosting shooting sports programs at the council camp first. Councils are encouraged to make the camp ranges available for units to use in the offseason.

### Process for councils to approve private property range as venue for Scouting program:

1. Appoint a shooting sports chair and committee for the council with district representatives on the committee.
2. Appoint a certified NRA chief Range Safety Officer(s) to evaluate proposed private property ranges using the forms referenced below. Once the forms are completed, they are presented to the shooting sports committee and Scout executive for approval and are to be used by local units, districts, or the council.

3. The range is approved for two years if there are no changes to the range site or approved standard operating procedures.
4. Renewal is completed following the same process—review range use, reports of accidents and near misses, and demand for the range—to determine whether it is still adequate and needed for providing program for youth.
5. The council will keep a file in one location with all applications approved or not approved as part of the council's permanent records.

### Permission to Enter Upon and Use Land and Evaluation of Private Property Shooting Ranges—Private Property Range Evaluation Checklist

Download BSA form 430-065 and complete it before using any private land for any kind of shooting sports. The form is available at <https://www.scouting.org/outdoor-programs/shooting-sports/>

## APPENDIX 8 - PROHIBITED ACTIVITIES

For the BSA unauthorized activities, visit <https://www.scouting.org/health-and-safety/gss/gss07/>





# APPENDIX 9 - OPEN SHOOTING ARCHERY EXPERIENCE

## For Scouts BSA, Venturers And Sea Scouts

### INTRODUCTION

This guide is intended to provide units, districts and councils with an overview of the requirements for running the Archery program. All BSA Policies must be followed and instructors are required to be certified as a USA Archery Level 1 Instructor. In this publication, you will find youth requirements and training requirements for adults who are providing archery programs.

This program offers a fun and safe introduction to Archery.

### PROGRAM GUIDELINES

#### Youth Requirements

To participate in the archery program the following requirements must be met:

- Participants must be registered in Scouts BSA, Venturers or Sea Scouts
- Youth not registered in an official program must meet the required age guidelines to participate in a recruiting event.
- All youth participants are required to have written permission from their parent or guardian before they can take part in the program. A sample permission form is included in Appendix 1 of this guide. The council may also include this as part of the overall permissions for the camp or activity; however, it must clearly state that a child has the parent or guardian's permission to handle Archery equipment.



### STANDARD OPERATING PROCEDURES

The standard operating procedures (SOPs) of the range should also be reviewed by USA Archery Level 1 Instructor before delivering this program. All equipment must be approved for use by the USA Archery Level 1.

### THE RANGE

An approved range can include:

- BSA Range
- Public Range
- Private Range
- Commercial range
- Private Property Range.

Public, private property or commercial ranges must be certified using the application found here:

[Click here](#) or type this address in browser

<https://www.scouting.org/outdoor-programs/shooting-sports/permission/>

### ADULT SUPERVISION AND TRAINING REQUIREMENTS

1. BSA Youth Protection policies for two deep leadership must be maintained at all times.
2. Instructors must have current USA Archery Level 1 Instructor certification and be at least 18 years of age.

## APPLICABLE LAWS

BSA safety policies generally run parallel to or go beyond legal mandates. However, it is the camp or activity supervisor's responsibility to confirm and ensure compliance with all applicable federal, state, and local regulations or statutes related to youth using archery equipment.



## OPERATING PROCEDURES

The procedures outlined in the USA Archery Level 1 Instructor manual provides the guidelines for operating an indoor or outdoor archery range. All archery equipment used during the open shoot must be approved for use by the USA Archery Level 1 Instructor.

### THE RANGE

An approved range can include:

BSA Range  
Public or private commercial range  
Private property or club

Ranges must be set up under leadership of the USA Archery Level 1 Instructor.

### OPEN ARCHERY SHOOTING EXPERIENCE

**Purpose:** Introduce and recruit Scouts into archery shooting sports programs.

**Examples:** A day-at-the-range event (fun shoot), camporee, camp weekend shoot, or Order of the Arrow event are examples. An open shooting experience could be held at a BSA-approved facility, public, private, commercial or club range.

**Youth:** Scouts BSA and Venturers

**Training References:** Scouts BSA Archery Merit Badge Pamphlet; [Download Ranger Award Requirements](#)

**Equipment and Targets:** Age appropriate recurve or compound bows must be used.

Crossbows are not allowed. Manual and mechanical release systems are allowed. Any sighting systems can be used.

**Allowable arrows and targets:** All arrows must have target points. Requirements are set forth in the Merit Badge Pamphlet and Venture Award materials. No zombie or humanoid targets are allowed.

Target butts can be made of any penetrable materials so arrows will partially penetrate but not go through the butt material. Synthetic, foam and natural materials can be used in the manufacture of butts.

**Range:** A BSA-approved range or a public or private commercial range or club.

Note that if using private property for the range location, the USA Archery Level 1 Instructor manual provides safety distance guidelines for outdoor range inspection prior to approving a location for an archery range.

**Training:** USA ARCHERY Level 1 Instructor or higher level instructor certification.

**Safety:** Arm-guards and finger tabs or gloves are required. If mechanical releases are used the finger tabs or gloves are not required.

**Range supervision:** A certified USA ARCHERY Level 1 Instructor or higher. Student to Instructor ratio is 8:1.

Here are the whistle commands.

- 2 whistle blasts – Go to the line
- 1 whistle blast – Shoot
- 3 whistle blasts – Retrieve Arrows
- 5 or more blasts – Emergency. Immediately stop shooting, return bows to the rack, and go behind the waiting line

### BEFORE YOUTH ARRIVE AT THE PROGRAM AREA

All archery equipment, targets, stands and the physical range must be inspected for safety and preparedness prior to any participant's arrival at the shooting venue.

### ON THE RANGE

- Bows, arrows, safety equipment and targets will be at each shooting position
- General staging areas for shooters and those waiting their turn are clearly marked including the Waiting Line, Shooting Line and Target Line.



## RANGE INSPECTION CHECKLIST

Inspected by \_\_\_\_\_ Date \_\_\_\_\_

√ = Yes

- Controlled access/fencing/gates closed
- Flags or signs displayed
- Range limits identified
- Backstop/impact area inspected
- Range lines/area marked
- Spectator area designated
- Supplies available
- First-aid kit filled/accessible
- Range rules posted
- Bulletin board available
- Bow racks available
- Empty trash receptacles available
- Lockable storage
- Arm guards and finger protection available
- Hand washing Station Available

### RANGE SAFETY BRIEFING

Note: This briefing is best done within viewing site of the shooting range.

### ARCHERY SAFETY BRIEFING

- Safety is always #1
- To provide beginning shooters with Knowledge, Skill and Attitude (KSA) necessary to shoot a bow and arrow safely under direct supervision of a certified instructor.
- Archery range rules
  - Always walk on the range
  - Keep arrows in quiver until told to shoot
  - Only release the bow string when an arrow is nocked and safely pointed at the target
  - Leave dropped arrows on the ground until instructed to retrieve them
  - If there is an emergency on the range immediately alert the instructor
- Parts of a bow and parts of an arrow
- Demonstrate correctly nocking, drawing and shooting an arrow
- Shooting fundamentals
  - Stance
  - Nock
  - Hook and grip
  - Posture/Alignment
  - Raise bow

- Draw
- Anchor
- Transfer to hold
- Aim
- Release/follow through
- Feedback
- Explain range layout
  - Entrance/exit
  - Waiting Line
  - Shooting Line
  - Target Line
  - Safety Zones
  - Overshot areas
- Whistle commands
  - 2 whistle blasts – Go to the line
  - 1 whistle blast – Shoot
  - 3 whistle blasts – Retrieve Arrows
  - 5 or more blasts – Emergency. Immediately stop shooting, return bows to the rack, and go behind the waiting line.

**Before running a program check out the Shooting Sports Webpage for updates to this program guide and find other resources.**

**SAMPLE PERMISSION FORM**

**APPENDIX 1**

**Scouting Participation and Hold-Harmless Agreement**

\_\_\_\_\_ (Unit, District or Council) is conducting a shooting sports program.

Scouts will be instructed how to handle, maintain, and shoot Archery safely and be provided instruction to increase their shooting skills. Scouts will have classroom instruction and range instruction in which they will shoot Archery under the supervision of a trained USA Archery Level 1 or higher certified Archery Instructor.

Scouts will be required to wear arm-guard and finger tabs protection while on the range. Scouts are expected to abide by all safety rules and the instructions of the USA Archery Level 1 or higher Archery Instructor(s).

I, the undersigned, give my child, \_\_\_\_\_, permission to participate in this program. I understand that participation in the activity involves a certain degree of risk.

I have carefully considered the risk involved and have given consent for my child to participate in the activity. I understand that participation in the activity is entirely voluntary and requires participants to abide by the rules and standards of conduct. I release the Boy Scouts of America, the local council, the activity coordinators, and all employees, volunteers, related parties, or other organizations associated with the activity from all claims or liability arising out of this participation.

I understand that any additional cost associated with participation in this program will not be refunded if my child is removed due to behavioral problems. For safety, my child and I agree that they will do the following or they will be removed from the program:

1. Complete the training offered as part of the program.
2. Wear all safety gear while on the range.
3. Follow all safety rules provided in the training class.
4. Follow the instructions of the USA Archery Level 1 or higher Archery Instructor.
5. Do not handle any archery equipment until instructed to do so by the USA Archery Level 1 or higher Archery Instructor.
6. Follow the instructions of the USA Archery Level 1 or higher Archery Instructor.
7. Is registered as Scouts BSA, Sea Scout, or Venturer.

Participant signature \_\_\_\_\_ Date: \_\_\_\_\_

Parent/guardian signature \_\_\_\_\_ Date: \_\_\_\_\_

Parent/guardian printed name \_\_\_\_\_ Date: \_\_\_\_\_

Home phone \_\_\_\_\_ Cell phone \_\_\_\_\_

# APPENDIX 10 - INSTRUCTIONAL ARCHERY EXPERIENCE

## For Scouts BSA, Venturers And Sea Scouts

### INTRODUCTION

This guide is intended to provide units, districts and councils with an overview of the requirements for running the Archery program. All BSA Policies must be followed and instructors are required to be certified as a USA Archery Level 1 Instructor. In this publication, you will find youth requirements and training requirements for adults who are providing archery programs. This program offers a fun and safe introduction to Archery.

### PROGRAM GUIDELINES

#### Youth Requirements

To participate in the archery program the following requirements must be met:

- Participants must be registered in Scouts BSA, Venturers or Sea Scouts
- Youth not registered in an official program must meet the required age guidelines to participate in a recruiting event.
- All youth participants are required to have written permission from their parent or guardian before they can take part in the program. A sample permission form is included in Appendix 1 of this guide. The council may also include this as part of the overall permissions for the camp or activity; however, it must clearly state that a child has the parent or guardian's permission to handle Archery equipment.



### STANDARD OPERATING PROCEDURES

The standard operating procedures (SOPs) of the range should also be reviewed by USA Archery Level 1 Instructor before delivering this program. All equipment must be approved for use by the USA Archery Level 1.

### THE RANGE

An approved range can include:

- BSA Range
- Public Range
- Private Range
- Commercial range
- Private Property Range.

Public, private property or commercial ranges must be certified using the application found here:

[Click here](#) or type this address in browser

<https://www.scouting.org/outdoor-programs/shooting-sports/>

### ADULT SUPERVISION AND TRAINING REQUIREMENTS

1. BSA Youth Protection policies for two deep leadership must be maintained at all times.
2. Instructors must have current USA Archery Level 1 Instructor certification and be at least 18 years of age.

### APPLICABLE LAWS

BSA safety policies generally run parallel to or go beyond legal mandates. However, it is the camp or activity supervisor's responsibility to confirm and ensure compliance with all applicable federal, state, and local regulations or statutes related to youth using archery equipment.



## OPERATING PROCEDURES

The procedures outlined in the USA Archery Level 1 Instructor manual provides the guidelines for operating an indoor or outdoor archery range. All archery equipment used during the instructional shoot must be approved for use by the USA Archery Level 1 Instructor.

## THE RANGE

An approved range can include:

BSA Range  
Public or private commercial range  
Private property or club

Ranges must be set up under leadership of the USA Archery Level 1 Instructor.

## INSTRUCTIONAL ARCHERY SHOOTING EXPERIENCE

**Purpose:** Instruct youth in safe and fun archery shooting sports programs.

**Examples:** Scouts BSA Archery Merit Badge, USA Archery Level 1 or other recognized archery training. An instructional shooting experience could be held at a BSA-approved facility, public, private, commercial or club range.

**Youth:** Scouts BSA and Venturers

**Training References:** Scouts BSA Archery Merit Badge Pamphlet; [Download Ranger Award Requirements](#)

**Equipment and Targets:** Age appropriate recurve or compound bows must be used.

Crossbows are not allowed. Manual and mechanical release systems are allowed. Any sighting systems can be used.

**Allowable arrows and targets:** All arrows must have target points. Requirements are set forth in the Merit Badge Pamphlet and Venture Award materials. No zombie or humanoid targets are allowed.

Target butts can be made of any penetrable materials so arrows will partially penetrate but not go through the butt material. Synthetic, foam and natural materials can be used in the manufacture of butts.

**Range:** A BSA-approved range or a public or private commercial range or club. Note that if using private property for the range location, the USA Archery Level 1 Instructor manual provides safety distance guidelines for outdoor range inspection prior to approving a location for an archery range.

**Training:** USA ARCHERY Level 1 Instructor or higher level instructor certification for Merit Badge, USA Archery Level II Instructor is required for Level 1 instructor certification.

**Safety:** Arm-guards and finger tabs or gloves are required. If mechanical releases are used the finger tabs or gloves are not required.

**Range supervision:** A certified USA ARCHERY Level 1 Instructor or higher. Student to Instructor ratio is 8:1.

Here are the whistle commands.

- 2 whistle blasts – Go to the line
- 1 whistle blast – Shoot
- 3 whistle blasts – Retrieve Arrows
- 5 or more blasts – Emergency. Immediately stop shooting, return bows to the rack, and go behind the waiting line

## BEFORE YOUTH ARRIVE AT THE PROGRAM AREA

All archery equipment, targets, stands and the physical range must be inspected for safety and preparedness prior to any participant's arrival at the shooting venue.

## ON THE RANGE

- Bows, arrows, safety equipment and targets will be at each shooting position
- General staging areas for shooters and those waiting their turn are clearly marked including the Waiting Line, Shooting Line, and Target Line.

## RANGE INSPECTION CHECKLIST

Inspected by \_\_\_\_\_ Date \_\_\_\_\_

√ = Yes

- Controlled access/fencing/gates closed
- Flags or signs displayed
- Range limits identified
- Backstop/impact area inspected
- Ready lines/area marked
- Spectator area designated
- Supplies available
- First-aid kit filled/accessible
- Range rules posted
- Bulletin board available
- Bow racks available
- Empty trash receptacles available
- Lockable storage
- Arm guards and finger protection available
- Hand washing Station Available

### RANGE SAFETY BRIEFING

Note: This briefing is best done within viewing site of the shooting range.

### BSA ARCHERY SAFETY BRIEFING

- Safety is always #1
- To provide beginning shooters with Knowledge, Skill and Attitude (KSA) necessary to shoot a bow and arrow safely under direct supervision of a certified instructor.
- Archery range rules
  - Always walk on the range
  - Keep arrows in quiver until told to shoot
  - Only release the bow string when an arrow is nocked and safely pointed at the target
  - Leave dropped arrows on the ground until instructed to retrieve them
  - If there is an emergency on the range immediately alert the instructor
- Parts of a bow and parts of an arrow
- Demonstrate correctly nocking, drawing and shooting an arrow
- Shooting fundamentals
  - Stance
  - Nock
  - Hook and grip
  - Posture/Alignment
  - Raise bow
  - Draw
  - Anchor
  - Transfer to hold
  - Aim
  - Release/follow through
  - Feedback
- Explain range layout
  - Entrance/exit
  - Waiting Line
  - Shooting Line
  - Target Line
  - Safety Zones
  - Overshot areas
- Whistle commands
  - 2 whistle blasts – Go to the line
  - 1 whistle blast – Shoot
  - 3 whistle blasts – Retrieve Arrows
  - 5 or more blasts – Emergency. Immediately stop shooting, return bows to the rack, and go behind the waiting line. Before running a program check out the Shooting Sports Webpage for updates to this program guide and find other resources.

**SAMPLE PERMISSION FORM**

**APPENDIX 1**

**Scouting Participation and Hold-Harmless Agreement**

\_\_\_\_\_ (Unit, District or Council) is conducting a shooting sports program. Scouts will be instructed how to handle, maintain, and shoot Archery safely and be provided instruction to increase their shooting skills. Scouts will have classroom instruction and range instruction in which they will shoot Archery under the supervision of a trained USA Archery Level 1 or higher certified Archery Instructor. Scouts will be required to wear arm-guard and finger tabs protection while on the range. Scouts are expected to abide by all safety rules and the instructions of the USA Archery Level 1 or higher Archery Instructor(s). I, the undersigned, give my child, \_\_\_\_\_, permission to participate in this program. I understand that participation in the activity involves a certain degree of risk. I have carefully considered the risk involved and have given consent for my child to participate in the activity. I understand that participation in the activity is entirely voluntary and requires participants to abide by the rules and standards of conduct. I release the Boy Scouts of America, the local council, the activity coordinators, and all employees, volunteers, related parties, or other organizations associated with the activity from all claims or liability arising out of this participation. I understand that any additional cost associated with participation in this program will not be refunded if my child is removed due to behavioral problems. For safety, my child and I agree that they will do the following or they will be removed from the program:

1. Complete the training offered as part of the program.
2. Wear all safety gear while on the range.
3. Follow all safety rules provided in the training class.
4. Follow the instructions of the USA Archery Level 1 or higher Archery Instructor.
5. Do not handle any archery equipment until instructed to do so by the USA Archery Level 1 or higher Archery Instructor.
6. Follow the instructions of the USA Archery Level 1 or higher Archery Instructor.
7. Is registered as Scouts BSA, Sea Scout, or Venturer.

Participant signature \_\_\_\_\_ Date: \_\_\_\_\_

Parent/guardian signature \_\_\_\_\_ Date: \_\_\_\_\_

Parent/guardian printed name \_\_\_\_\_ Date: \_\_\_\_\_

Home phone \_\_\_\_\_ Cell phone \_\_\_\_\_



# APPENDIX 11 - SCOUTING PISTOL SAFETY & MARKSMANSHIP

## INTRODUCTION

The Boy Scouts of America is proud to partner with the National Rifle Association to provide youth with a beginner pistol experience that focuses on the safe and responsible use of firearms. This program is only for use in council or district-level camps and activities. Units may not conduct this activity.

This guide is intended to provide councils and districts with an overview of the requirements for running the Scouting Pistol Safety and Marksmanship program. In this publication, you will find youth requirements, training requirements for adults who are providing the program, and sample budgets for running this program in camp and weekend program venues.



## YOUTH REQUIREMENTS

- Scouts BSA and Venturers who are over the age of 14, or are 13 and have completed the eighth grade, may participate in this activity.
- All youth participants are required to have written permission from their parent or guardian to fire a handgun before they can take part in the program. A sample permission form is included at the end of this document. The council may also include this as part of the overall permissions for the camp or activity; however, it must clearly state that a child has the parent or guardian's permission to handle and fire a handgun.

## ADULT SUPERVISION AND TRAINING REQUIREMENTS

BSA Youth Protection policies for two-deep leadership must be maintained at all times.

- The Scouting Pistol Safety and Marksmanship program can be conducted only by NRA-certified pistol instructors.
- At least two of the instructors on the range must also hold a Scouting Pistol Safety and Marksmanship program certification. In addition, one of these instructors must hold an NRA Range Safety Officer rating. This training focuses specifically on how

to present the program to youth effectively and in a fun and engaging way. To find out more about this training, as well as when training is available, visit <https://www.scouting.org/outdoor-programs/shooting-sports/>



## PROGRAM GUIDELINES

### APPLICABLE LAWS

BSA safety policies generally run parallel or go beyond legal mandates. However, it is the camp or activity supervisor's responsibility to confirm and ensure compliance with all applicable federal, state, and local regulations or statutes related to youth handling and using a firearm.

### BSA GUIDELINES

This is a Level 3 shooting sports activity and must follow all guidelines in the *Boy Scouts of America National Shooting Sports Manual*, No. 430-938.

- The instructor-to-youth ratio when on the range working with the firearm is one NRA certified pistol instructor to every two youth, plus at least one NRA certified Range Safety Officer per every six youth. The RSO cannot function as an instructor.
- At least one of the NRA certified pistol instructors and one RSO per range must also hold a Scouting Pistol Safety and Marksmanship program certification.
  - One or both of the instructors who hold the program certification will act as lead instructor for the classroom portion of this course. Other NRA certified pistol instructors who have not attended the additional program training can help show the firearm and work with youth on the demonstrations, but should not present the material to the class.
  - On the range, the RSO who holds the additional pistol program certification will be the lead RSO and should give the range

commands. NRA certified pistol instructors will oversee the youth to ensure proper gun handling, dispense ammunition, provide coaching, and ensure that range safety commands given by the RSO are followed.

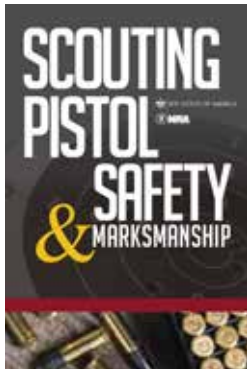

The instructors for the course will use the NRA FIRST Steps syllabus for this course. They should have received a syllabus as a part of their NRA pistol certification course. If they do not have a copy of the most updated syllabus, one can be obtained via the NRA training portal at [www.nrainstructors.org](http://www.nrainstructors.org).

Each youth should have a personal copy of *Scouting Pistol Safety and Marksmanship*, which is available through their local Scout shop (SKU 622175). Youth will be asked to follow the instructor in this book and will be encouraged to take notes. This book will also act as a reference for safety and maintenance of the firearm after youth have completed the course.

Upon successful completion of the course, each youth will be given a pocket card (SKU 623012), which is available for council purchase through Supply.

**Only .22-caliber handguns should be used in this program.** Only one type of action should be demonstrated and used per program session.

### STANDARD OPERATING PROCEDURES

**The FIRST Steps syllabus must be used and adhered to as written. No sections should be moved or changed. Youth range instruction should happen in the order assigned in the course syllabus.**

The FIRST Steps program is designed to be a four-hour safety and marksmanship training course.

Before beginning this program, a program hazard analysis should be conducted for the range and this program as outlined in National Camp Accreditation Program standard PD-111 ([www.scouting.org/ncap](http://www.scouting.org/ncap)). The enterprise risk management committee for the council should review the analysis as per standard PD-112. The program hazard analysis instructions and template can be found at <http://www.scouting.org/filestore/pdf/680-009.pdf>

Your range's standard operating procedures should also be reviewed and updated to reflect the requirements for delivering this program. Sample range SOP's can be found in the *BSA National Shooting Sports Manual* under appendix 3 if you do not already have them for your range.





## SAMPLE BUDGET

Below is a sample startup, one-year budget for a pistol range with six shooting positions, 12 youth per program session, and 10 program sessions per year (costs may vary by council).

ONE-TIME STARTUP COSTS		
NRA pistol certification	3 instructors and 1 RSO (\$275 each)	\$1,100
Handguns	8 pistols (\$225 each)	\$1,800
Total one-time costs:		\$2,900
ONGOING YEARLY ESTIMATED COSTS		
Books for youth	Estimate 120 youth per year (\$9.99 each)	\$1,200
Ammunition	.22 long rifle (\$.05 per round/300 rounds per youth)	\$1,800
Gun cleaning consumables		\$150
Program certification training—cost of travel and living	1 NRA pistol instructor and 1 RSO per range	\$350
Ear protection	18 ear muffs (\$16 each)	\$288
Ear protection	1 box of 100	\$33
Eye protection	18 (\$5 each)	\$90
Printing	Safe gun handling guidelines	\$50
Paper plates for targets	100 pack	\$6
<b>Total estimated yearly costs:</b>		<b>\$3,967</b>

*Note:* Budget above does not include camp staff salaries or range construction or improvements.



## SAMPLE PERMISSION FORM

Camp \_\_\_\_\_

*Scouting Pistol Safety and Marksmanship Program Participation and Hold-Harmless Agreement*

Camp \_\_\_\_\_ (\_\_\_\_\_ Council) is conducting a Scouting Pistol Safety and Marksmanship program. Scouts will be instructed how to handle, maintain, and shoot a pistol safely and be provided instruction to increase their marksmanship skills. Scouts will have classroom instruction and range instruction in which they will fire a pistol under the supervision of a trained Range Safety Officer and NRA certified pistol instructor. Scouts will be required to wear eye protection and ear protection at all times while on the range. Scouts are expected to abide by all safety rules and the instructions of the Range Safety Officer(s) and pistol instructor(s).

I, the undersigned, give my child, \_\_\_\_\_, permission to participate in this program. I understand that participation in the activity involves a certain degree of risk. I have carefully considered the risk involved and have given consent for my child to participate in the activity. I understand that participation in the activity is entirely voluntary and requires participants to abide by the rules and standards of conduct. I release the Boy Scouts of America, the local council, the activity coordinators, and all employees, volunteers, related parties, or other organizations associated with the activity from any and all claims or liability arising out of this participation.

**For safety, my child and I agree that they will do the following or they will be removed from the program.** I understand that any additional cost associated with participation in this program will not be refunded if my child is removed due to behavioral problems.

1. Complete the FIRST Steps class taught at Camp \_\_\_\_\_.
2. Wear all safety gear at all times while on the range.
3. Follow all safety rules provided in the training class.
4. Follow the instructions of the Range Safety Officer(s) and pistol instructor(s).
5. Do not handle any pistols until instructed to do so by the pistol instructor(s).
6. Follow the instructions of the Range Safety Officer(s) at all times.
7. Is 14 years of age, or 13 and has completed the eighth grade, as of the start of the class and will be in full compliance with all local, state, and federal guidelines, including age restrictions and original equipment manufacturer standards.

Participant signature \_\_\_\_\_ Date: \_\_\_\_\_

Parent/guardian signature \_\_\_\_\_ Date: \_\_\_\_\_

Parent/guardian printed name \_\_\_\_\_ Date: \_\_\_\_\_

Home phone \_\_\_\_\_ Cell \_\_\_\_\_ Date: \_\_\_\_\_

# APPENDIX 12 - MULTIGUN AIRSOFT EXPERIENCE

## ACKNOWLEDGEMENTS

The Boy Scouts of America, in cooperation with the National Rifle Association, is proud to present the Multi-Gun Airsoft Experience, a fun recreational program for new and intermediate shooters. This guide is a Boy Scouts of America adaptation of the *NRA 3 Gun Experience Guidebook*. The BSA greatly appreciates the NRA for their continuing commitment and contributions to Scouting.

Multi-Gun Airsoft Experiences offer a great introduction to the fastest growing shooting sport in the world, 3 Gun. These safe, family-friendly events can help councils reach new members and retain existing ones.

No BSA council, district, or unit is authorized to host, demonstrate, or otherwise present any sort of airsoft program unless the policies and procedures in this *Operations Guide* are followed.

## CONTENTS

### 141 INTRODUCTION

- 141 A Word About Safety
- 142 BSA-Authorized Airsoft Activity
- 142 Required Staff
- 143 Airsoft Range Layout
- 144 Selecting and Building Targets
- 144 Planning the Course of Fire
- 145 Shopping for Airsoft Guns
- 145 NRA Foundation Grants
- 145 Releases
- 145 Event Preparation
- 146 APPENDIXES
- 146 Appendix 12a: Glossary
- 147 Appendix 12b: Frequently Asked Questions
- 148 Appendix 12c: Safety Briefing
- 148 Appendix 12d: First Aid and Emergency Planning
- 149 Appendix 12e: Airsoft Endorsement
- 149 Appendix 12f: Approved Vendors
- 150 Appendix 12g: Permitted Airsoft Guns and Accessories
- 151 Appendix 12h: Sample Airsoft Target Construction
- 153 Appendix 12i: Sample Range Layout (Single-Bay)
- 154 Appendix 12j: Sample Range Layout (Multi-Bay)

## INTRODUCTION

Airsoft uses plastic 6-millimeter spherical balls that are sometimes called airsoft BBs or pellets. Airsoft guns use compressed gas or a spring or electric motor to drive air out of the gun to propel the BBs. Airsoft guns come in three authorized formats: pistol, rifle, and shotgun.

The Multi-Gun Airsoft Experience differs from most shooting activities in that all participants use two or all three types of the airsoft guns. Note that fully automatic use of airsoft guns is prohibited. Airsoft guns that have a “select fire” capability must remain in semi-automatic or safe mode at all times.

Each individual shooter is paired with an instructor in their own dedicated shooting bay. A coach may also assist the shooter using the coach/pupil method. All shooting is done from a standing position except to accommodate shooters with special needs.



## A WORD ABOUT SAFETY

While every attempt has been made in this guide to outline a fun and safe program, those efforts cannot replace review and vigilance at the point of program execution. [The Event Safety Checklist](#) in the *Guide to Safe Scouting* and the [Program Hazard Analysis](#) found in the [Scouting Safely](#) section on [Scouting.org](#) can assist local operators in discussing safety conditions specific to their area.

Safety is integrated into the program by design but is not necessarily called out as such. This includes range layouts, limitations on the guns used, and requirements for eye protection as well as the need for qualified supervisors who know and understand the equipment being used.

This *Operations Guide* contains the program in its entirety. Multi-gun activities outside of these parameters have not been evaluated and are not considered official Scouting activities.

This operations guide will be revised occasionally as changes are made to equipment, operation, and technology, so please keep an eye out for updates. The latest version is available [online](#).

## BSA-AUTHORIZED AIRSOFT ACTIVITY

All BSA councils, districts, and units are required to follow the specifications in this guide when sponsoring or conducting Multi-Gun Airsoft Experiences. Districts and units are prohibited from using airsoft guns unless permission is provided by their council.

The use of airsoft is not authorized in the Cub Scout program.

ACTIVITY SPONSOR	SCOUTS BSA	VENTURING & SEA SCOUTS	EXPLORING & LFL
COUNCIL	P, R, S	P, R, S	P, R, S
DISTRICT*	P, R, S	P, R, S	P, R, S
UNIT**	P, R, S	P, R, S	P, R, S

Appendix 7 lists all BSA-approved airsoft equipment by make, model, and manufacturer. *No other airsoft guns are permitted regardless of similarity.* Use the table above to determine which of the three formats (P = pistol, R = rifle, S = shotgun) are allowed in your activity.

Airsoft is not an authorized activity for Cub Scouts.

\* Districts must receive permission from the council Scout executive, or authorized delegate, and the council shooting sports committee before conducting any events involving airsoft guns. Permission is granted on a calendar-year basis and is good for all district-sponsored events to be conducted that year.

\*\* Units must receive permission from their district executive and the council shooting sports committee before conducting any event involving airsoft guns. Permission is granted on a per-event basis.

## REQUIRED STAFF

Volunteers, coaches, and instructors are vital to the success of a Multi-Gun Airsoft Experience. It takes a good team to accomplish a successful event—several people handling registration, managing logistics, and, of course, overseeing range operations. The operations staff (below) must include: The **airsoft volunteer** is needed to set up the range and also to help with cleanup after the event. Volunteers also assist in managing participants in and out of the range and oversee all non-shooting, non-instructional activities.

AIRSOFT ROLE	AGE	MINIMUM CERTIFICATIONS REQUIRED	HOW MANY
Volunteer	14+	None	As needed for the event
Coach	14+	Authorized by airsoft instructor	1 Per bay as authorized
Airsoft instructor	18+	NRA instructor or bsa national camping school shooting sports director or bsa bb-gun Rangemaster plus airsoft endorsement	1 Per bay

The **airsoft coach** should be present with the participant in the bay. Using the coach/pupil method, the coach must always remain behind or within arm's reach of the participant; this ensures that they can take immediate physical control of the airsoft gun from the participant if required. If a malfunction occurs, the participant must immediately cease fire and transfer control of the airsoft gun to the coach. Airsoft coaches—with the approval of the airsoft instructor—may reload airsoft guns.

The **airsoft instructor** is qualified in the safe use, care, and operation of airsoft pistols, rifles, and shotguns, and has been so endorsed. This endorsement is provided by the council hosting the airsoft event and is only good within that

council. The endorsement must be renewed anytime there is a change in the make/model of airsoft guns or a significant change in the operation of the Multi-Gun Experience format. The council Scout executive or their authorized delegate provides this endorsement. Any person applying for the endorsement must be at least a qualified BB-gun Rangemaster as defined in the *BSA National Shooting Sports Manual*; Appendix 5 provides the list of requirements. An airsoft instructor must conduct any required training before a participant can enter a bay with the airsoft coach.

The instructor may be appointed to sign off on all required documentation and applications to authorize the event. An instructor may serve as a coach. If no other coach is available, the instructor assumes the role.

## AIRSOFT RANGE LAYOUT

The BSA Multi-Gun Airsoft Experience is designed for an individual participant to shoot multiple guns, one at a time, at a given set of targets in a single bay. One or more bays, a waiting area, and an optional training area make up the complete airsoft range. Review Appendix 9 for a complete list of components that make up an airsoft range target bay.

## RANGE DESIGN

Each bay is designed to accommodate one participant and their coach in addition to the targets and airsoft guns with containers. It is recommended that you have a 10-foot-high backstop and ballistic cloth sidewalls on the right and left that connect with the backstop. The sidewalls must be at least 8 feet high to ensure the safety of others and structures surrounding the shooting area.

A safe minimum shooting distance (SMSD) of no less than 15 feet between airsoft guns and targets should be established to minimize the effects of ricochets to shooters, staff, and observers. This distance may be increased depending on the target materials in use and the velocity of the airsoft gun BBs. If multiple bays are used, they must be designed to prevent any risk of injury if someone is resetting targets downrange in an adjacent bay. These recommendations assume a maximum target height of 4.5 feet.

## SINGLE-BAY DESIGN

See Appendix 9 for a sample single-bay design in which pistol, rifle, and shotgun airsoft guns are used and there is a dedicated shooting lane for each type of gun. Each lane is set between the container for a particular gun and the targets intended to be shot by that gun.

All spectators must remain behind the control line. Up to five participants who are next in line may be positioned between the ready line and control line. Anyone

stepping forward of the control line must wear eye protection. Some type of highly visible and elevated barrier (e.g., rope or a fence) should be positioned at the control and side barriers with closable entrances as needed to manage entry into various areas of the range. Raised barriers with gates at the bay and ready lines are also suggested if you anticipate a lot of participants.

## MULTIPLE-BAY DESIGN

Appendix 10 shows a sample range with multiple bays. Note the suggested dedicated training area for first-time shooters and traffic flow. Each bay in a multi-bay range layout is operated independently of the others, and ballistic cloth sidewalls are required to prevent crossfire between the bays. Each bay must have its own instructor and shooting sequence. Once a participant is trained for a course of fire, repeat training at the same event is at the discretion of the instructor. Participants could be given wristbands or another indicator so they may be easily identified as “trained.” A separate training area may be established for single- or multiple-bay layouts.

An airsoft pistol, rifle, or shotgun is placed on the shooting table when a bay is ready for a course of fire. The gun must have the safety on and be pointing downrange. After shooting is completed, the gun must be placed in a container next to the shooting station; the ideal container is a plastic, non-marring barrel or trashcan where the guns are placed muzzle down. In the case of pistols it may be more appropriate to have a smaller container on a table. To help reduce damage, a soft cloth or pillow may be used in the container where the gun will be placed. If the muzzle cannot be placed in a down position it must be pointing downrange in a safe direction. Airsoft guns must have the safety engaged when in the container.

Obstacles within a bay are optional and provide a challenge as participants move from one shooting lane to another. If participants must go around an obstacle they must always go around the end farthest from the targets—toward the bay line. Participants must not cross over or under obstacles. Obstacles must not be taller than 4 feet above the ground to ensure there are no line-of-sight obstructions within the bay.

The backstop and walls should be constructed of material that will not allow airsoft BBs to penetrate them when fired from any distance.

Targets should be “responsive”—providing some sort of visual and/or audible indicator when struck. They can be made of materials to cause a sound (e.g., metal) or constructed so they will visibly move when hit. Moving or auto-resetting targets used for pellet guns or firearms usually will not work for airsoft because the BBs lack enough force to cause much movement.



## SELECTING AND BUILDING TARGETS

When planning your event, make sure that the targets selected are appropriate for the range layout and the equipment being used. A vendor list for commercially made targets is available in Appendix 6.

Questions to consider when choosing targets:

- What is the safe minimum shooting distance participants will be shooting from?
- How many shooters do you anticipate will attend?
- What is the specific type and style of airsoft gun that will be used? If you construct the targets instead of purchasing them from a vendor, any solid material will work—Plexiglas, sheet aluminum, and plywood are a few possibilities. Base your choice and the construction on the purpose each target will serve. If a target will be used multiple times, it should be easy to clean quickly between rounds. If you want it to fall on impact, the only requirement is that the target body be hinged at the base. Pay careful attention to the angle of the target to be sure that none of the airsoft BBs will travel back toward the firing line or outside the bay. Appendix 8 offers an example of how to build a simple sheet-metal target.

## PLANNING THE COURSE OF FIRE

An airsoft instructor should plan each *course of fire*—the sequence of actions that take place inside a bay. This sequence must include the start and end locations of the participant and coach as well as the shooting order of guns at each shooting lane and the number of shots per lane. To assist in this process, see Appendix 3 for a list of commonly used range commands and Appendix 9 for a single-bay range layout with three shooting lanes.

Typically, the participant and coach begin at the starting station as defined by the airsoft instructor who designed the course of fire. The instructor is in control of the bay and will provide commands to commence and cease fire. At the instructor's command the participant and coach will walk or run to the first shooting lane immediately behind the gun container. The participant then retrieves the airsoft gun from the table (always keeping the gun pointed in a safe direction), assumes a proper shooting stance, aims, disengages the safety, and proceeds to fire the prescribed number of shots at that station. The airsoft gun is then made safe and put back in the container. This sequence continues until all lanes have been visited or a "cease fire" command is given. When a participant and coach complete their last shooting lane, they go to the end station and await further instruction.

The airsoft coach remains immediately behind the participant at all times to ensure safe operation of each gun. The coach has the authority to call "cease fire" and to regain control of the gun. The coach is responsible

for reloading the gun if empty and helping participants if they have difficulty operating the gun action (e.g., cycling a pump shotgun). *At no time may a participant reload an airsoft gun.*

When planning the multi-gun course, remember that the sequence of gun formats (pistol, rifle, shotgun) can be in any order—as decided by the airsoft instructor—if you are using self-resetting targets. If the targets reset manually, the course of fire should move from bay to bay so targets can be reset in one bay while another is active. The setup of a course is at the discretion of the airsoft instructor and is only limited by the range being utilized.

## SHOPPING FOR AIRSOFT GUNS

When purchasing guns for the BSA Multi-Gun Airsoft Experience, consider the intended use, cocking force, and accuracy level, as well as how much you plan to spend. Remember that this is not a high-precision sport but, rather, it is intended for youth and novice shooters. You will want to make sure that the guns are affordable, reliable, and can withstand long periods of shooting. Do not be afraid to contact the manufacturers if you have specific questions.

BSA-approved airsoft guns are listed in Appendix 7. No other models are permitted. Your selections should be determined by the budget available, operating characteristics of the airsoft guns, and the number of expected participants (see table on next page).

This budget is only for one bay and does not include backstop, sidewalls, and other barrier materials. You will need to budget for miscellaneous items such as clipboards, shot timers or stopwatches, spray paint, eye protection, stakes and rope, trash cans and foam for placing empty guns at the end of a course of fire, tables, canopies, chairs, signage, and building supplies for barricades.

**Note:** By registering your Multi-Gun Airsoft Experience as an NRA Day Event, you can receive 50 T-shirts, 15 staff hats, gun safety rules cards, lapel pins, the *Winchester/NRA Marksmanship Qualification Program Book*, and as many participant and staff certificates as you need. The application fee is \$20.00. For more information visit <https://nraday.nra.org/Web/HostEvent.aspx> or call 1-800-672-7435, option 1.

## Sample minimum budget for a single shooting station

DESCRIPTION	PRICE	QTY	TOTAL COST
ICS CAT 002 CUSTOM RIFLE	\$199.95	1	\$199.95
KWA MARK III PISTOL GREEN GAS	\$164.95	1	\$164.95
UTG MULTI-SHOT COMBATTACTICAL SHOTGUN	\$59.90	1	\$59.90
<b>ACCESSORIES</b>			
KWA MARK III MAGAZINES – GREEN GAS	\$29.99	4	\$119.96
UTG MULTI-SHOT SHOTGUN SHELL CARTRIDGES (SIX PACK)	\$14.95	1	\$14.95
9.6V SPECIAL PURPOSE BATTERY FOR AIRSOFT RIFLE	\$24.95	1	\$24.95
KINGS ARMS 6MM PLASTIC BBS (5,000 ROUNDS)	\$19.99	1	\$19.99
KINGS ARMS GREEN GAS 8 OZ., 12 CT.	\$57.60	1	\$57.60
CUSTOMER-PROVIDED TARGETS FROM COMMONLY AVAILABLE MATERIALS	\$100.00	1	\$100.00
		<b>TOTAL</b>	<b>\$762.25</b>

### NRA FOUNDATION GRANTS

Consider applying for an NRA Foundation Grant to obtain different types of guns and support materials for your event.

The NRA Foundation is a 501(c)(3) tax-exempt organization that raises tax-deductible contributions to support qualified educational, training, and developmental programs. The *Friends of NRA* program raises money through dinners and auctions. Half of the monies raised are utilized by The NRA Foundation nationally, with the other half used for grants to qualified organizations in the state in which the money was raised. Each state has a *Friends of NRA* State Fund Committee that reviews grant applications and recommends grant funding to The NRA Foundation's board of trustees for final review. For more information about grants or to apply online, visit

<http://nrafoundation.org/apply-for-a-grant.aspx> or contact The NRA Foundation at (800) 423-6894.

### RELEASES

Advice from local legal counsel should be sought on the development of statements pertaining to event liability waivers, assumption of risk statements, and/or hold harmless agreements. Councils may wish to draft a document that contains both a parental statement for participants under 18–21 years of age, and a release, granting permission to use any pictures or video taken

during a BSA Multi-Gun Airsoft Experience event for advertising, promotion, or other purposes.

In the absence of specific local guidance, the [Activity Consent Form](#) can be utilized.

### EVENT PREPARATION

Establish well in advance the range layout and a list of volunteers and what they will be doing. Meet with all people who will serve in staff roles (airsoft instructors, coaches, etc.) and ensure they have adequate certification and training.

Be sure all airsoft guns are in working order and that backup guns are available. Have plenty of ammunition and supplies on hand. If new equipment or supplies must be purchased, ensure that vendors are contacted early to provide enough lead time for delivery, inspection, and any required training of staff.

Use the [BSA Event Checklist](#) to ensure all aspects of the event are considered.

The Program Hazard Analysis (PHA) Narrative and the PHA Matrix documents can be reviewed, discussed, and approved by the council's Enterprise Risk Management Committee.

Finally, advertise and market the Multi-Gun Airsoft Experience event and register with NRA's Recreational Shooting Department!

## APPENDIX 12.A

### GLOSSARY

**AIRSOFT GUNS.** Pneumatic gun replicas that function like real guns, used for training and recreation. They may be electric or powered by gas or spring action.

**AIM.** The process of aligning the gun with the target, usually by means of the sights.

**BACKSTOP.** A structure made to stop or collect the projectiles that hit it.

**BAY.** A square or rectangular area that is surrounded by two sidewalls and a backstop.

**BALLISTIC CLOTH.** A thick, tough, synthetic nylon fabric that is used to stop or slow down projectiles that hit it. Used as a backstop for airsoft.

**BARRICADE.** A structure or object for shooting from or behind. It may be used to aid or challenge the shooter's ability to make the shot.

**BERM.** A large pile of dirt on an outdoor shooting range that functions as a backstop.

**BOLT.** The mechanism in some guns that holds the cartridge in place during the firing process.

**CEASE FIRE.** To stop firing and remain in position. The muzzle must be pointed downrange with the finger removed from the trigger. The mechanical safety on each shooter's rifle is placed on "safe," the "cease fire" command is repeated to be sure all have heard it, and everyone waits for further instructions from the Range Safety Officer.

**CONTAINER.** A barrel, bucket, or other container that holds the airsoft gun when not in use.

**COURSE OF FIRE.** A predetermined instruction as to how and where the shots will be taken.

**DOWNRANGE.** The direction toward the target area of the range, where guns are pointed when they are fired.

**EXTERNAL SAFETY.** Accessible safety devices on the outer surface of a gun.

**FIRING LINE.** An imaginary or marked line from which shooters fire downrange. In an airsoft bay there may be separate firing lines for each gun station.

**LANE.** The shooting area between the airsoft gun and targets.

**MAGAZINE.** A device for holding ammunition ready for loading into the chamber of a repeating gun.

**MUZZLE.** The end of the barrel where the airsoft BB exits the gun.

**NO-SHOOT TARGET.** A downrange target that is painted red or black and should not be engaged. If a no-shoot target is shot it is a procedural penalty.

**RANGE IS COLD.** The phrase used when the firing line is safe and people may move freely about the range. Guns must not be handled when anyone is ahead of a lane firing line.

**RANGE IS HOT.** The phrase used when shooters are on the firing line preparing to shoot. Protection is worn and non-authorized persons must remain in the ready line behind the shooters.

**SAFE MINIMUM SHOOTING DISTANCE.** The smallest distance between target and airsoft gun to minimize the effects of ricochets to shooters, staff, and observers. For rifles, this distance is recommended to be no less than 20 feet. For pistols and shotguns, this distance should be no less than 15 feet.

**SELF-RESETTING TARGET.** A target designed with springs, weights, or wires so it will reset to the original stance after being shot.

**SEMI-AUTOMATIC.** A gun designed to fire shots and reload each time the trigger is pulled.

**SHOOTING PROTECTION.** Eye protection (mandatory) and ear protection (optional).

**STAGE.** A segment in an event program with its own course of fire, time limits, and target layout. Multiple stages may be incorporated into an event.

**STAND BY.** A command given to the shooter to wait with gun loaded and safety on. The command to start the course of fire will be given verbally or by a shot timer.

**TARGET ENGAGEMENT.** A specified sequence in which targets will be shot, usually set by the course of fire in the event program or by the event director.



## APPENDIX 12.B

### FREQUENTLY ASKED QUESTIONS

#### WHAT TYPES OF TARGETS ARE USED WITH AIRSOFT GUNS?

In the BSA program, airsoft guns may not be pointed at any living thing. Only paper, plastic, metal, or other suitable targets may be used. Care must be taken to ensure suitable backstops and targets must be arranged so there is no damage to nearby humans, animals, plants, or structures.

#### ARE FULLY AUTOMATIC AIRSOFT GUNS ALLOWED?

No. Fully automatic fire, shooting more than once per single pull of the trigger, is prohibited. If the airsoft gun has the ability to shoot in fully automatic and semi-automatic mode, only semiautomatic mode is permitted. Airsoft guns that are only fully automatic are prohibited. Please note airsoft shotguns that shoot multiple airsoft BBs per single pull of the trigger are not considered fully automatic.

#### WHAT MODELS OF AIRSOFT GUNS MAY BE PURCHASED OR USED BY BSA ORGANIZATIONS?

Appendix 12G lists by manufacturer and model the only airsoft guns and accessories permitted in the BSA. No other types are permitted regardless of similarity.

#### WHAT IS THE BAY?

An airsoft bay is a protected area or zone with multiple targets to accommodate one participant and one airsoft coach. Targets may be set up for each type of gun being shot in that bay. If multiple bays are used, each must be adequately secured so that participants and coaches can retrieve or reset their targets in other bays without risk of being hit by an airsoft BB.

#### IS SPECIAL SAFETY EQUIPMENT REQUIRED FOR AIRSOFT ACTIVITIES?

All people within a bay and everyone within the control area as determined by the instructor must wear adequate eye protection. Hearing protection is not required but may be worn by those sensitive to the noise of an airsoft gun. As with all Scouting activities, proper clothing including footwear must be worn at all times.

#### WHO MAY PARTICIPATE IN BSA MULTI-GUN AIRSOFT EXPERIENCE EVENTS SPONSORED BY COUNCILS AND DISTRICTS?

All participants must have a sufficient level of maturity and physical dexterity to safely operate an airsoft gun. The use of an airsoft pistol, rifle, or shotgun is left to the discretion of the airsoft instructor and council policies. All participants must receive training in the safe handling and operation of an airsoft gun before use. If they cannot demonstrate safe handling or operation they are not allowed to use the airsoft gun.

#### MAY UNITS CONDUCT A BSA MULTIGUN AIRSOFT EXPERIENCE EVENT?

Scouts BSA troops, Venturing crews, Sea Scout ships, and Exploring posts may conduct a full BSA Multi-Gun Airsoft Experience. Any unit conducting one of these events must have all required personnel as defined in this guide. The unit should get confirmation from its district executive and the council shooting sports committee before conducting any event involving airsoft guns. Permission is granted on a per-event basis.



## APPENDIX 12.C

### SAFETY BRIEFING

All participants must go through a safety briefing at the start of any BSA Multi-Gun Airsoft Experience. The briefing should be about five minutes long to avoid losing the participants' attention. Be sure to cover each of the five main areas in this NRA sample briefing:

#### 1. PURPOSE OF THE EVENT

Introduce yourself and the staff. Inform all shooters about the course of fire and emphasize that the event is for new and intermediate shooters.

#### 2. RANGE LAYOUT AND LIMITS

- Explain the range setup and point out where the spectator area is located. There should also be a holding area where participants can wait for their turn to shoot.
- Show the participants which targets are designated for each gun they are shooting.

#### 3. SAFETY RULES AND SITE SPECIFIC RULES

- Demonstrate how to operate each airsoft gun.
- **ALWAYS** keep the gun pointed in a safe direction.
- **ALWAYS** keep your finger off the trigger until ready to shoot.
- **ALWAYS** keep the gun unloaded until ready to use.
- Cover site-specific rules as needed.

#### 4. FIRING LINE COMMANDS

Firing commands must be simple and clear. Ensure that all participants know and understand what is meant and what is expected of them. Depending on the range environment, make use of a loud speaker system to clearly communicate with those on the firing line. A possible firing command sequence might proceed as follows:

- A. "Range is hot."
- B. "Shooter, do you understand the course of shooting?" (Answers yes or no.)
- C. "Make ready."
- D. "Are you ready?" (Yes or no.)
- E. "Shooter indicates they are ready."
- F. "Stand by."
- G. "Start" or timer tone.
- H. Stage ends when last shot fired.
- I. "Time."
- J. Time is read from timer.
- K. "Range is cold."
- L. Command to staff only: "Reset stage."

#### 5. EMERGENCY COMMANDS AND PROCEDURES

"Stop."

"Cease fire."

In the event of an emergency, all shooting must cease. All staff must be aware of the emergency plan.

## APPENDIX 12.D

### FIRST AID AND EMERGENCY PLANNING

No one wants an injury or emergency to occur during an event, so preparation is crucial. If your range does not have a first-aid kit, one should be purchased and placed in a central location accessible to everyone. You may also set up a designated first-aid station or ask a local rescue squad to have a trained paramedic at your event if none of your instructors or volunteers are certified in first aid and CPR.

You may have an emergency plan already in place, but if not, all staff and volunteers should review the steps for responding to an emergency. Be sure they all know the location of the first-aid kit or the people responsible for administering first aid.

Establish procedures to be followed in case of an emergency:

- Take charge of the situation.
- Call for help, if required.
- Render aid within your scope of training.
- Direct responders to the location.
- Take notes for a report.



## APPENDIX 12.E

### AIRSOFT ENDORSEMENT

A person is entitled to an airsoft endorsement by their council if they demonstrate the following to the council shooting sports director or their authorized representative.

- Present a current BSA BB-Gun Rangemaster certification or any NRA instructor certification. An NRA Range Safety Officer certification is not sufficient because this is not equivalent to an NRA instructor rating.
- Know and explain the three Fundamental Rules for Safe Gun Handling.
- Know and explain the fundamental operation of battery-, gas-, and spring-powered airsoft guns.
- For each BSA-approved airsoft gun type demonstrate the following:
  - How to put the gun on “safe” and take it off
  - How batteries are changed in an electric gun
  - How a gas-powered gun is recharged
  - How to cycle the action of a spring-powered gun
  - How to load airsoft BBs into the gun
  - How to unload the BBs if the gun is already loaded
  - The proper holding of an airsoft gun
  - The proper airsoft shooting position while standing
  - How to aim and fire an airsoft gun (requires a safe location). A full range of gun formats is not required.
  - How to change magazines and cartridges (e.g., multi-BB shotgun shells, CO2 gas) if so equipped
- Explain a typical airsoft bay layout and the importance of each component.
- Explain targets that are suitable for different types of airsoft guns.
- Explain airsoft BBs.
- Explain the different airsoft roles:
  - Participant
  - Coach
  - Instructor
- Demonstrate in a simulated shooting environment how an airsoft coach and participant would conduct a course of fire in a typical Multi-Gun Airsoft Experience.
- Explain or demonstrate when it is necessary to take physical control of an airsoft gun from the participant.

The airsoft endorsement, once earned, is valid for two years. An endorsement card (No. 33767/SKU 615012) shall be issued and signed by the council shooting sports director or their authorized representative. The training code is S100/Multi-Gun Airsoft Training.

## APPENDIX 12.F

### APPROVED VENDORS

#### AIRSOFT SUPPLIERS

##### AIRSOFT GI

1077 Commerce Pointe Drive  
Walnut, CA 91789  
Company phone 909-869-0671  
Website: [www.airsoftgi.com](http://www.airsoftgi.com)  
BSA liaison: Ed Gatti, 804-909-7380;  
[edwardg@airsoftgi.com](mailto:edwardg@airsoftgi.com) or Frank Chu, 909-869-0671,  
[manager@airsoftgi.com](mailto:manager@airsoftgi.com)

##### AIRSOFT MEGASTORE

100 N. Providence Road, Unit A  
Chesterfield, VA 23235  
Phone: 818-495-6502  
Email: [support@airsoftmegastore.com](mailto:support@airsoftmegastore.com)  
Website: [www.airsoftmegastore.com](http://www.airsoftmegastore.com)

##### PYRAMYD AIR

5135 Naiman Parkway  
Solon, OH 44139  
Phone: 888-262-4867  
Fax: 216-896-0896  
Email: [sales@pyramydair.com](mailto:sales@pyramydair.com)  
Website: [www.pyramydair.com](http://www.pyramydair.com)

##### C.A.T. COMMAND AIRSOFT TECHNOLOGIES

125 Wes Walker Memorial Drive  
Ball Ground, GA 30107  
Phone: 770-704-7949  
Fax: 770-720-7861  
Email: [sales@catairsoft.com](mailto:sales@catairsoft.com)

##### CROSMAN

7629 Routes 5 & 20  
Bloomfield, NY 14469  
Phone: 1-800-7AIRGUN (724-7486)  
Website: [www.crosman.com](http://www.crosman.com)

### TARGET MANUFACTURERS

#### TACTRAINERS

2012 Downrange Blvd.  
Fresno, CA 93720  
Phone: 559-451-1132  
Email: [instructor@tactrainers.com](mailto:instructor@tactrainers.com)  
Website: [www.tactrainers.com](http://www.tactrainers.com)

## APPENDIX 12.G

### PERMITTED AIRSOFT GUNS AND ACCESSORIES

<b>AIRSOFT PISTOLS</b>
ELITE FORCE FULL METAL 1911A1 CO2 BLOWBACK PISTOL
ELITE FORCE WALTHER PPQ MOD 2 GBB PISTOL
KWA MARK III PISTOL GREEN GAS (NRA SUGGESTED)
<b>AIRSOFT SHOTGUNS</b>
BRAVO 3 BURST FULL STOCK SHOTGUN SPRING AIRSOFT GUN
TOKYO MARUI M870 FULL METAL GAS TACTICAL POLICE SHOTGUN
UTG MULTI-SHOT COMBATTACTICAL SHOTGUN (NRA SUGGESTED)
<b>AIRSOFT RIFLES</b>
COMBAT MACHINE M16 CARBINE AEG AIRSOFT GUN
TOKYO MARUI M870 FULL METAL GAS TACTICAL POLICE SHOTGUN
KRYTAC FULL METAL TRIDENT M4 SPR KEYMOD
ICS CAT 002 CUSTOM RIFLE (NRA SUGGESTED)
<b>AIRSOFT BOLT ACTION RIFLES</b>
CUSTOM FN HERSTAL SPR A5M SNIPER RIFLE AIRSOFT
CUSTOM JG BAR 10
<b>ACCESSORIES</b>
BRAVO 30RD M3/M56 SPRING-POWERED SHOTGUN SHELL PACKAGE
ELITE FORCE M4/M16 140RD MID-CAP BLACK (10 PACK)
TENERGY 9.6V 1600MAH NIMH CRANE STOCK BATTERY
KWA .20G 4000 BBS
D POWER UNIVERSAL SMART CHARGER
GREEN GAS (12 PER CASE)
KWA MARK III MAGAZINES – GREEN GAS (NRA SUGGESTED)
UTG M3 MULTI-SHOT SHOTGUN SHELL CARTRIDGES (SIX PACK) (NRA SUGGESTED)

## APPENDIX 12.H

### SAMPLE AIRSOFT TARGET CONSTRUCTION

The targets for the BSA Multi-Gun Airsoft Experience can be simple yet effective in construction. This example consists mainly of 1¼-inch PVC components and a simple sheet-metal target that can be cut at any local metal shop. Targets may be constructed in 2-, 3-, or 4-foot heights. The metal target face can be cut in three uniform sizes: 3-inch circle, 4-inch circle, or a 4½× 6-inch rectangle; the sizes are modeled to scale to simulate the sight picture of current NRA 3 Gun Experience or Steel Challenge targets. Each target should be cut with a 1" × 1" square tab on the perimeter that can bend at a 90-degree angle for mounting to the main beam of the target stand.

ITEM	QTY	PRICE
1¼" X 10' SCHEDULE 40 PVC PIPE	1	\$5.00
1¼" FIVE-WAY PVC FURNITURE FITTING	1	\$3.10
1¼" PVC CAP	5	\$3.00
* 16-GAUGE STEEL TARGET	1	\$2.40
4" METAL BAR	1	MIN
NUT/SCREW	2	MIN
NUT/BOLT	1	MIN
<b>TOTAL PER TARGET</b>		<b>\$25.50</b>

\*The 16-gauge steel targets can be manufactured at any local metal fabrication shop in three uniformed sizes (3" circle, 4" circle and 4½" x 6" rectangle). The sizes are modeled to scale to simulate the same sight picture of current NRA 3 Gun Experience or Steel Challenge targets.

1. Cut a 4-foot piece from the PVC pipe to serve as the main target beam.
2. Cut four 1-foot pieces of PVC and place a cap on one end of each piece.

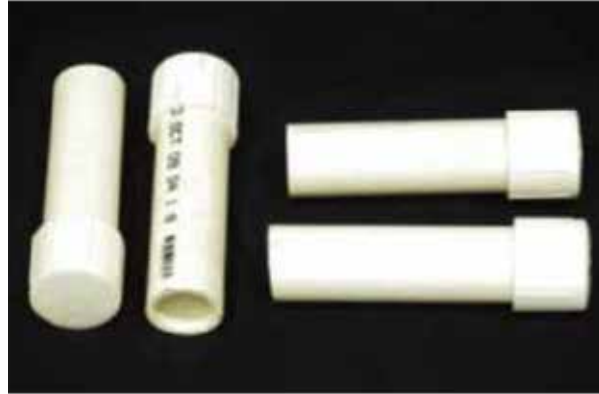

3. Place the four capped pieces inside the four perpendicular openings of the PVC furniture fitting.

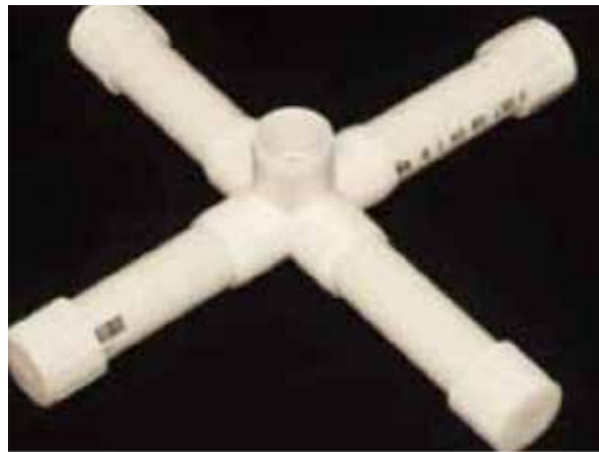



4. Insert the main target beam into the remaining opening of the five-way connector. You can add weight for stability by filling the bottom of the stand with sand or other material. If even more stability is required, put the base in a large planter pot and then fill the pot with sand or gravel.

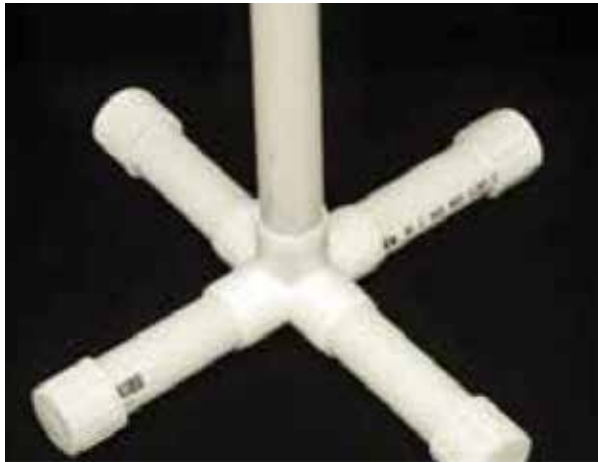

5. To attach the target face, start by drilling two holes into the bent 1" x 1" tab. Then drill two corresponding holes into the 4-inch metal bar and affix the target to the bar with two screws secured by nuts. It is **IMPORTANT** not to tighten the nuts against the target: Leaving the nuts loose will allow the target to tilt backward when it is hit. Then the BBs travel downward, preventing them from ricocheting back to the firing line. A dab of metal adhesive such as Loctite will prevent the screw from backing too far off during use.



6. Drill a hole in the opposite end of the metal bar and secure it to the remaining PVC cap with a nut and bolt.



7. Attach the PVC cap to the main beam to complete the target construction.







# APPENDIX 12.J

## SAMPLE RANGE LAYOUT (MULTI-BAY)

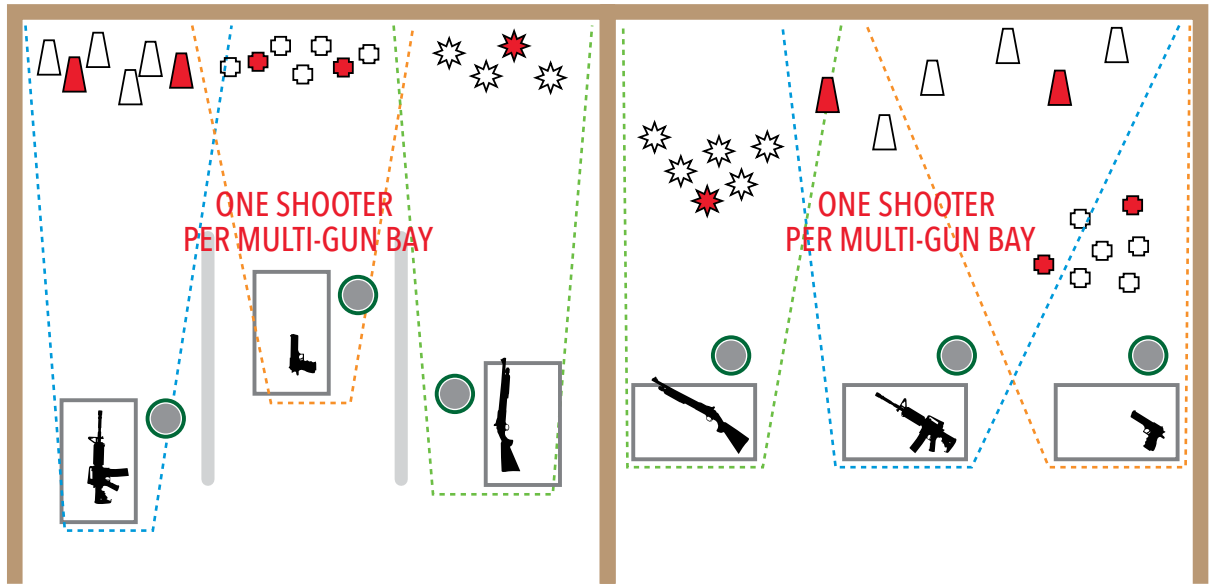

ENTRANCE



EXIT

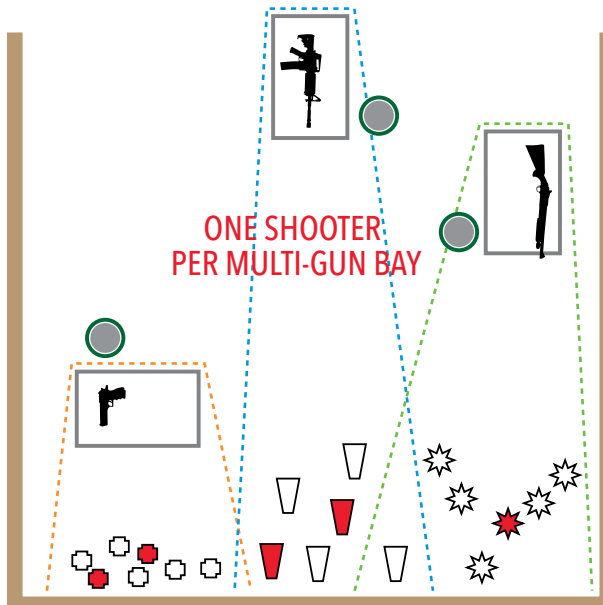

<b>RIFLE</b>	<b>SHOTGUN</b>	<b>PISTOL</b>
<b>FIRING LANE</b>	<b>FIRING LANE</b>	<b>FIRING LANE</b>
TARGET	TARGET	TARGET
"NO SHOOT"	"NO SHOOT"	"NO SHOOT"
OBSTACLE	TABLE	TRASHCAN/ BARREL
WALL/BERM		

All spectators must be behind control line.  
Targets and stands should be oriented to minimize ricochets.

Guns should be no closer than 15 feet to the target.

# APPENDIX 13 - CHALK BALL PROGRAM GUIDE

## CONTENTS

- 155 **INTRODUCTION**
- 155 Youth Requirements
- 155 Adult Supervision and Training Requirements
- 155 Program Guidelines
- 155 Standard Operating Procedures
- 157 Sample Budget
- 158 **APPENDIXES**
- 158 Appendix 13a: Sample Range Safety Rules
- 159 Appendix 13b: Chalk Ball Venues
- 161 Appendix 13c: Sample Chalk Ball Course Inspection Checklist
- 161 Appendix 13d: Chalk Ball Course Safety Briefing

## INTRODUCTION

This guide is intended to provide councils and districts with an overview of the requirements for running the chalk ball program. This is not a unit-level activity and must not be conducted as one. In this publication, you will find youth requirements, training requirements for adults who are providing the program, and sample budgets for running this program in camp and weekend program venues. The appendix contains plans for building the facilities for the program area.

The chalk ball program is intended to provide a special and unique experience for Scouts BSA and Venturers who are attending summer camp or weekend programming. Scouts will have an opportunity to shoot chalk ball markers at various targets. Youth are given 100 chalk/paint balls and move through a course with specific rules regarding safe handling of the markers and operational equipment. The goal of the program is to teach safe handling, responsibility, and marksmanship through a fun activity. **Either chalk balls and paintballs may be used for this program.**

This program does not use the LaPorte throwing system and should not be confused with the flashball program that uses LaPorte equipment.



## YOUTH REQUIREMENTS

This program is for youth in the Scouts BSA program. Youth in the Venturing program may also participate. Cub Scout-age youth are not allowed to participate.

## ADULT SUPERVISION AND TRAINING REQUIREMENTS

BSA Youth Protection policies for two-deep leadership must be maintained at all times. All course personnel involved in the chalk ball shooting program are required to have current certifications and ratings in the roles they will be performing on the course at that time.

An NRA Range Safety Officer (RSO) is in charge of the entire field and will conduct the safety briefing and give range calls as required.

## PROGRAM GUIDELINES

### APPLICABLE LAWS

BSA safety policies generally run parallel to or go beyond legal mandates. However, it is the camp or activity supervisor's responsibility to confirm and ensure compliance with all applicable federal, state, and local regulations or statutes related to youth handling and using a paintball marking gun.

### BSA GUIDELINES

This is a Level 2 shooting sports activity and must follow all guidelines in the *Boy Scouts of America National Shooting Sports Manual*, No. 430-938. Visit <https://www.scouting.org/outdoor-programs/shooting-sports/>.

### STANDARD OPERATING PROCEDURES

Before beginning this program, a program hazard analysis should be conducted for the range and this program as outlined in National Camp Accreditation Program standard PD-111 ([www.scouting.org/ncap](http://www.scouting.org/ncap)). The enterprise risk management committee for the council should review the analysis as per standard PD-112. The program hazard analysis instructions and template can be found at <https://www.scouting.org/health-and-safety/forms/>.

Your range Standard Operating Procedures should also be reviewed and updated to reflect the requirements for delivering this program. A template for range standard operating procedures is located in Appendix 3 of the *BSA National Shooting Sports Manual* if you do not already have them for your range.

## **RUNNING THE PROGRAM**

The chalk ball course is made up of aluminum horizontal spinning targets, vertical spinning targets, and cowbells. The range has shooting positions with significant separation between each position. Two shooters shoot at separate and parallel targets at a time. (See the appendix for a recommended layout of a chalk ball course.)

The chalk ball course is a series of targets presented in differing distances and types of targets, allowing the shooter to test their skills at differing sight pictures.

The shooting course has shooting positions capable of handling two shooters at a time. The range has signage and barriers, allowing containment of shoots, and it bars unauthorized people from entering the shooting area.

### **RANGE EQUIPMENT LIST**

- Four paintball markers
- 15 plastic chalk ball containers
- 16 masks
- 10 metal targets
- One radio
- Six cowbell targets
- Two carrying boxes for markers
- One first-aid kit
- Two 50-pound CO<sub>2</sub> cylinders
- Eight 20-ounce CO<sub>2</sub> canisters

## **BEFORE YOUTH ARRIVE AT THE PROGRAM AREA**

- All markers, ammunition, and targets are provisioned during nonprogram times by maintenance and support personnel in sufficient quantity to run the program for all shooters without interruption.
- Face masks and goggles should be cleaned between each shooter.
- Range staff will assist the RSO by putting up targets, preparing markers, staging chalk/paint balls to the preparation table, and setting up shooting positions along the course.
- General staging areas for shooters and those waiting their turn are clearly marked and include a well-defined path along the course so shooters and range staff can easily travel, carrying the markers and maintaining safe gun-handling rules.

## **WHEN YOUTH ARE PRESENT IN THE PROGRAM AREA**

- Welcome youth to the area and begin the chalk ball safety briefing found in Appendix 4 of this guide.
- Each shooter will be accompanied by range staff, who will be actively involved in every shot and all marker handling.
- Range staff members are responsible for the adherence to safety rules and commands provided by the range safety officer at ALL TIMES. They will oversee the shooting, sighting, and exception situations (such as cease-fires) on the course for the shooter.
- Range staff members carry the markers between each set of shooting positions. Markers are kept on safety and pointed downrange at all times. Between shooting stations, markers are carried in a box by the range staff.
- At the first shooting position, youth load the hoppers using a plastic container of chalk/paint balls they were given during the safety briefing. Give instructions that this is enough “ammo” to have a number of shots at each target.

## SAMPLE BUDGET

Sample startup/one-year budget for chalk ball program. Costs may vary by council depending on the range setup and the number of youth taking part in the program.

ONE-TIME STARTUP COSTS	PRICE	QTY	TOTAL COST
TIPPMANN 98 CUSTOM ULTRA PS PAINTBALL MARKER GUN, BLACK	\$119	4	\$476
3SKULL PAINTBALL CO <sub>2</sub> OR COMPRESSED AIR, ALUMINUM TANK WITH PIN VALVE LIME, 20 OUNCES	\$15	8	\$120
EMPIRE PE BASIC 48CI 3000PSI HPA NITRO N2 PAINTBALL TANK, BLACK	\$39	8	\$312
GXG PAINTBALL XVSN GOGGLE MASK, BLACK	\$14.95	16	\$239.20
3SKULL PAINTBALL PREMIUM 200 ROUND HOPPER, BLACK (SKU 49427146)	\$4.95	8	\$39.60
METAL TARGETS			\$600
COWBELLS	\$12.50	6	\$75
		<b>TOTAL</b>	<b>\$1,861.80</b>
<b>ONGOING YEARLY ESTIMATED COSTS (PER 100 SHOOTERS)</b>			
<b>.50 CALIBER</b> CHALK/PAINT BALLS (PER SHOOTER) Note: paint balls are much less expensive		100	\$500
CANISTER FILLS (PER SHOOTER)		32	\$160
		<b>TOTAL</b>	<b>\$660</b>

If you have questions or would like additional information about this program, email [shootingsports@Scouting.org](mailto:shootingsports@Scouting.org)

## APPENDIX 13.A

### SAMPLE RANGE SAFETY RULES

The chalk ball range rules governing marker safety are listed below.

- **ALWAYS** keep the marker pointed downrange.
- **ALWAYS** keep your finger off the trigger until ready to shoot.
- **ALWAYS** keep the marker unloaded until ready to use.

In addition to those rules, there is a set of guidelines necessary for the safe operation of the course:

- The course should NEVER be opened without a working radio or alternate working communications device on the premises.
- A first-aid kit that is well-stocked and in good repair will be available in a public location for everyone to see and use.
- Storage of markers and chalk/paint balls will be in separate lockable cabinets. The keys and combinations for those cabinets will be under the control of the course operations range staff.
- The course must be walked one time per day to establish that the perimeter is safe and that the safety signs are still in place.
- All markers and chalk/paint balls will be secured before personnel leave the course for any reason.
- The filling of canisters is to be performed only by a competent adult familiar with the process. Heavy gloves and eye protection are to be worn at all times while filling canisters.
- Range staff members are the only personnel allowed on the firing line of the course with the shooters, unless the range safety officer gives specific permission.
- All shooters must wear eye protection at all times while on the course.
- During any CEASE-FIRE, all firing positions will stop shooting, put their marker on safety, keep the muzzle pointed downrange, and wait for additional instructions.
- At no time should the muzzle of any marker be pointed above the berm.
- Targets are of various types (spinning and stationary) and are intended to give varying “sight pictures” to our Scouts.
- Any ammunition dropped on the ground or found on the ground should be left there.
- When the marker runs out of chalk/paint balls, the shooter is done, no matter how far along the course they may be.
- No food or drink is allowed on the course.
- The use of tobacco and alcohol products is forbidden on the course.
- In the event of a health or safety emergency, the Range Safety Officer is responsible for managing the event. If they are not able to do so, the lead range staff member will be responsible.
- In the event of a health issue, contact reservation headquarters personnel via radio, and they will direct your actions from that point until resolution.
- Unruly behavior and unsafe actions will result in a warning from the range staff. In the event of repeated misbehavior, the range staff may at their discretion remove the shooter from the course for the day. No refunds of fees are necessary in the event of a removal from the course.
- In the event of a Scout being shot with a chalk/paint ball, the shooter and the “hitee” are banned from the course for the remainder of the program.
- At any time that thunder is heard or lightning is seen, the course must be shut down and no shooting will occur until 30 minutes after such observation is made.
- Only shooters and course personnel are allowed on the firing line during a firing sequence without specific permission from the range staff.

# APPENDIX 13.B

## CHALK BALL VENUES

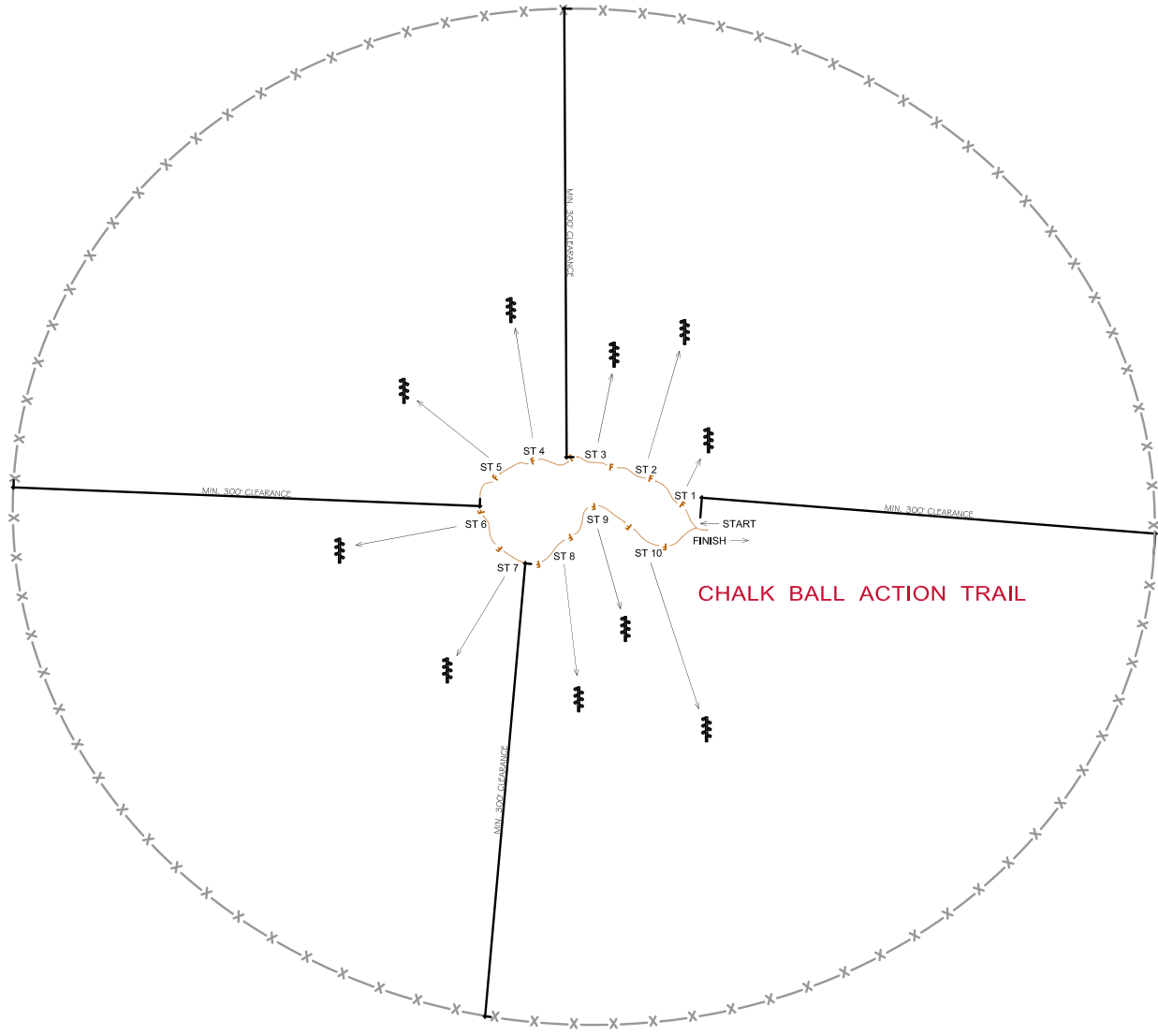

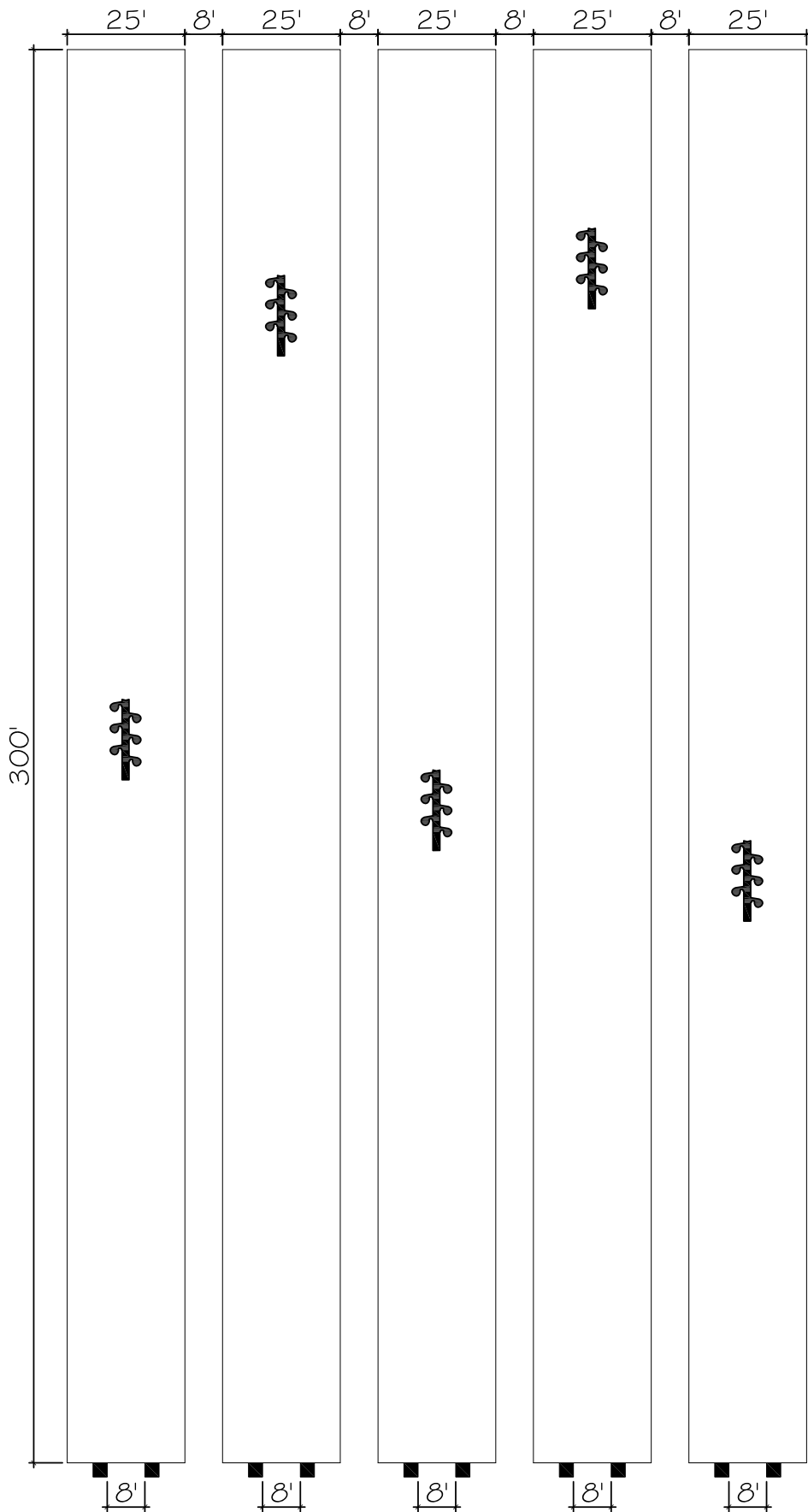

**CHALK BALL RANGE**



## APPENDIX 13.C

### SAMPLE CHALK BALL COURSE INSPECTION CHECKLIST

Inspected by \_\_\_\_\_ Date \_\_\_\_\_

√ = Yes

- Controlled access/fencing/gates closed
- Flags or signs displayed
- Left and right range limits displayed
- Backstop/impact area inspected
- Lumber boards painted and visible
- Target frames/mounts in good repair
- Ready line/area marked
- Spectator area designated
- Scoring area established
- Supplies available
- Range staff control area centralized
- System/bullhorn working
- First-aid kit filled/accessible
- Course rules posted
- Bulletin board hung
- Marker racks available
- Empty trash receptacles available
- Storage lockable

## APPENDIX 13.D

### CHALK BALL COURSE SAFETY BRIEFING

#### GENERAL

- Explain that the shooting device is a paintball “marker,” not a paintball “gun.”
- Go over the basic components of the marker: hopper, CO<sub>2</sub> canister, and sights.
- Explain that chalk/paint balls are loaded into the hopper.
- Describe the chalk/paint balls. They have a hard, waxy exterior with powder inside and dimpling on the outside. State that any chalk/paint balls on the ground must be left there because they may have already been shot and weakened.
- Point out that CO<sub>2</sub> is the propellant, the tank may get cold while shooting, and the tanks may need to be switched out during shooting.
- Explain that the sight is a basic iron sight. Adjust aiming based on the last shot because the sight is not adjustable.
- Clearly state that the mechanical safety must be on at all times unless the marker is aimed downrange and ready to shoot. Black means the safety is engaged; red means that the safety is off. Do not rely solely on the safety. Keep the barrel pointed at the ground or downrange at all times. Do not point the marker at anything not downrange or at anyone. Keep your finger off the trigger until ready to shoot.
- Pass out eye protection, which should be worn at all times on the course, even when not shooting.
- Take any questions.

## QUALIFICATIONS

When markers are used during the briefing, the Range Safety Officer must follow the NRA gun safety rules.

### 1. PURPOSE OF THE SHOOTING EVENT

- Tell participants that they will engage in chalk/paint ball shooting on the course.
- Explain that each marker will be loaded with 100 chalk/paint balls.
- Demonstrate the safe loading and unloading of each marker they will use.
- Each participant will shoot a total of 100 chalk/paint balls. Instruct them to shoot short bursts at each target and conserve the chalk/paint balls so they can hit each target.
- Range staff will be at each shooting station to provide guidance and instruction. The role of range staff and the RSO is to provide a safe environment for the shoot.

### 2. COURSE LAYOUT AND LIMITS

- Point out and describe the course layout and explain what stations will be used and which markers will be shot at each station.
- Describe the firing line for each target and explain what the purpose is. Explain when shooters are expected to be at each line.
- Spectators are not allowed on the course and should remain in the staging area until the Scouts return from shooting.

### 3. COURSE SAFETY RULES

Three fundamental NRA rules for safe marker handling:

Ask: What is the first rule of safe marker handling?

—Always keep the marker pointed in a safe direction.

Ask: What does a “safe direction” mean?

—The marker is pointed so that even if it were to go off, it would not cause injury.

Ask: What is the second rule of safe marker handling?

—Always keep your finger off the trigger until ready to shoot.

Ask: Unless shooting, where should the shooter’s finger(s) rest?

—The finger(s) should rest alongside the marker, i.e., on the frame, receiver, or trigger guard.

Ask: What is the third rule of safe marker handling?

—Always keep the marker unloaded until ready to use.

Emphasize that safeties can fail. Safe marker handling rules should be followed all the time!

## Rules for safe use

*Know your target and what is beyond.*

Ask: What is meant by “know your target and what is beyond”?

—The shooter must be sure that projectiles will safely hit the backstop.

*Be sure the marker is safe to operate. Know how to use the marker safely.*

Ask: What is meant by “know how to use the marker safely”?

—Shooters need to know how the marker operates, its basic parts, how to safely open and close the action, and how to remove ammunition.

*Use only the correct ammunition for your marker.*

Ask: What is meant by “use only the correct ammunition”?

—Only ammunition designed for a particular marker can be safely fired in that marker  
—Shooters should ensure that the chalk ball/paintball matches the marker size.

**.50 caliber balls only.**

*Wear eye protection as appropriate.*

Ask: Why should course users wear eye protection?

—Markers can also emit debris, gas, and broken chalk balls that could cause eye injuries.

*Never use alcohol or drugs before or while shooting.*

Ask: What type of substance is implied by “never use alcohol or drugs”?

—It refers to any substance that may impair normal mental or physical bodily functions.

## General course safety rules

Ask course users to read rules as you (range staff) point to course posters or refer to handouts.

—Know and obey all course commands.

—Know where others are at all times.

—Shoot only at authorized targets.

—Do not handle a marker while others are downrange.

—Stop shooting immediately upon the command of “cease firing.”

Ask: Why is it important to shoot only at authorized targets?

—Shooting at different targets, e.g., steel targets, at different distances or angles may result in hazardous conditions.

Ask: What actions should shooters perform during a cease-fire?

—Stop shooting immediately.

—Await further instructions from the range staff.

## **NRA hygiene guidelines**

- —Wash your hands and face with cold water after leaving the course or cleaning area before eating or drinking.

Ask: Why are shooters required to leave dropped ammunition on the ground?

- —This policy prevents shooters from unintentionally pointing the marker at other users while retrieving dropped ammunition, or inadvertently moving in front of the firing line.

## **4. FIRING LINE COMMANDS**

State and explain standard course commands that will be used for chalk ball:

- —“Commence firing!” signals shooters to begin shooting.

- —“Cease firing!” notifies shooters to stop firing immediately and wait for further instructions.

Ask: Who can call a cease-fire?

- —Anyone on the range who sees something unsafe.

- —“Course is clear” means all markers are benched.

## **5. EMERGENCY PROCEDURES**

- Take charge of the situation. (Determine the seriousness of an injury and assign duties.)
- Render aid. A first-aid kit should be centrally located.
- Call for help via radio.
- Direct help to your location.



# APPENDIX 14 - COWBOY ACTION SHOOTING PROGRAM GUIDE

## CONTENTS

165	<b>INTRODUCTION</b>
165	Youth Requirements
165	Adult Supervision and Training Requirements
166	Program Guidelines
166	Standard Operating Procedures
167	Running the Program
168	Sample Budget
169	<b>APPENDIXES</b>
169	Appendix 14a: Permission Form
170	Appendix 14b: Range Designs
173	Appendix 14c: Sample Cowboy Action Range Inspection Checklist
174	Appendix 14d: Sample Cowboy Action Shooting Scenarios
175	Appendix 14e: Cowboy Action Shooting Safety Briefing

## INTRODUCTION

This guide is intended to provide councils and districts with an overview of the requirements for running the Cowboy action shooting program. This is not a unit-level activity, and it should not be conducted as one. In this publication you will find youth requirements, training requirements for adults who are providing the program, and sample budgets for camp and weekend program venues. Plans for building the program area facilities are included in the appendix.

The program offers a fun and safe introduction to Cowboy action shooting with pistols, rifles, and shotguns. While attending camp, Scouts BSA and Venturers 14 years of age or older can take part in a special shooting experience with opportunities to shoot single-action .22-caliber pistols, lever-action .22-caliber rifles, and 12-gauge or 20-gauge shotguns.

In various old-time western scenarios, Scouts play “good guys” who prove their accuracy by shooting at things like spinning metal targets where they hit the spinner to “ring the bell.” All shooters choose their own Cowboy action names before starting so the NRA instructors—dressed in cowboy attire—can call them by those names.

## YOUTH REQUIREMENTS

Scouts BSA and Venturers who are over the age of 14, or are 13 and have completed the eighth grade, may participate in this activity.

All youth participants are required to have written permission from their parent or guardian before they can take part in the program. A sample permission form is included in Appendix 1 of this guide. The council may also include this as part of the overall permissions for the camp or activity; however, it must clearly state that a child has the parent or guardian’s permission to handle and fire a handgun, rifle, and shotgun.

## ADULT SUPERVISION AND TRAINING REQUIREMENTS

BSA Youth Protection policies for two-deep leadership must be maintained at all times.

The Cowboy action shooting program can be conducted only by NRA-certified instructors with pistol, rifle, and/or shotgun certifications (must have all three if using all three types of firearms). Each Cowboy action shooting participant will be accompanied by a certified pistol, rifle, or shotgun instructor (depending on the firearm being used) who is actively involved in every shot and all of the gun handling. All Range Safety Officers and instructors for this program must possess current credentials for the discipline they will be instructing.

- Range Safety Officers (RSOs) must have current certification from the NRA.
- Instructors must have a current rating of pistol, rifle, or shotgun instructor from the NRA.



## PROGRAM GUIDELINES

### APPLICABLE LAWS

BSA safety policies generally run parallel to or go beyond legal mandates. However, it is the camp or activity supervisor's responsibility to confirm and ensure compliance with all applicable federal, state, and local regulations or statutes related to youth handling and using a firearm.

### BSA GUIDELINES

This is an "open shooting experience," or level 2 according to the five levels of BSA shooting activities. All guidelines in the Boy Scouts of America National Shooting Sports Manual, No. 430-938, must be followed ([http://www.scouting.org/filestore/Outdoor%20Program/pdf/30931\\_WB.pdf](http://www.scouting.org/filestore/Outdoor%20Program/pdf/30931_WB.pdf)).

Lever-action rifles have been approved for use in this program only and should not be used in other Scouting programs.

## STANDARD OPERATING PROCEDURES

Before beginning this program, a program hazard analysis should be conducted for the range and this program as outlined in National Camp Accreditation Program standard PD-111 ([www.scouting.org/ncap](http://www.scouting.org/ncap)). The enterprise risk management committee for the council should review the analysis as per standard PD-112. The program hazard analysis instructions and template can be found at [www.scouting.org/HealthandSafety/Forms](http://www.scouting.org/HealthandSafety/Forms).

The standard operating procedures (SOPs) of the range should also be reviewed and updated to reflect the requirements for delivering this program. A range SOP sample can be found in Appendix 3 of the BSA National Shooting Sports Manual.

### RANGE DESIGN

This program is intended to give youth an Old West "cowboy" shooting experience. The range should be specifically designed to provide the Old West look and feel. Range designs can be found in Appendix 2 of this guide.



**3D VIEW - FRONT**  
NO SCALE

### COWBOY ACTION SHOOTING PAVILION



**3D VIEW - REAR**  
NO SCALE



## **RUNNING THE PROGRAM**

### **BEFORE YOUTH ARRIVE**

The program provides a fun immersion in old-time shooting scenarios where youth take on the persona of the “good guy,” shooting at targets to prove their shooting accuracy. Sample scenarios are in Appendix 3 of this guide. You can adapt these samples for your camp or come up with your own scenarios that relate to the history of your area.

If metal targets are used, ensure that the targets are properly angled and at a proper distance so that all metal splatter hits the ground away from participants and instructors.

All firearms, ammunition, and targets are set up during non-program hours by maintenance personnel in sufficient quantity to run the program for all shooters without interruption. Only council-maintained firearms and ammunition should be used for this program.

Instructors will assist the NRA Range Safety Officer in putting up targets, placing firearms on the firing line, staging ammunition on the preparation table, and setting up shooting positions and Cowboy action scenery.

General staging areas for shooters and those waiting their turn are clearly marked and include a red “ready” line behind each shooting position. As shooters enter, they stand behind the line and await the command to move to the shooting position.

### **WHILE YOUTH ARE IN THE ACTIVITY AREA**

- Each shooter in the Cowboy action shooting program will have a certified pistol, rifle, or shotgun instructor, depending on the shooting position. The instructor will be actively involved in every shot and all of the gun handling at that station. Qualified instructors should be stationed at each position prior to youth beginning the shooting experience.
- The pistol, rifle, or shotgun will be loaded by the instructor prior to the shooter arriving at the shooting position.
- Instructors are responsible for adhering at ALL TIMES to safety rules and the commands provided by the NRA Range Safety Officer.
- Each instructor will oversee their shooter’s unloading, shooting, and sighting on the range, as well as exceptional situations such as cease-fires.
- Before moving to their shooting positions, all youth must participate in a Cowboy action shooting safety briefing as outlined in Appendix 4. The course of fire—option 1 or 2 below—should be determined before the briefing by the person in charge of shooting sports for the camp or activity. The course of fire must be clearly explained during the briefing so that participants understand what they are to do at each station, and when and where they are to move.

- After the briefing, each shooter will choose their own Cowboy action name so the NRA instructors, dressed in cowboy attire, may call them by these names.
- Cowboy scenery for four different shooting positions will be located on the walkway of the western-style structure.

### **COURSE OF FIRE OPTION 1**

- The shooter starts at the left shooting station (shooting position 1), placing their hands on the shelf until commanded by the RSO to commence firing.
- Once the RSO has given the firing command, the shooter picks up the lever-action rifle, fires six rounds at spinning rifle targets, opens the action, and then sets down the rifle.
- The shooter then moves to the first window (shooting position 2), picks up the first pistol, and fires six rounds at a flatiron pistol target. When finished, the shooter opens the cylinder loading gate and sets down the pistol.
- Then the shooter moves to the second window (shooting position 3), picks up the second pistol, fires six rounds at another flatiron target, and repeats the procedure of opening the cylinder loading gate and setting down the pistol.
- The shooter now moves to the right end of the structure (shooting position 4), picks up the shotgun, and fires two shots at a ground target. When finished, the shooter ejects the shells and sets down the shotgun.
- Finally, the shooter walks back to the ready line. When the RSO has given the “all clear” command, the next shooter can move to the ready position.

### **COURSE OF FIRE OPTION 2**

- The shooter starts at the left shooting station (shooting position 1), placing their hands on the shelf until commanded by the RSO to commence firing.
- Once the RSO has given the firing command, the shooter picks up the lever-action rifle, fires six rounds at spinning rifle targets, opens the action, and then sets down the rifle.
- Then the shooter, remaining at the left end of the structure, picks up the pistol and fires six rounds at a pistol target. When finished, the shooter opens the cylinder loading gate and sets down the pistol.
- The shooter now moves to the right end of the structure (shooting position 4), picks up the shotgun, and fires two shots at a ground target. When finished, the shooter ejects the shells and sets down the shotgun.
- The shooter then walks back to the ready line. When the RSO has given the “all clear” command, the next shooter can move to the ready position.



## SAMPLE BUDGET

Below is a sample startup/one-year budget for the Cowboy action shooting program. (Costs may vary by council.)

DESCRIPTION	PRICE	QTY	TOTAL COST
<b>ONE-TIME STARTUP COSTS</b>			
NRA PISTOL, RIFLE, AND SHOTGUN CERTIFICATION	\$100	6 (2 PER DISCIPLINE)	\$600
.22-CALIBER REVOLVERS	\$450	2	\$900
.22-CALIBER LEVER-ACTION RIFLES	\$500	2	\$1000
12-GAUGE OR 20-GAUGE PUMP- OR BREAK-ACTION SHOTGUNS	\$400	2	\$800
METAL TARGETS (IF USED)	\$150	4	\$600
EYE PROTECTION	\$6	12	\$72
STAGE CONSTRUCTION			\$1500
<b>TOTAL ONE-TIME COSTS</b>			<b>\$5,472</b>
<b>ONGOING YEARLY ESTIMATED COSTS (PER 100 SHOOTERS)</b>			
AMMUNITION			\$150
GUN CLEANING CONSUMABLES			\$150
EAR PROTECTION			\$100
<b>TOTAL ESTIMATED YEARLY COSTS</b>			<b>\$400</b>

If you have questions or would like additional information about this program, contact [shooting.sports@scouting.org](mailto:shooting.sports@scouting.org)

# APPENDIX 14.A

## SAMPLE PERMISSION FORM

Camp \_\_\_\_\_

*Scout Cowboy Action Shooting Program Participation And Hold Harmless Agreement*

Camp \_\_\_\_\_ (\_\_\_\_\_ Council) will be conducting a Scout Cowboy action shooting program. In this program, Scouts will shoot a rifle, pistol, and shotgun under the supervision of an NRA Range Safety Officer and NRA certified instructors. Scouts will be required to wear eye protection and hearing protection at all times while on the range. Scouts are expected to abide by all safety rules and the instructions of the Range Safety Officer(s) and rifle, pistol, and shotgun instructor(s).

I, the undersigned, give my child, \_\_\_\_\_, permission to participate in this program. I understand that participation in the activity involves a certain degree of risk. I have carefully considered the risk involved and have given consent for my child to participate in the activity. I understand that participation in the activity is entirely voluntary and requires participants to abide by the rules and standards of conduct. I release the Boy Scouts of America, the local council, the activity coordinators, and all employees, volunteers, related parties, or other organizations associated with the activity from any and all claims or liability arising out of this participation.

**For safety, my child and I agree that they will do the following or they will be removed from the program.** I understand that any additional cost associated with participation in this program will not be refunded if my child is removed for not following the rules below.

1. Complete a range safety briefing.
2. Wear all safety gear at all times while on the range.
3. Follow all the safety rules provided in the briefing.
4. Follow the instructions of the Range Safety Officer(s) and rifle, pistol, and shotgun instructor(s).
5. Do not handle the firearms until instructed to do so by the instructor(s).
6. Is 14 years of age, or 13 and has completed the eighth grade, as of the start of the class and will be in full compliance with all local, state, and federal guidelines, including age restrictions and original equipment manufacturer standards.

Participant signature \_\_\_\_\_ Date: \_\_\_\_\_

Parent/guardian signature \_\_\_\_\_ Date: \_\_\_\_\_

Parent/guardian printed name \_\_\_\_\_ Date: \_\_\_\_\_

Home phone \_\_\_\_\_ Cell \_\_\_\_\_ Date: \_\_\_\_\_

Email address: \_\_\_\_\_

# APPENDIX 14.B

## RANGE DESIGNS

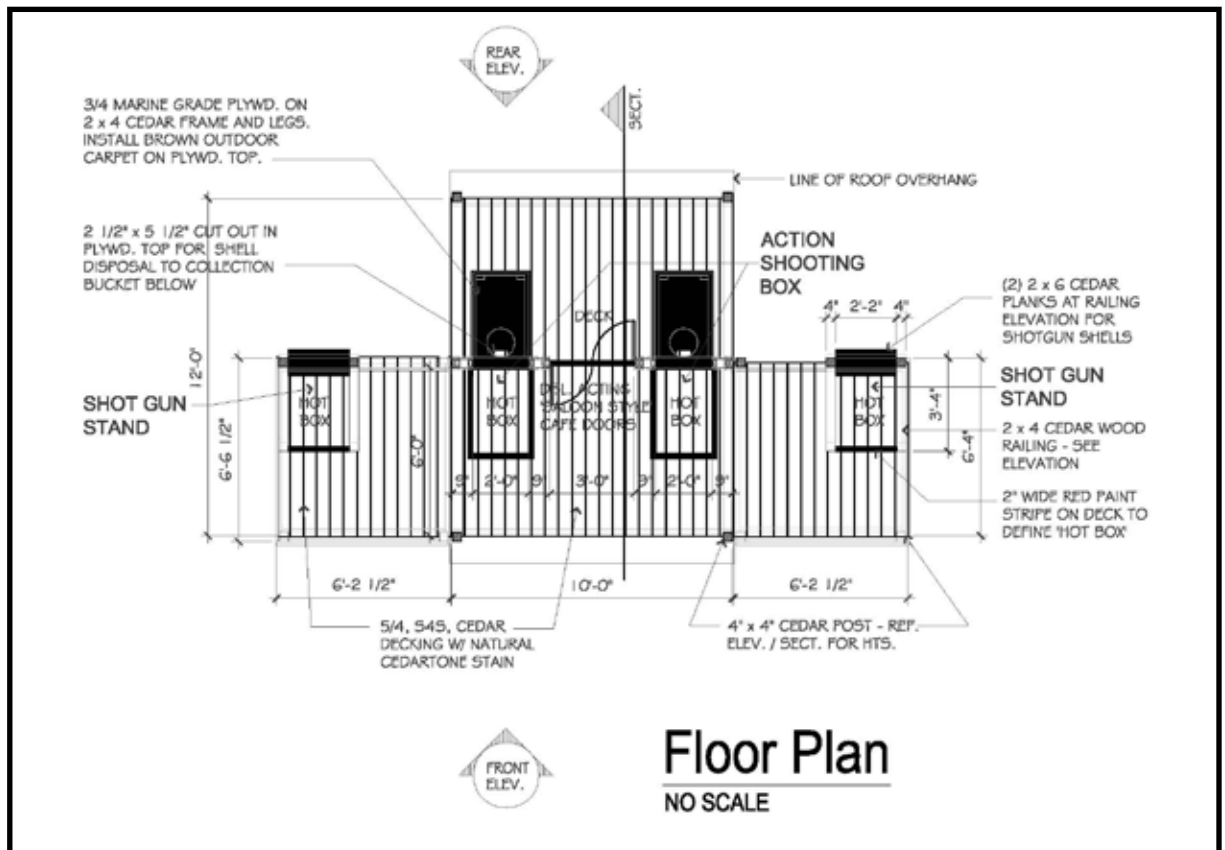
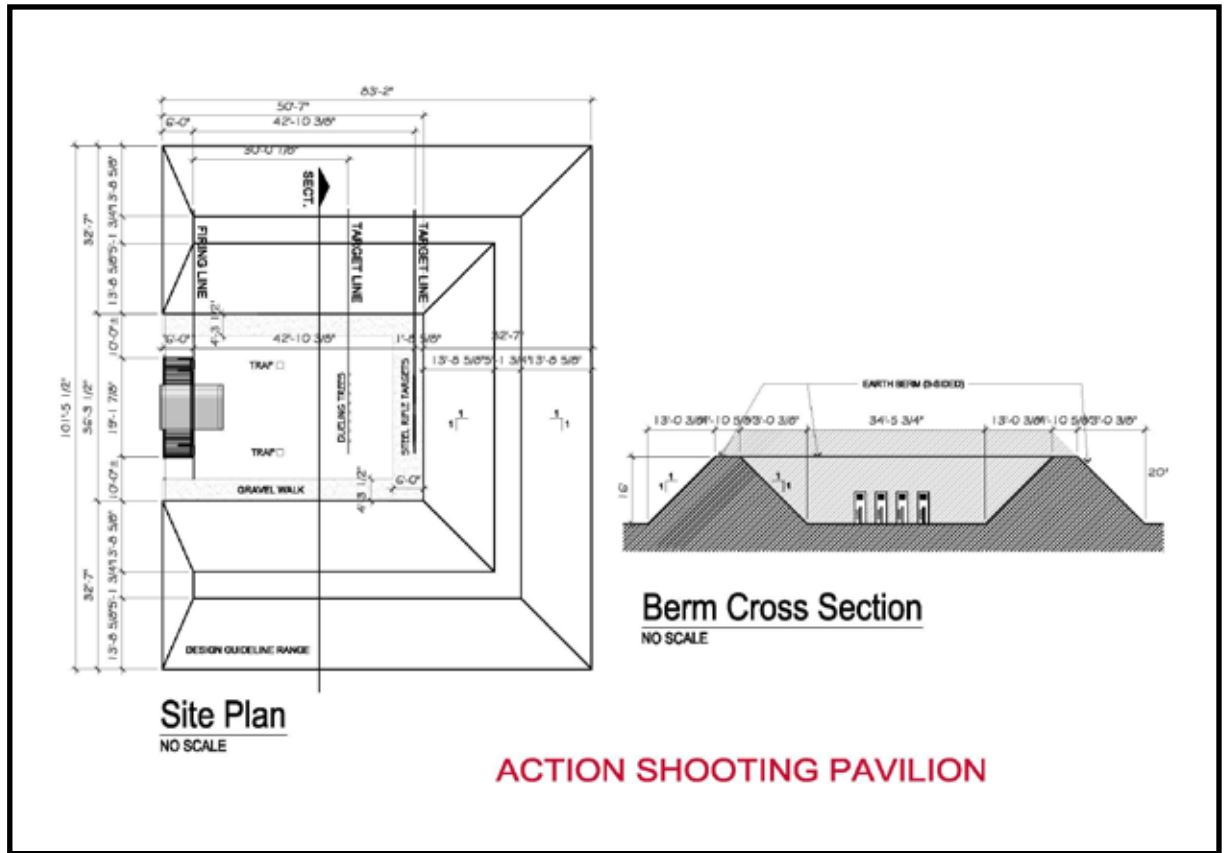

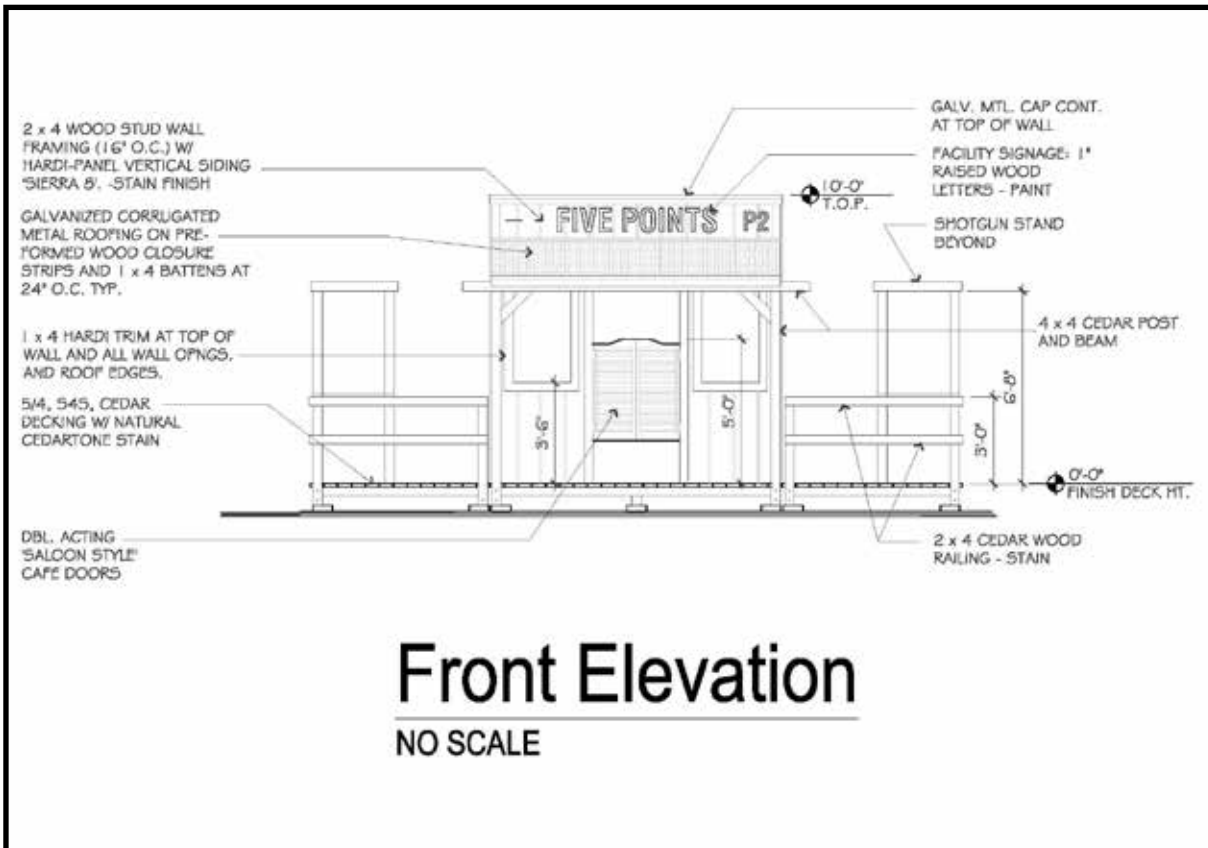
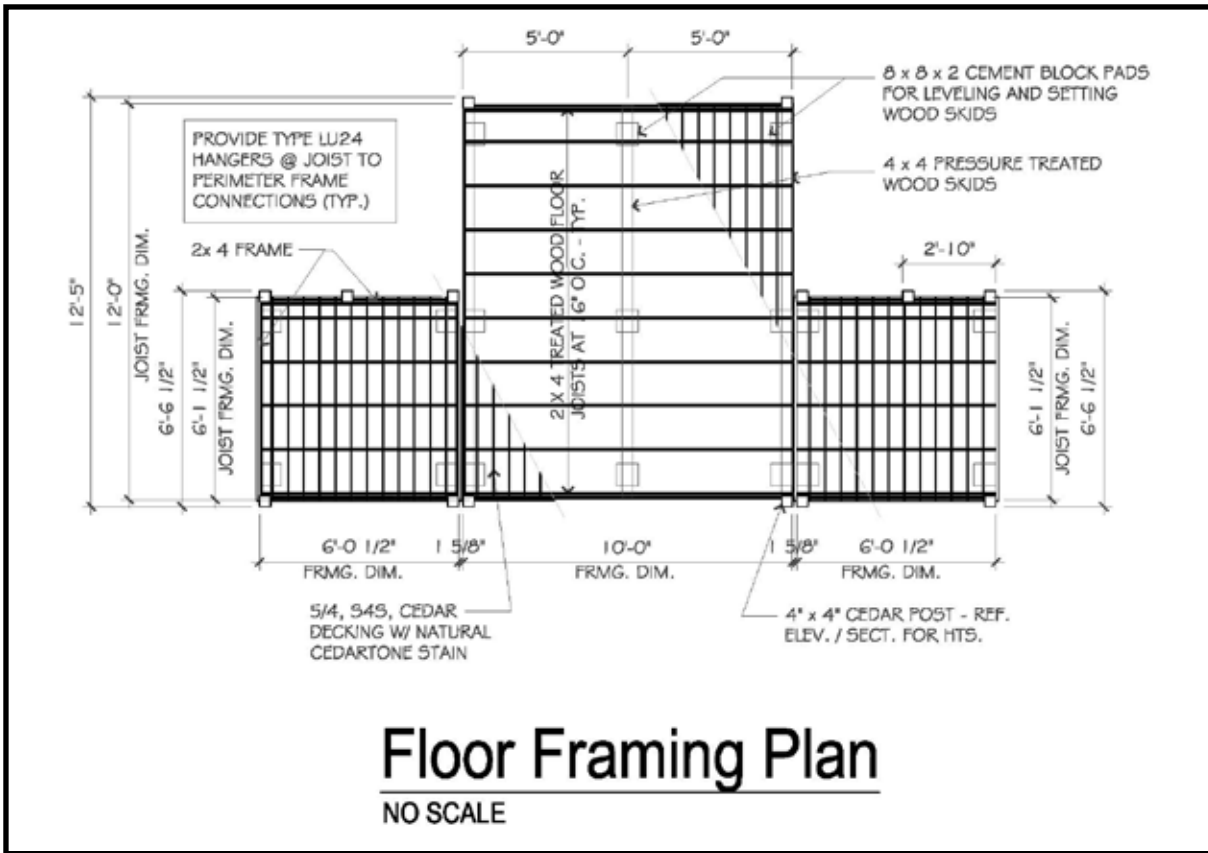

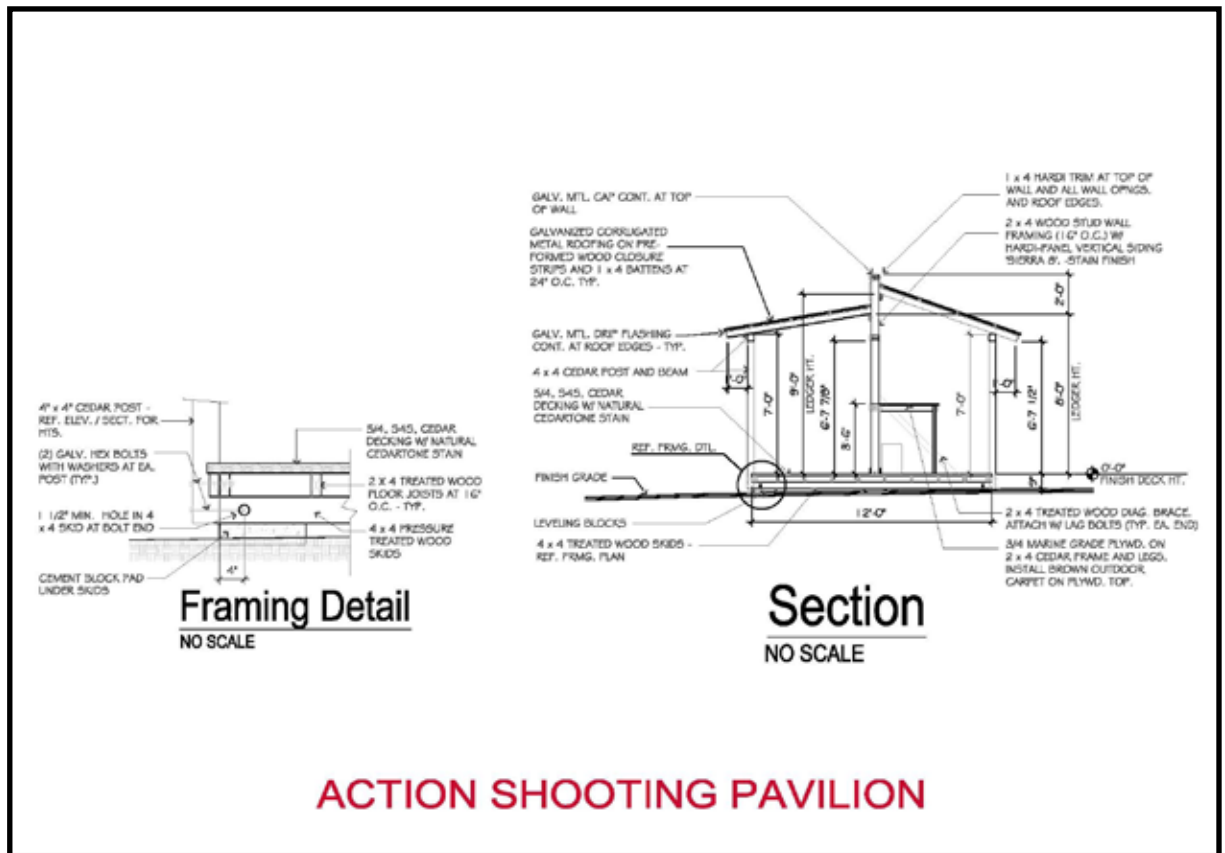
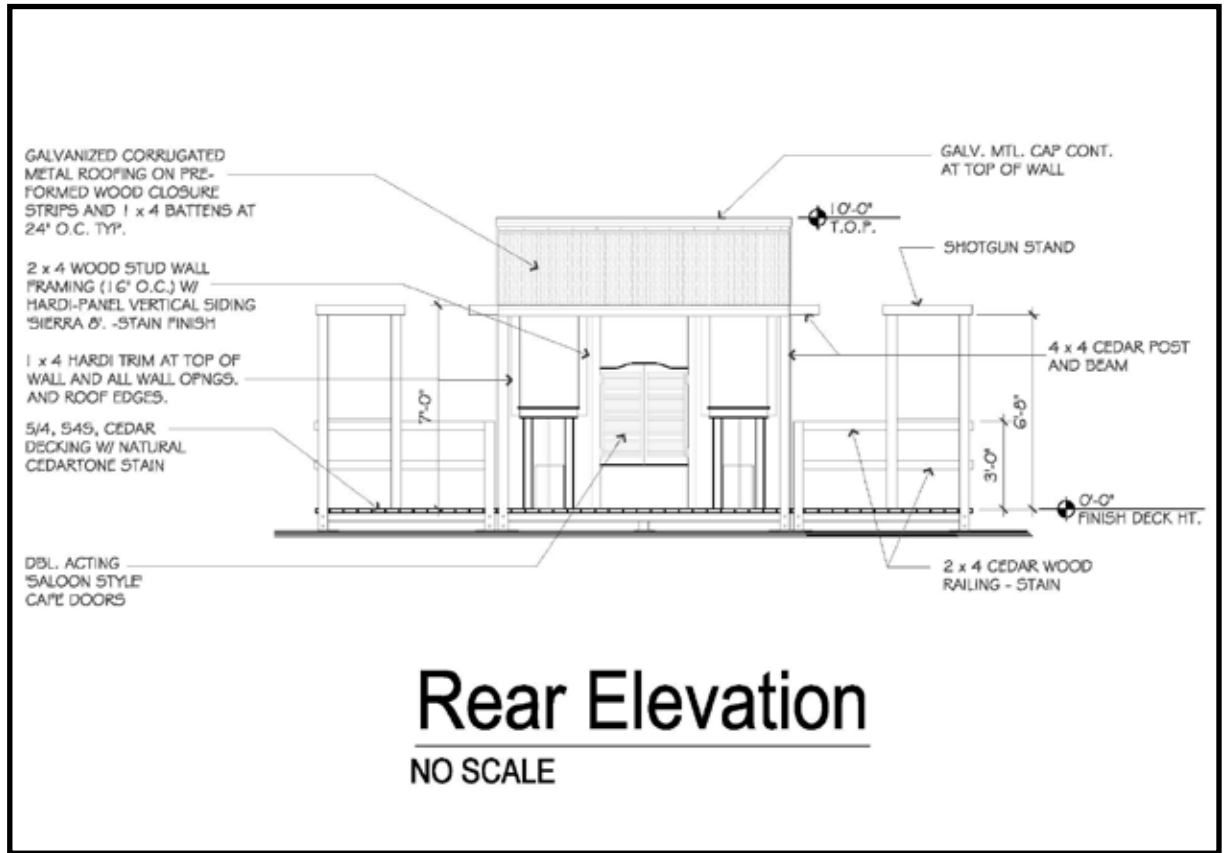

## APPENDIX 14.C

### SAMPLE COWBOY ACTION RANGE INSPECTION CHECKLIST

Inspected by \_\_\_\_\_ Date \_\_\_\_\_

√ = Yes

- Controlled access/fencing/gates closed
- Flags or signs displayed
- Left and right range limits displayed
- Backstop/impact area inspected
- Lumber boards painted and visible
- Target frames/mounts in good repair
- Firing line marked
- Firing points numbered/clean
- Shooting benches/tables inspected
- Sandbags/gun rests on hand
- Ready line/area marked
- Spectator area designated
- Scoring area established
- Supplies available
- NRA RSO control area centralized
- Emergency communications working
- First-aid kit filled/accessible
- Range rules posted
- Bulletin board hung
- Gun racks available
- Empty trash receptacles available
- Brass/dud buckets labeled
- Trash area identified
- Lockable storage

## APPENDIX 14.D

### SAMPLE COWBOY ACTION SHOOTING SCENARIOS

These scenarios are provided as suggestions. You should change the names and places to fit your camp or make up your own scenario to fit the history of your area.

#### SCENARIO 1

Mayor V. Augustine has seen Bad Bob Gibbens and his Baldnobbers Gang crossing Bow Creek! The mayor ordered Marshal Larry Maly to get a posse and stop Bad Bob's band from holding up Uncle Kev Rittel's Trading Post. (Bad Bob has a terrible hankerin' for them slushies that Kev serves up there.) Marshal Maly has deputized you to keep the Baldnobbers out of the trading post.

#### SCENARIO 2

Ranger Rex and Popcorn Patty were crossing the plains of Kirwin when they stopped their wagon outside of Greg's Trading Post. They were stocking up on fixin's for those famous covered-wagon turkey sandwiches. Next thing they knew, the Tom W. Turkey Gang had surrounded the store. These gobblers were tired of being hunted and were out to take prisoners. They started to tie up and gag Ranger Rex so he couldn't make turkey sandwiches for the Scouts. But Popcorn Patty grabbed her Dutch oven to clobber those thieving gobblers, and screamed for help. Sheriff Slim Maly and Deputy Greenback Greg came a'running, rallying a posse to fend off the Tom W. Turkey Gang.



## APPENDIX 14.E

### COWBOY ACTION SHOOTING SAFETY BRIEFING

**Note: This briefing is best done within viewing range of the Cowboy action shooting range. When firearms are used during the briefing, the NRA RSO must follow the NRA gun safety rules.**

Cowboy action shooting consists of shooting multiple shots from a loaded .22-caliber lever-action rifle, a .22-caliber single-action pistol, and a 12- or 20-gauge shotgun at non-human form action targets in an Old West setting.

Have participants read the NRA "Range Safety Rules" poster.

Review the NRA's three "Fundamental Rules for Safe Gun Handling" (verbatim), and discuss general range rules (see below). Ask questions for reinforced learning.

#### PURPOSE OF THE SHOOTING EVENT

- Tell participants that they will engage in Cowboy action recreational shooting on the range.
- Explain that they will shoot a total of 14 rounds—six from the pistol, six from the rifle, and two from the shotgun. (Note: Those totals are for option 2; revise the numbers if using option 1.)
- A trained instructor will be at each shooting station to provide guidance and instruction. The role of each instructor and the NRA RSO is to provide a safe environment for the shoot.

#### RANGE LAYOUT AND LIMITS

- Point out and describe the range layout, and explain what stations will be used and which guns will be shot at each station.
- Describe the ready line and firing line. Explain the purpose of the lines and when shooters are expected to be at each line.
- Inform everyone that the spectator line is located behind the ready line. This is where all non-shooters will remain until authorized to enter the range.

#### HOW THE SHOOTING EVENT WORKS

Have one instructor demonstrate the course of fire option that has been selected, without using a loaded gun or live fire. Be sure to cover how shooters will move through the course and handle shooting at each station. (See course of fire descriptions on pages 6 and 7 of this guide.)



## SAFETY RULES

### Three fundamental NRA rules for safe gun handling:

Ask: What is the first rule of safe gun handling?  
— Always keep the gun pointed in a safe direction.

Ask: What does a “safe direction” mean?  
— The gun is pointed so that even if it were to go off, it would not cause injury.

Ask: What is the second rule of safe gun handling?  
— Always keep your finger off the trigger until ready to shoot.

Ask: Unless shooting, where should the shooter’s finger(s) rest?  
— The finger(s) should rest alongside the gun, i.e., on the frame, receiver, or trigger guard.

Ask: What is the third rule of safe gun handling?  
— Always keep the gun unloaded until ready to use.

Emphasize that safeties can fail. Safe gun-handling rules should be followed all the time!

### Rules for safe use

*Know your target and what is beyond.*

Ask: What is meant by “know your target and what is beyond”?  
— The shooter must be sure that projectiles will safely hit the backstop.

*Be sure the gun is safe to operate.*

*Know how to use the gun safely.*

Ask: What is meant by “know how to use the gun safely”?  
— Shooters need to know how the firearm operates, its basic parts, how to safely open and close the action, and how to remove ammunition.

*Use only the correct ammunition for your gun.*

Ask: What is meant by “use only the correct ammunition”?  
— Only ammunition designed for a particular gun can be safely fired in that gun.  
— Shooters should ensure that the caliber marked on the barrel, ammo box, and cartridge case match. This is especially true for antique firearms.

*Wear eye and ear protection as appropriate.*

Ask: Why should course users wear eye and ear protection?  
— Guns are loud and the noise can cause hearing damage. Guns can also emit debris, hot gas, and cartridge cases that could cause eye injuries.

*Never use alcohol or drugs before or while shooting.*

Ask: What type of substance is implied by “never use alcohol or drugs”?  
— It refers to any substance that may impair normal mental or physical bodily functions.

## GENERAL RANGE SAFETY RULES

Have all range users read the rules as the NRA RSO points to range posters or refers to handouts.

- Know and obey all range commands.
- Know where others are at all times.
- Shoot only at authorized targets. Also, note that shooting at different targets at different distances or angles can result in hazardous conditions.
- Do not handle a firearm or stand at the firing line where firearms are present while others are down-range.
- Stop shooting immediately upon the command to “cease fire,” and await further instructions from the NRA RSO.

## NRA HYGIENE GUIDELINES

Explain that the following NRA hygiene guidelines can minimize one’s exposure to airborne lead particles and cleaning product residues. Emphasize that these guidelines apply even to non-shooters exposed at the range or cleaning area because they, too, can be affected.

- Wash your hands and face with cold water after leaving the range or cleaning area, and before eating or drinking.
- Change and wash clothing after shooting or cleaning a gun to minimize exposure to airborne lead particles, cleaning product residues, or solvent.
- Leave dropped ammunition on the floor until the course of fire is completed and firearms are benched or grounded. This policy prevents shooters from unintentionally pointing the firearm at other users while picking up the ammunition, or moving in front of the firing line.
- Notify the NRA RSO when there is a firearm stop-page malfunction.
- Dry firing is permitted only at the firing line and only when authorized.
- All firearms must remain unloaded with actions open except when the guns are on the firing line and authorized to be loaded.
- When firearms are benched or grounded, keep the actions open and the ejection ports facing upward so the chambers are visible.
- Ammunition is not permitted in the cleaning area.

## **FIRING LINE COMMANDS**

Explain the standard range commands for Cowboy action shooting:

“Is the line ready?” allows any shooter who is having problems to raise an arm and call, “Not ready on target (number)!”

“Commence firing!” signals shooters to begin shooting.

“Cease firing!” tells shooters to immediately stop firing and await further instructions. This command can also be given by shooters if they observe an unsafe condition.

“Range is clear” means all guns are benched.

“Police your firing point” means to pick up empty cartridges.

## **EMERGENCY PROCEDURES**

- Take charge of the situation. (Determine the seriousness of any injuries and assign duties.)
- Render aid. The first-aid kit should be centrally located.
- Call for help via radio.
- Direct help to wherever it is needed.

# APPENDIX 15 - INSTRUCTIONAL RIFLE SHOOTING EXPERIENCE

For Scouts BSA, Venturers And Sea Scouts

## INTRODUCTION

This guide is intended to provide units, districts and councils with an overview of the requirements for running the shooting program ensuring all BSA Policies are followed under NRA Certified Rifle Instructor and NRA Range Safety Officer (RSO). In this publication, you will find youth requirements, training requirements for adults who are facilitating a safe handling Rifle instruction program for youth.

## PROGRAM GUIDELINES

### Youth Requirements

Registered Scouts BSA members, Venturers or Sea Scouts and youth who are age appropriate participating in a Rifle instructional curriculum designed to develop and improve shooting skills. All youth participants are required to have written permission from their parent or guardian before they can take part in the program. A sample permission form is included in the back of this guide. The council may also include this as part of the overall permissions for the camp or activity; however, it must clearly state that a youth has the parent or guardian's permission to handle and fire a firearm.



## STANDARD OPERATING PROCEDURES

The standard operating procedures (SOPs) of the range should also be reviewed by NRA Range Safety Officer before delivering this program. All firearms must be approved for use by the NRA Range Safety Officer.

## THE RANGE

An approved range can include:

- BSA Range
- Public Range
- Private Range
- Commercial range
- Private Property Range.

Public, private property or commercial ranges must be certified using the application found here:

[Click here](#) or type this address in browser

<https://www.scouting.org/outdoor-programs/shooting-sports/permission/>

## ADULT SUPERVISION AND TRAINING REQUIREMENTS

1. BSA Youth Protection policies for two deep leadership must be maintained at all times.
2. Instructors must have current certification as an NRA Instructor
3. RSO must have current certification as an NRA Range Safety Officer (RSO).

## APPLICABLE LAWS

BSA safety policies generally run parallel to or go beyond legal mandates. However, it is the camp or activity supervisor's responsibility to confirm and ensure compliance with all applicable federal, state, and local regulations or statutes related to youth handling and using a firearm.

## INSTRUCTIONAL SHOOTING SPORTS PROGRAM

**Purpose:** Teach youth the Knowledge, Skill and Attitude (KSA) of safe handling of a Rifle by participation in a formal Rifle shooting curriculum.

**Examples:** Examples of instructional programs are the Scouts BSA Rifle Shooting Merit Badge, Venturing Ranger Award and Sea Scout Shooting Sports Medal. Shooting programs could be held at a BSA facility, public, private, commercial or club range.

**Youth:** Scouts BSA, Venturers, Sea Scouts

- **Scouts BSA.** .22 caliber rimfire, bolt-action rifle. Either a breech-loading, single-shot, bolt-action or a repeater bolt action with a box magazine can be used. Tubular or high-capacity magazines are not allowed. If magazines are used, the range commands must include “magazines out after firing all rounds” to ensure the firing line is safe after all shots are fired. This now means a Scout can load more than one round directly into the box magazine to shoot. The trigger pull will be 3 pounds or greater.

Lever action and tubular magazine rifles are approved for use in the Cowboy Action Program ONLY.

- **Venturers and Sea Scouts.** Any cartridge-firing rifle with open, scope, or dot sights

**Ammunition:** Correct ammunition for the rifle being fired. Tracer, armor-piercing, and explosive ammunition are not allowed.

**Reloaded ammunition is not approved for BSA programs.**

**Range:** A BSA-approved facility, public, private, commercial or club range. Note that if using private property for the range location, you must follow the BSA private property range approval process, which can be found in the appendix. This information can also be found at [Download Private Property Approval Form](#).

**Instruction for Scouts BSA members:** NRA Basics of Rifle Shooting Course (eight hours), Rifle Merit Badge. Taught only by an NRA Rifle Instructor.

**Instruction for Sea Scouts and Venturers:** Sea Scout Shooting Sports, Venturing Ranger Award or NRA Basics of Rifle Shooting Course (eight hours). Taught only by an NRA Rifle Instructor.

**Required for Scouts BSA members:** BSA Rifle Safety Briefing in this document.

**Required for Sea Scouts and Venturers:** BSA Rifle Safety Briefing in this document.

**Instruction References:** Scouts BSA Rifle Merit Badge Pamphlet; [Download Sea Scout Shooting Sports Requirements](#); [Download Ranger Award Requirements](#)

**Safety:** ANSI Z87.1-2010 certified eye protection and appropriate hearing protection is required.

**Range supervision:** A certified NRA Range Safety Officer is to directly supervise all live fire on the range. Additionally a currently certified NRA Rifle Instructor must provide support to the shooters during live fire. These must be two separate individuals.

**Ratio:** One NRA Range Safety Officer (1:8) must be present for each group consisting of a maximum of

eight shooters. One NRA certified Rifle Instructor per eight active (1:8) shooters is required when loading and firing a Rifle.

**Course:** Scouts BSA Merit Badge: Using a .22 caliber rimfire rifle and shooting from a bench rest or supported prone position at 50 feet, fire five groups (three shots per group) that can be covered by a quarter.

**Course for Sea Scouts and Venturing:** [Download Sea Scout Shooting Sports Requirements](#); [Download Ranger Award Requirements](#)

**NRA Basic Rifle Shooting Course:** Shooting activities are described in the course lesson plans. NRA Winchester Qualification Program: Use this program to recognize success as shooters progress.

#### **Sample Range commands**

- “Eye and ear protection on”
- “Shooters to the ready line.”
- “Shooters to the firing line”
- “Is the line ready?”
- “Load.”
- “Ready on the firing line.”
- “Commence firing.”
- “Cease fire.”
- “Remove magazines”

#### **BEFORE YOUTH ARRIVE AT THE PROGRAM AREA**

All Rifles, ammunition, and targets are provisioned in sufficient quantity to run the program for all shooters without interruption during non-program times by maintenance and support personnel.

#### **ON THE RANGE**

- Eye and ear protection should be cleaned between each shooter.
- Range staff will assist the NRA RSO and Instructor by preparing rifles, ammunition to the preparation table, and setting up shooting positions on range.
- General staging areas for shooters and those waiting their turn are clearly marked and safe gun handling rules posted.

**People in program areas adjacent to the firing line must wear ear protection if measured sound levels are 85 dB (decibel) or above.**

#### **WHEN YOUTH ARE PRESENT IN THE PROGRAM AREA**

Welcome youth to the area and begin the gun handling safety briefing. NRA Range Safety Officer(RSO) is responsible for all activities on the range.

## RANGE INSPECTION CHECKLIST

Inspected by \_\_\_\_\_ Date \_\_\_\_\_

√ = Yes

- Controlled access/fencing/gates closed
- Flags or signs displayed
- Range limits identified
- Backstop/impact area inspected
- Ready line/area marked
- Spectator area designated
- Supplies available
- First-aid kit filled/accessible
- Range rules posted
- Bulletin board available
- Rifle racks available
- Empty trash receptacles available
- Lockable storage
- Throwers available and loaded
- Eye and ear protection available
- Hand washing Station Available

## Range Safety Briefing – Rifle

- No LIVE Ammunition in the classroom!
- To provide beginning shooters with Knowledge, Skill and Attitude (KSA) necessary to shoot a Rifle safely under supervision of a certified instructor.
- 3 Rules of Gun Safety
  - Always keep your gun pointed in a safe direction
  - Always keep your finger off the trigger until ready to shoot
  - Always keep your gun unloaded until ready to use.
- Parts of a Rifle
- Demonstrate Rifle operation
  - Loading dummy rounds
  - Cocking
  - Dry Fire
  - Unloading
- Shooting Fundamentals
  - Dominant Eye
  - Position
  - Shooting Fundamentals
    1. Aiming
    2. Hold Control
    3. Breath Control
    4. Trigger Control
    5. Follow-through
- Range Layout
  - Ready Area
  - Firing Line
  - Target Area
  - Back Stop
- Other Safety Rules
  - Know your target and what is beyond
  - Eye and Ear Protection
  - No alcohol or drugs
  - Proper hygiene
  - Clean up after shooting
- Range Commands
  - “Eye and ear protection on”
  - “Shooters to the ready line.”
  - “Shooters to the firing line”
  - “Is the line ready?”
  - “Load.”
  - ”Ready on the firing line.”
  - “Commence firing.”
  - “Cease fire.”
  - “Remove magazines”

Before running a program check out the Shooting Sports Webpage for updates to this program guide and find other resources.

For questions or additional information, contact the National Service Center at [shootingsports@scouting.org](mailto:shootingsports@scouting.org)

## SAMPLE PERMISSION FORM

### Scouting Participation and Hold-Harmless Agreement

\_\_\_\_\_ (Unit, District or Council) is conducting a shooting sports program. Scouts will be instructed how to handle, maintain, and shoot a Rifle safely and be provided instruction to increase their shooting skills. Scouts will have classroom instruction and range instruction in which they will fire a rifle under the supervision of a trained NRA Range Safety Officer and NRA certified Rifle Instructor.

Scouts will be required to wear eye protection and hearing protection always while on the range. Scouts are expected to abide by all safety rules and the instructions of the Range Safety Officer(s) and Rifle Instructor(s).

I, the undersigned, give my child, \_\_\_\_\_, permission to participate in this program. I understand that participation in the activity involves a certain degree of risk.

I have carefully considered the risk involved and have given consent for my child to participate in the activity. I understand that participation in the activity is entirely voluntary and requires participants to abide by the rules and standards of conduct. I release the Boy Scouts of America, the local council, the activity coordinators, and all employees, volunteers, related parties, or other organizations associated with the activity from all claims or liability arising out of this participation.

For safety, my child and I agree that they will do the following or they will be removed from the program. I understand that any additional cost associated with participation in this program will not be refunded if my child is removed due to behavioral problems.

1. Complete the training offered as part of the program.
2. Wear all safety gear always while on the range.
3. Follow all safety rules provided in the training class.
4. Follow the instructions of the NRA Range Safety Officer(s) and Rifle Instructor(s).
5. Do not handle any Rifles until instructed to do so by the NRA Rifle Instructor(s).
6. Follow the instructions of the NRA Range Safety Officer(s) always.
7. Is a registered Scouts BSA member, Venturer, or Sea Scout

Participant signature \_\_\_\_\_ Date: \_\_\_\_\_

Parent/guardian signature \_\_\_\_\_ Date: \_\_\_\_\_

Parent/guardian printed name \_\_\_\_\_ Date: \_\_\_\_\_

Home phone \_\_\_\_\_ Cell phone \_\_\_\_\_





# APPENDIX 16 - OPEN RIFLE SHOOTING EXPERIENCE

## For Scouts BSA Members, Venturers And Sea Scouts

### INTRODUCTION

This guide is intended to provide units, districts and councils with an overview of the requirements for running the shooting program ensuring all BSA Policies are followed under NRA Certified Rifle Instructor and Range Safety Officer (RSO). In this publication, you will find youth requirements, training requirements for adults who are providing the program for camp and weekend program venues. The program offers a fun and safe introduction to safe handling of a rifle.

### PROGRAM GUIDELINES

#### Youth Requirements

Registered Scouts BSA members, Venturers or Sea Scouts, and youth who are age-appropriate participating in a Council, District or Unit organized Rifle Shooting activity conducted as part of a weekend campout, camporee or similar event. All youth participants are required to have written permission from their parent or guardian before they can take part in the program. A sample permission form is included in the back of this guide. The council may also include this as part of the overall permissions for the camp or activity; however, it must clearly state that a youth has the parent or guardian's permission to handle and fire a firearm.



### STANDARD OPERATING PROCEDURES

The standard operating procedures (SOPs) of the range should also be reviewed by NRA Range Safety Officer before delivering this program. All firearms must be approved for use by the NRA Range Safety Officer.

### THE RANGE

An approved range can include:

- BSA Range
- Public Range
- Private Range
- Commercial range
- Private Property Range.

Public, private property or commercial ranges must be certified using the application found here:

[Click here](#) or type this address in browser

<https://www.scouting.org/outdoor-programs/shooting-sports/permission/>

### ADULT SUPERVISION AND TRAINING REQUIREMENTS

1. BSA Youth Protection policies for two deep leadership must be maintained at all times.
2. Instructors must have current certification as an NRA Instructor
3. RSO must have current certification as an NRA Range Safety Officer (RSO).

### APPLICABLE LAWS

BSA safety policies generally run parallel to or go beyond legal mandates. However, it is the camp or activity supervisor's responsibility to confirm and ensure compliance with all applicable federal, state, and local regulations or statutes related to youth handling and using a firearm.

## OPEN RIFLE SHOOTING SPORTS EXPERIENCE

**Purpose:** Teach youth the Knowledge, Skill and Attitude (KSA) of safe handling of firearm in a shooting sports program.

**Examples:** A day-at-the-range event (fun shoot), Venturing or Sea Scout event, NRA Day event (contact the National Association for information on NRA Day), Winchester/NRA Marksmanship Qualification Program, camporee, camp weekend shoot, or Order of the Arrow event are examples. An open shooting experience could be held at a BSA facility, public or private commercial range or private property.

**Youth:** Scouts BSA members, Venturers, Sea Scouts

- **Scouts BSA members.** .22 caliber rimfire, bolt-action rifle. Either a breech-loading, single-shot, bolt-action or a repeater bolt action with a box magazine can be used. Tubular or high-capacity magazines are not allowed. If magazines are used, the range commands must include “magazines out after firing all rounds” to ensure the firing line is safe after all shots are fired. This now means a Scout can load more than one round directly into the box magazine to shoot. The trigger pull will be 3 pounds or greater.

Lever action and tubular magazine rifles are approved for use in the Cowboy Action Program ONLY.

- **Venturers and Sea Scouts.** Any cartridge-firing rifle with open, scope, or dot sights

**Ammunition:** Correct ammunition for the rifle being fired. Tracer, armor-piercing, and explosive ammunition are not allowed.

### **Reloaded ammunition is not approved for BSA programs.**

**Range:** A BSA-approved facility, public, private, commercial or club range. Note that if using private property for the range location, you must follow the BSA private property range approval process, which can be found in the appendix. This information can also be found at [Download Private Property Approval Form](#).

**Required for Scouts BSA members:** BSA Rifle Safety Briefing in this document.

**Required for Sea Scouts and Venturers:** BSA Rifle Safety Briefing in this document. Safety. ANSI Z87.1-2010 certified eye protection and appropriate hearing protection is required.

**Range supervision:** A certified NRA Range Safety Officer is to directly supervise all live fire on the range. Additionally, the instruction offered must be done by a currently certified NRA certified Rifle Instructor. These must be two separate individuals.

**Ratio:** One NRA Range Safety Officer must be present for each group consisting of a maximum of eight shooters. And one NRA certified Rifle Instructor per 8 shooters during live fire.

**Course:** Shoot one or two 5-shot targets per relay, from a position appropriate to the skill level of the participants.

### **Sample Range commands**

- “Eye and ear protection on”
- “Shooters to the ready line.”
- “Shooters to the firing line”
- “Is the line ready?”
- “Load.”
- “Ready on the firing line.”
- “Commence firing.”
- “Cease fire.”
- “Remove magazines”

## BEFORE YOUTH ARRIVE AT THE PROGRAM AREA

All Rifles, ammunition, and targets are provisioned in sufficient quantity to run the program for all shooters without interruption during non-program times by maintenance and support personnel.

### ON THE RANGE

- Eye and ear protection should be cleaned between each shooter.
- Range staff will assist the RSO and Instructor by preparing rifles, ammunition to the preparation table, and setting up shooting positions on range.
- General staging areas for shooters and those waiting their turn are clearly marked and safe gun handling rules posted.

**People in program areas adjacent to the firing line must wear ear protection if measured sound levels are 85 dB (decibel) or above.**

## WHEN YOUTH ARE PRESENT IN THE PROGRAM AREA

Welcome youth to the area and begin the gun handling safety briefing. Range Safety Officer(RSO) is responsible for all activities on the range.

## RANGE INSPECTION CHECKLIST

Inspected by \_\_\_\_\_ Date \_\_\_\_\_

√ = Yes

- Controlled access/fencing/gates closed
- Flags or signs displayed
- Range limits identified
- Backstop/impact area inspected
- Ready line/area marked
- Spectator area designated
- Supplies available
- First-aid kit filled/accessible
- Range rules posted
- Bulletin board available
- Rifle racks available
- Empty trash receptacles available
- Lockable storage
- Throwers available and loaded
- Eye and ear protection available
- Hand washing Station Available

## Range Safety Briefing – Rifle

- No LIVE Ammunition in the classroom!
- To provide beginning shooters with Knowledge, Skill and Attitude (KSA) necessary to shoot a Rifle safely under supervision of a certified instructor.
- 3 Rules of Gun Safety
  - Always keep your gun pointed in a safe direction
  - Always keep your finger off the trigger until ready to shoot
  - Always keep your gun unloaded until ready to us.
- Parts of a Rifle
- Demonstrate Rifle operation
  - Loading dummy rounds
  - Cocking
  - Dry Fire
  - Unloading
- Shooting Fundamentals
  - Dominant Eye
  - Position
  - Shooting Fundamentals
    1. Aiming
    2. Hold Control
    3. Breath Control
    4. Trigger Control
    5. Follow-through
- Range Layout
  - Ready Area
  - Firing Line
  - Target Area
  - Back Stop
- Other Safety Rules
  - Know your target and what is beyond
  - Eye and Ear Protection
  - No alcohol or drugs
  - Proper hygiene
  - Clean up after shooting
- Range Commands
  - “Eye and ear protection on”
  - “Shooters to the ready line.”
  - “Shooters to the firing line”
  - “Is the line ready?”
  - “Load.”
  - ”Ready on the firing line.”
  - “Commence firing.”
  - “Cease fire.”
  - “Remove magazines”

Before running a program check out the Shooting Sports Webpage for updates to this program guide and find other resources.

For questions or additional information, contact the National Service Center at [shootingsports@scouting.org](mailto:shootingsports@scouting.org)

## SAMPLE PERMISSION FORM

### Scouting Participation and Hold-Harmless Agreement

\_\_\_\_\_ (Unit, District or Council) is conducting a shooting sports program. Scouts will be instructed how to handle, maintain, and shoot a Rifle safely and be provided instruction to increase their shooting skills. Scouts will have classroom instruction and range instruction in which they will fire a rifle under the supervision of a trained NRA Range Safety Officer and NRA certified Rifle Instructor.

Scouts will be required to wear eye protection and hearing protection always while on the range. Scouts are expected to abide by all safety rules and the instructions of the Range Safety Officer(s) and Rifle Instructor(s).

I, the undersigned, give my child, \_\_\_\_\_, permission to participate in this program. I understand that participation in the activity involves a certain degree of risk.

I have carefully considered the risk involved and have given consent for my child to participate in the activity. I understand that participation in the activity is entirely voluntary and requires participants to abide by the rules and standards of conduct. I release the Boy Scouts of America, the local council, the activity coordinators, and all employees, volunteers, related parties, or other organizations associated with the activity from all claims or liability arising out of this participation.

For safety, my child and I agree that they will do the following or they will be removed from the program. I understand that any additional cost associated with participation in this program will not be refunded if my child is removed due to behavioral problems.

1. Complete the training offered as part of the program.
2. Wear all safety gear always while on the range.
3. Follow all safety rules provided in the training class.
4. Follow the instructions of the NRA Range Safety Officer(s) and Rifle Instructor(s).
5. Do not handle any Rifles until instructed to do so by the NRA Rifle Instructor(s).
6. Follow the instructions of the NRA Range Safety Officer(s) always.
7. Is a registered Scouts BSA member, Venturer, or Sea Scout

Participant signature \_\_\_\_\_ Date: \_\_\_\_\_

Parent/guardian signature \_\_\_\_\_ Date: \_\_\_\_\_

Parent/guardian printed name \_\_\_\_\_ Date: \_\_\_\_\_

Home phone \_\_\_\_\_ Cell phone \_\_\_\_\_





# APPENDIX 17 - INSTRUCTIONAL SHOTGUN EXPERIENCE

## For Scouts BSA Members, Venturers And Sea Scouts

### INTRODUCTION

This guide is intended to provide units, districts and councils with an overview of the requirements for running the shooting program ensuring all BSA Policies are followed under NRA Certified Shotgun Instructor and Range Safety Officer (RSO). In this publication, you will find youth requirements, training requirements for adults who are facilitating a Shotgun instruction program for youth. The program offers a fun and safe introduction to safe handling of a shotgun.

### PROGRAM GUIDELINES

#### Youth Requirements

Registered Scouts BSA members, Venturers or Sea Scouts and youth who are age appropriate participating in a Shotgun instructional curriculum designed to develop and improve shooting skills. All youth participants are required to have written permission from their parent or guardian before they can take part in the program. A sample permission form is included in the back of this guide. The council may also include this as part of the overall permissions for the camp or activity; however, it must clearly state that a youth has the parent or guardian's permission to handle and fire a firearm.



### STANDARD OPERATING PROCEDURES

The standard operating procedures (SOPs) of the range should also be reviewed by NRA Range Safety Officer before delivering this program. All firearms must be approved for use by the NRA Range Safety Officer.

### THE RANGE

An approved range can include:

- BSA Range
- Public Range
- Private Range
- Commercial range
- Private Property Range.

Public, private property or commercial ranges must be certified using the application found here:

[Click here](#) or type this address in browser

<https://www.scouting.org/outdoor-programs/shooting-sports/permission/>

### ADULT SUPERVISION AND TRAINING REQUIREMENTS

1. BSA Youth Protection policies for two deep leadership must be maintained at all times.
2. Instructors must have current certification from the NRA as a Instructor
3. RSO must have current certification from the NRA as a Range Safety Officer (RSO).

### APPLICABLE LAWS

BSA safety policies generally run parallel to or go beyond legal mandates. However, it is the camp or activity supervisor's responsibility to confirm and ensure compliance with all applicable federal, state, and local regulations or statutes related to youth handling and using a firearm.



### INSTRUCTIONAL SHOOTING SPORTS PROGRAM

**Purpose:** To develop in youth the Knowledge, Skill and Attitude (KSA) of safe handling of a Shotgun by participation in a formal Shotgun shooting curriculum.

**Examples:** Examples of ongoing programs are the Scouts BSA Shotgun Shooting Merit Badge, Venturing Ranger Award and Sea Scout Shooting Sports Medal. Shooting programs could be held at a BSA facility or public or private commercial range or club.

**Youth:** Scouts BSA members, Venturers, Sea Scouts

**Shotgun:** Youth- and adult-size 12 or 20 gauge gas-operated semi-automatic shotguns are recommended.

**Ammunition:** Correct ammunition for the shotgun being fired. Light loads of shot size #7½ or smaller is recommended. **Reloaded ammunition is not approved for BSA programs.**

**Range:** A BSA-approved range or a public or private commercial range or club. Note that if using private property for the range location, you must follow the BSA private property range approval process, which can be found in the appendix. This information can also be found at <https://www.scouting.org/outdoor-programs/shooting-sports/permission/>.

**Training for Scouts BSA members:** NRA FIRST Steps Shotgun Orientation (3 hrs.) or NRA Basic Shotgun Shooting Course (8 hrs.), taught by a certified NRA Shotgun Instructor. The BSA Shotgun Shooting Merit Badge

**Training for Sea Scouts and Venturers:** BSA Shotgun Safety Briefing in this document.

**Training References:** Scouts BSA Shotgun Merit Badge Pamphlet; [Download Sea Scout Shooting Sports Requirements](#); [Download Ranger Award Requirements](#)

**Safety:** ANSI Z87.1-2010 certified eye protection and hearing protection is required.

**Range supervision:** A certified NRA Range Safety Officer is to directly supervise all live fire on the range. Additionally, the instruction offered must be done by a currently certified NRA certified Shotgun Instructor. These must be two separate individuals.

**Ratio:** One NRA Range Safety Officer must be present for each group consisting of a maximum of six shooters. One NRA certified Shotgun Instructor for each active shooter is required when loading and firing a shotgun.

**Course:** Begin with slow, single, straight away and incoming targets. An example would be a single trap with one shell loaded at a time. As skill and confidence improve, provide more challenging target .

- Command: “Eye and ear protection on.”
- Command: “Move forward to your shooting position.”
- Command: “Practice mounting and following a target with the gun.”
- Command: “Load and prepare to fire.”
- Command: “Is the trapper ready?”
- Command: “Call “Pull” when shooter is ready.”

Continue until shooter has completed the course of fire.

- Command: “Cease fire.”
- Command: “Range is clear.”
- Command: “You may exit the shooting area.”
- Command: “Remove eye and ear protection.”

## **BEFORE YOUTH ARRIVE AT THE PROGRAM AREA**

All shotguns, ammunition, and targets are provisioned during non-program times by maintenance and support personnel in sufficient quantity to run the program for all shooters without interruption.

## **ON THE RANGE**

- Eye and ear protection should be cleaned between each shooter.
- Range staff will assist the RSO and Instructor by loading the trap, preparing shotguns, ammunition to the preparation table, and setting up shooting positions on range.
- General staging areas for shooters and those waiting their turn are clearly marked and safe gun handling rules posted.

**People in program areas adjacent to the firing line must wear ear protection if measured sound levels are 85 dba or above.**

## **WHEN YOUTH ARE PRESENT IN THE PROGRAM AREA**

Welcome youth to the area and begin the gun handling safety briefing. Range Safety Officer(RSO) is responsible for all activities on the range.

## RANGE INSPECTION CHECKLIST

Inspected by \_\_\_\_\_ Date \_\_\_\_\_

√ = Yes

\_\_\_ Controlled access/fencing/gates closed

\_\_\_ Flags or signs displayed

\_\_\_ Range limits identified

\_\_\_ Backstop/impact area inspected

\_\_\_ Ready line/area marked

\_\_\_ Spectator area designated

\_\_\_ Supplies available

\_\_\_ First-aid kit filled/accessible

\_\_\_ Range rules posted

\_\_\_ Bulletin board available

\_\_\_ Shotgun racks available

\_\_\_ Empty trash receptacles available

\_\_\_ Lockable storage

\_\_\_ Throwers available and loaded

\_\_\_ Eye and ear protection available

\_\_\_ Hand washing Station Available

## Range Safety Briefing – Shotgun

- No Ammunition in the classroom!
- To provide shooters with Knowledge, Skill and Attitude (KSA) necessary to shoot a shotgun safely under supervision of a certified instructor.
- 3 Rules of Gun Safety
  - Always keep your gun pointed in a safe direction
  - Always keep your finger off the trigger until ready to shoot
  - Always keep your gun unloaded until ready to us.
- Parts of a shotgun
- Demonstrate shotgun operation
  - Loading dummy rounds
  - Cocking
  - Dry Fire
  - Unloading
- Shooting Fundamentals
  - Determine Eye Dominance
  - Stance
  - Hold Point
  - Mount
  - See the target
  - Swing
  - Pull the trigger
  - Follow through
  - The most important - Focus on the target
- Range Layout
  - Ready Area
  - Firing Line
  - Target Area
  - Back Stop
- Other Safety Rules
  - Know your target and what is beyond
  - Eye and Ear Protection
  - No alcohol or drugs
  - Proper hygiene
  - Clean up after shooting
- Range Commands
  - Command: “Eye and ear protection on.”
  - Command: “Move forward to your shooting position.”
  - Command: “Practice mounting and following a target with the gun.”
  - Command: “Load and prepare to fire when it is your turn. Begin shooting from the left.”
  - Command: “Is the trapper ready?”
  - Command: “Call “Pull” when shooter is ready.”

Continue until shooter has completed the course of fire.

- Command: “Cease fire.”
- Command: “Range is clear.”
- Command: “You may exit the shooting area.”
- Command: “Remove eye and ear protection.”

Before running a program check out the Shooting Sports Webpage for updates to this program guide and find other resources.

For questions or additional information, contact the National Service Center at [shootingsports@scouting.org](mailto:shootingsports@scouting.org).



## SAMPLE PERMISSION FORM

### Scouting Participation and Hold-Harmless Agreement

\_\_\_\_\_ (Unit, District or Council) is conducting a shooting sports program. Scouts will be instructed how to handle, maintain, and shoot a shotgun safely and be provided instruction to increase their shooting skills. Scouts will have classroom instruction and range instruction in which they will fire a shotgun under the supervision of a trained Range Safety Officer and NRA certified Shotgun Instructor.

Scouts will be required to wear eye protection and hearing protection always while on the range. Scouts are expected to abide by all safety rules and the instructions of the Range Safety Officer(s) and Shotgun Instructor(s).

I, the undersigned, give my child, \_\_\_\_\_, permission to participate

in this program. I understand that participation in the activity involves a certain degree of risk. I have carefully considered the risk involved and have given consent for my child to participate in the activity. I understand that participation in the activity is entirely voluntary and requires participants to abide by the rules and standards of conduct. I release the Boy Scouts of America, the local council, the activity coordinators, and all employees, volunteers, related parties, or other organizations associated with the activity from all claims or liability arising out of this participation. For safety, my child and I agree that they will do the following or they will be removed from the program. I understand that any additional cost associated with participation in this program will not be refunded if my child is removed due to behavioral problems.

1. Complete the training offered as part of the program.
2. Wear all safety gear always while on the range.
3. Follow all safety rules provided in the training class.
4. Follow the instructions of the Range Safety Officer(s) and Shotgun Instructor(s).
5. Do not handle any shotguns until instructed to do so by the Shotgun Instructor(s).
6. Follow the instructions of the Range Safety Officer(s) always.
7. Is a registered Scouts BSA member, Venturer, or Sea Scout

Participant signature \_\_\_\_\_ Date: \_\_\_\_\_

Parent/guardian signature \_\_\_\_\_ Date: \_\_\_\_\_

Parent/guardian printed name \_\_\_\_\_ Date: \_\_\_\_\_

Home phone \_\_\_\_\_ Cell phone \_\_\_\_\_





# APPENDIX 18 - OPEN SHOTGUN SHOOTING EXPERIENCE

## For Scouts BSA Members, Venturers And Sea Scouts

### INTRODUCTION

This guide is intended to provide units, districts and councils with an overview of the requirements for running the shooting program ensuring all BSA Policies are followed under NRA Certified Shotgun Instructor and Range Safety Officer (RSO). In this publication, you will find youth requirements, training requirements for adults who are providing the program for camp and weekend program venues. The program offers a fun and safe introduction to safe handling of a shotgun.

### PROGRAM GUIDELINES

#### Youth Requirements

Registered Scouts BSA members, Venturers or Sea Scouts, and youth who are age-appropriate participating in a Council, District or Unit organized Shotgun Shooting activity conducted as part of a recruiting event. All youth participants are required to have written permission from their parent or guardian before they can take part in the program. A sample permission form is included in the back of this guide. The council may also include this as part of the overall permissions for the camp or activity; however, it must clearly state that a youth has the parent or guardian's permission to handle and fire a firearm.



### STANDARD OPERATING PROCEDURES

The standard operating procedures (SOPs) of the range should also be reviewed by NRA Range Safety Officer before delivering this program. All firearms must be approved for use by the NRA Range Safety Officer.

### THE RANGE

An approved range can include:

- BSA Range
- Public Range
- Private Range
- Commercial range
- Private Property Range.

Public, private property or commercial ranges must be certified using the application found here:

[Click here](#) or type this address in browser

<https://www.scouting.org/outdoor-programs/shooting-sports/permission/>

### ADULT SUPERVISION AND TRAINING REQUIREMENTS

1. BSA Youth Protection policies for two deep leadership must be maintained at all times.
2. Instructors must have current certification from the NRA as a Instructor
3. RSO must have current certification from the NRA as a Range Safety Officer (RSO).

### APPLICABLE LAWS

BSA safety policies generally run parallel to or go beyond legal mandates. However, it is the camp or activity supervisor's responsibility to confirm and ensure compliance with all applicable federal, state, and local regulations or statutes related to youth handling and using a firearm.





## SHOTGUN OPEN SHOOTING EXPERIENCE

**Purpose:** To provide shooters with Knowledge, Skill and Attitude (KSA) necessary to shoot a shotgun safely under supervision of a certified instructor.

**Examples:** Unit, District, or Council organized program which could include; a day-at-the-range event (fun shoot), recruiting new members, Winchester/NRA Marksmanship Qualification Program, camporee, camp weekend shoot, or Order of the Arrow event are examples.

**Youth:** Scouts BSA members, Venturers, Sea Scouts

**Shotgun:** Youth & adult-size 12 or 20 gauge gas-operated semi-automatic shotguns recommended.

**Ammunition:** Correct ammunition for the shotgun being fired. Light loads of shot size #7 or smaller is recommended. **Reloaded ammunition is not approved for BSA programs.**

**Training:** The BSA Safety Shotgun Briefing presented by an NRA Range Safety Officer. The Range Safety Rules are posted and reviewed during the briefing.

**Safety:** ANSI Z87.1-2010 certified eye protection and hearing protection is required.

**Range supervision:** An NRA Range Safety Officer is to directly supervise all live fire on the range. Additionally, the instruction must be done by a currently certified NRA Shotgun Instructor. These must be two separate individuals.

**Ratio:** One NRA Range Safety Officer must be present for each group consisting of a maximum of six shooters. One NRA certified Shotgun Instructor is required for each active shooter. At the discretion of the instructor, loading may be completed by the student or the instructor.

**There is not a policy in the BSA that requires the NRA Instructor to load the firearm.**

Below are examples of range commands assuming 1 inexperienced shooter with 1 instructor, using a single trap with a single presentation of target. The actual commands to use should be based on the course of fire, the circumstances and the number of shooting positions.

## Range Commands

- Command: "Eye and ear protection on."
- Command: "Move forward to your shooting position."
- Command: "Practice mounting and following a target with the gun."
- Command: "Load and prepare to fire."
- Command: "Is the trapper ready?"
- Command: "Call "Pull" when shooter is ready."

Continue until shooter has completed the course of fire.

- Command: "Cease fire."
- Command: "Range is clear."
- Command: "You may exit the shooting area."
- Command: "Remove eye and ear protection."

## BEFORE THE YOUTH ARE ON THE RANGE

All shotguns, ammunition, and targets are provisioned during non-program times by maintenance and support personnel in sufficient quantity to run the program for all shooters without interruption.

## ON THE RANGE

- Eye and ear protection should be cleaned between each shooter.
- Range staff will assist the RSO and Instructor by loading the trap, preparing shotguns, ammunition to the preparation table, and setting up shooting positions on range.
- General staging areas for shooters and those waiting their turn are clearly marked and safe gun handling rules posted.

**People in program areas adjacent to the firing line must wear ear protection if measured sound levels are 85 dba or above.**

## WHEN YOUTH ARE PRESENT IN THE PROGRAM AREA

Welcome youth to the area and begin the gun handling safety briefing. Range Safety Officer(RSO) is responsible for all activities on the range.

## RANGE INSPECTION CHECKLIST

Inspected by \_\_\_\_\_ Date \_\_\_\_\_

√ = Yes

\_\_\_ Controlled access/fencing/gates closed

\_\_\_ Flags or signs displayed

\_\_\_ Range limits identified

\_\_\_ Backstop/impact area inspected

\_\_\_ Ready line/area marked

\_\_\_ Spectator area designated

\_\_\_ Supplies available

\_\_\_ First-aid kit filled/accessible

\_\_\_ Range rules posted

\_\_\_ Bulletin board available

\_\_\_ Shotgun racks available

\_\_\_ Empty trash receptacles available

\_\_\_ Lockable storage

\_\_\_ Throwers available and loaded

\_\_\_ Eye and ear protection available

\_\_\_ Hand washing Station Available

## Range Safety Briefing – Shotgun

- No Ammunition in the classroom!
- To provide shooters with Knowledge, Skill and Attitude (KSA) necessary to shoot a shotgun safely under supervision of a certified instructor.
- 3 Rules of Gun Safety
  - Always keep your gun pointed in a safe direction
  - Always keep your finger off the trigger until ready to shoot
  - Always keep your gun unloaded until ready to us.
- Parts of a shotgun
- Demonstrate shotgun operation
  - Loading dummy rounds
  - Cocking
  - Dry Fire
  - Unloading
- Shooting Fundamentals
  - Determine Eye Dominance
  - Stance
  - Hold Point
  - Mount
  - See the target
  - Swing
  - Pull the trigger
  - Follow through
  - The most important - Focus on the target
- Range Layout
  - Ready Area
  - Firing Line
  - Target Area
  - Back Stop
- Other Safety Rules
  - Know your target and what is beyond
  - Eye and Ear Protection
  - No alcohol or drugs
  - Proper hygiene
  - Clean up after shooting

- Range Commands
  - Command: “Eye and ear protection on.”
  - Command: “Move forward to your shooting position.”
  - Command: “Practice mounting and following a target with the gun.”
  - Command: “Load and prepare to fire.”
  - Command: “Is the trapper ready?”
  - Command: “Call “Pull” when shooter is ready.”

Continue until shooter has completed the course of fire.

- Command: “Cease fire.”
- Command: “Range is clear.”
- Command: “You may exit the shooting area.”
- Command: “Remove eye and ear protection.”

Before running a program check out the Shooting Sports Webpage for updates to this program guide and find other resources.

For questions or additional information, contact the National Service Center at [shootingsports@Scouting.org](mailto:shootingsports@Scouting.org)

## SAMPLE PERMISSION FORM

### Scouting Participation and Hold-Harmless Agreement

\_\_\_\_\_ (Unit, District or Council) is conducting a shooting sports program. Scouts will be instructed how to handle, maintain, and shoot a shotgun safely and be provided instruction to increase their shooting skills. Scouts will have classroom instruction and range instruction in which they will fire a shotgun under the supervision of a trained Range Safety Officer and NRA certified Shotgun Instructor.

Scouts will be required to wear eye protection and hearing protection always while on the range. Scouts are expected to abide by all safety rules and the instructions of the Range Safety Officer(s) and Shotgun Instructor(s).

I, the undersigned, give my child, \_\_\_\_\_, permission to participate

in this program. I understand that participation in the activity involves a certain degree of risk. I have carefully considered the risk involved and have given consent for my child to participate in the activity. I understand that participation in the activity is entirely voluntary and requires participants to abide by the rules and standards of conduct. I release the Boy Scouts of America, the local council, the activity coordinators, and all employees, volunteers, related parties, or other organizations associated with the activity from all claims or liability arising out of this participation. For safety, my child and I agree that they will do the following or they will be removed from the program. I understand that any additional cost associated with participation in this program will not be refunded if my child is removed due to behavioral problems.

1. Complete the training offered as part of the program.
2. Wear all safety gear always while on the range.
3. Follow all safety rules provided in the training class.
4. Follow all the instructions of the Range Safety Officer(s) and Shotgun Instructor(s).
5. Do not handle any shotguns until instructed to do so by the Shotgun Instructor(s).
6. Follow the instructions of the Range Safety Officer(s) always.
7. Is a registered Scouts BSA member, Venturer, or Sea Scout

Participant signature \_\_\_\_\_ Date: \_\_\_\_\_

Parent/guardian signature \_\_\_\_\_ Date: \_\_\_\_\_

Parent/guardian printed name \_\_\_\_\_ Date: \_\_\_\_\_

Home phone \_\_\_\_\_ Cell phone \_\_\_\_\_



## APPENDIX 19 - SPORTING ARROWS

### Archery Range Considerations for Laporte's Bowtrap System

The following parameters of the program and site requirements must be followed as outlined in order to execute the program correctly. At this time, the only equipment to be used with the Laporte Bowtrap System is a bow with a maximum of a 26-pound pull and the Laporte proprietary safety arrows, or "Fluflu Arrows."

**Purpose & Scope:** This Design Guideline will address the basic parameters of the range or area that will be used for sporting arrows. "Sporting Arrows" was introduced to the Scouting community at the 2014 National Scout Jamboree. This is a program is only for Scouts BSA members, Venturers and Sea Scouts. This is a new archery game where Scouts fire at foam disk that are launched in the air or rolled along the ground by a proprietary "Bowtrap" manufactured by Laporte <https://www.laporte.biz/en-us/archery/>.



This Design Guideline is based on the use of a maximum of a 26-pound bow with Laporte's proprietary safety arrows, or "Flu-flu Arrows", and winds of 30 miles per hour or less. Laporte's proprietary safety arrows, or "Flu-flu Arrows", are design to be used with these foam targets and have a maximum range of 190 feet (see Drawing No. 1).

**Fall Areas:** Because archers will be shooting at various angles, a 180 degree safety area, referred to as a fall area shall be fenced or marked in such a way to prevent people from accidentally walking into the sporting arrow range. The majority of the arrows will fall in the primary fall area, a 90 degree area centered in front of the shooters. This area should be clear of trees to ensure safety and help with the recovery of the arrows. It is permissible to have trees or other tall vegetation in the side fall areas, but they should be cleared if possible. The perimeter of this fall area shall be clearly marked. This could be permanent fence or a temporary fence/caution line. Permanent and temporary fences should be clearly marked and labeled to prevent people from accidentally walking on the range. Temporary fences should be installed in such a way that it will survive a weekend of activity and weather.

**Supervisory Personnel:** There should be a ratio of 1 Level I Archery instructor supervising up to 3 shooters on the range. Only 3 shooters allowed at one time on the range per Design Guideline 316 found at <https://www.scouting.org/outdoor-programs/properties/resources/design-guidelines/>. The Level I Archery instructor must be a minimum of 18 years old. This applies to year-round use of the sporting arrows program, both summer resident and year-round camping. Starting in the fall of 2016, the Level I instructor must also take a module showing how the program works to be qualified.

If a council is in need of locating a Level I Archery instructor, there is a USA Archery website which lists who they are and where they are in the country. At this site, you can also find where the training opportunities are offered to get this certification.

Go to: <http://www.teamusa.org/USA-Archery/Coaching/Find-an-Instructor-or-Coach>

**References:** When setting up the range plan to include firing lines, waiting lines, benches, range flag and other features similar to the BSA 10 Yard range as illustrated on page 3 of Design Guideline 313 – Archery Ranges.

- Design Guideline 313 – Archery Ranges – Boy Scouts of America
- National Shooting Sports Manual – Boy Scouts of America

Authorized Participation: To conduct these programs, councils need to complete an application and submit it for approval to the Outdoor Programs/Properties Department by email to [shootingsports@scouting.org](mailto:shootingsports@scouting.org)

For questions or additional information, contact the National Service Center at [shootingsports@scouting.org](mailto:shootingsports@scouting.org)

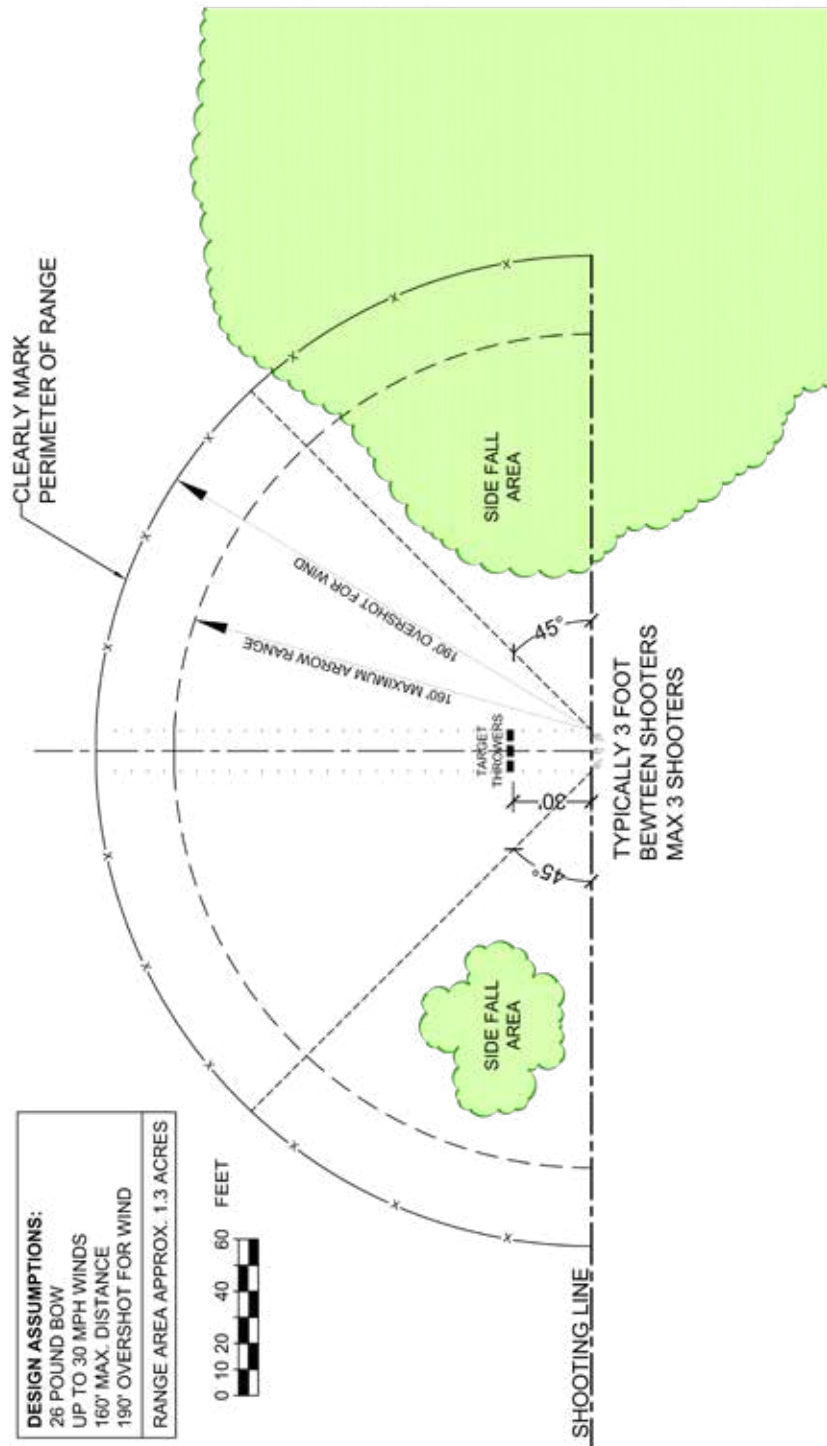



## APPENDIX 20 - CUB SCOUT SHOOTING SPORTS GUIDE

### A Guide to the Cub Scout Shooting Sports Awards for Unit Leaders, Councils, Districts, and Range Masters

#### A WORD ABOUT YOUTH PROTECTION

Child abuse is a serious problem in our society and, unfortunately, it can occur anywhere, even in Scouting. Because youth safety is of paramount importance to Scouting, the Boy Scouts of America continues to strengthen barriers to abuse through its policies and leadership practices; through education and awareness for youth, parents, and leaders; and through top-level management attention to any reported incidents.

#### KEY TO SUCCESS: LEADERSHIP EDUCATION AND TRAINING

Registered leaders are required to complete Youth Protection training within 30 days of registering.

Parents, guardians, and any adults working with youth (whether in Scouting or not) are also encouraged to take the training.

To take the training online, go to [www.myscouting.org](http://www.myscouting.org) and establish an account. If you do not yet have your membership number, be sure to return to MyScouting later and enter your number for training record credit.

**The training must be taken every two years to remain current.** If a volunteer does not meet the BSA's Youth Protection training requirement at the time of recharter, the volunteer will not be reregistered.

#### BSA YOUTH PROTECTION TRAINING

The BSA created Youth Protection training to address the needs of different age groups as follows.

- **Youth Protection Training for Volunteer Leaders and Parents** — Adults come away with a much clearer awareness of the kinds of abuse, the signs of abuse, and how to respond and report should a situation arise.

- **Youth Protection Guidelines: Training for Adult Venturing Leaders** — Designed to give guidance to the leaders in our teenage coed Venturing program. Supervision and relationship issues have a different focus regarding personal safety with this age group.
- **It Happened to Me** — Developed for Cub Scout-age boys and girls from 6 to 10 years old and their parents. It addresses the four rules of personal safety: Check first, go with a friend, it's your body, and tell.
- **A Time to Tell** — A video for Scouts BSA-age boys and girls from 11 to 14 years old — the target group for most molesters. It stresses the three R's of Youth Protection: Recognize, Resist, and Report.
- **Personal Safety Awareness for Venturing** — Developed for youth ages 13 through 20 in the coeducational Venturing program. It deals with issues pertinent to this age group.

The BSA has Youth Protection policies to protect youth, and these same policies help protect adult volunteers. These and other key policies are addressed in the training:

- Two-deep leadership is required on all outings.
- One-on-one contact between adults and youth members is prohibited.
- Privacy of youth is respected.
- Separate accommodations for adults and Scouts are required.
- Units are responsible for enforcing Youth Protection policies.

To find out more about the Youth Protection policies of the BSA and how to help Scouting keep your family safe, see the *Guide to Safe Scouting* at [www.scouting.org/HealthandSafety/GSS/toc.aspx](http://www.scouting.org/HealthandSafety/GSS/toc.aspx) and the Parent's Guide in any of the Cub Scouting or Scouts BSA handbooks, or go to [www.scouting.org/Training/YouthProtection.aspx](http://www.scouting.org/Training/YouthProtection.aspx).

## PREFACE

Cub Scout shooting sports programs may be conducted only on a district or council level. Archery, BB gun shooting, and slingshot shooting are restricted to day camps, Cub Scout/Webelos Scout resident camps, council-managed family camping programs, or council activities where there are properly trained supervisors and where all standards for BSA shooting sports are enforced. All shooting ranges in the Cub Scout program must be supervised by a qualified Rangemaster who is at least 18 years of age and meets the minimum requirements. See specific qualifications and training requirements for Cub Scout shooting sports Rangemasters in the *Boy Scouts of America National Shooting Sports Manual*, No. 430-938.

## USING THIS GUIDE

- Archery, BB gun shooting, and slingshot shooting are not approved unit activities.
- The use of pellet air rifles is restricted to Webelos Scouts in a Boy Scouts of America resident camp setting only.
- Kindergarten–age youth in the Lion program may participate in Cub Scout archery or slingshot activities.
- **The Multi-Gun Airsoft Experience introduced in August 2015 was not designed for participation in this award. Airsoft guns are not approved for use in the Cub Scout shooting sports program.**
- **All local, state, and federal laws for BB guns, archery, and slingshot shooting must be followed.**

This *Cub Scout Shooting Sports Guide* is intended to assist leaders in helping their Cub Scouts earn the shooting sports awards. It is not a substitute for authorized Rangemaster training or for the safety procedures called out in the *Boy Scouts of America® National Shooting Sports Manual*, No. 430-938, which is the reference for any shooting sports activities in the Boy Scouts of America.

All volunteers participating in official Scouting activities should become familiar with the *Guide to Safe Scouting*. The Guide to Safe Scouting may be found online at [www.scouting.org/scoutsourc/HealthandSafety/GSS](http://www.scouting.org/scoutsourc/HealthandSafety/GSS).



## CONTENTS

### Section 1

- 205 **Introduction**
- 205 Purpose of the Cub Scout Shooting Sports Awards
- 205 Structure of the Cub Scout Shooting Sports Awards

### Section 2

- 207 **Award Requirements and Explanations**
- 207 BB Gun
- 212 Archery
- 219 Slingshot

### Appendix

- 223 **Resources for the Cub Scout Shooting Sports Awards**
- 223 Posters
- 242 Additional Activities

## SECTION 1: INTRODUCTION

The goal of the *Cub Scout Shooting Sports Guide* is to support shooting sports directors, Rangemasters, on-range adult volunteers, and unit leaders as they assist Cub Scouts in meeting the requirements of the Cub Scout shooting sports awards according to Boy Scouts of America policy and practice. This resource supports — but does not replace — the *Boy Scouts of America National Shooting Sports Manual* (No. 430-938).

The Cub Scouting shooting sports disciplines of archery, BB gun shooting, and slingshot shooting are restricted to day camps, Cub Scout/Webelos Scout resident camps, council-managed family camping programs, or council activities held on or off BSA property where there are current and properly trained BSA shooting sports Rangemasters and where all standards for BSA shooting sports are enforced.

### Purpose of the Cub Scout Shooting Sports Awards

As decades of Cub Scouting have shown, most youth love to shoot!

Beyond capturing that enthusiasm, the BSA created the Cub Scout Shooting Sports Awards program to encourage in Cub Scouts the development of safe shooting practices and proficiency in shooting sports. As Cub Scouts participate in shooting sports activities and work toward an award, they not only build confidence

in their abilities, but also develop self-reliance, sportsmanship, and conservation awareness — all elements of good character valued in Scouting.

Through experiential learning guided by a knowledgeable adult, Cub Scouts will learn the safe and responsible use of BB guns, slingshots, and archery equipment. The goal is for the Cub Scout to have fun in a safe environment, not to become an expert marksman, Rangemaster, or hunter.

### Lions, Tigers and Shooting Sports

Lions and their adult partners may participate in archery or slingshot shooting sports activities. Tigers and their adult partners may participate in all Cub Scouting shooting sports activities. The adult partners must be included in all shooting activities. Each Lion/Tiger must be paired with their adult partner before being allowed to shoot. In most cases, Lions/Tigers and their adult partners will participate in shooting sports activities at a day camp.

Keep in mind that youth of this age have very short attention spans (20 to 30 minutes, maximum) and tire easily. They probably have little experience working as a group and may require more time to understand how the range operates. Lions/Tigers have a wide range of ability and experience levels, so be ready for anything!

### Structure of the Cub Scout Shooting Sports Awards

Cub Scout shooting sports awards may be earned for any of the three following disciplines:

- Archery
- BB guns (available only for Tiger through Arrow of Light ranks.)
- Slingshots

A Cub Scout may choose to participate in only one of the disciplines or may choose to participate in all three disciplines. The requirements for each of the disciplines are structured similarly.

**Level 1** involves participation in a discipline and acquiring basic knowledge of proper technique, safety, and operations in that discipline.

**Level 2** is designed to help a Cub Scout develop and demonstrate further skills, proficiency, and knowledge in a shooting discipline. Level 2 requirements are rank-specific and provide a progression of skills appropriate to each age and rank of Cub Scouting.

## Earning the Awards

Cub Scouts earn the shooting sports awards in the following order:

- 1. Rank-level patch.** Choose a discipline: BB gun, archery, or slingshot. Complete the level 1 requirements for that discipline. The patch is awarded only once per program (rank) year.
- 2. Discipline device (pin).** Complete the level 2 requirements for the same discipline in which the patch was earned.
- 3. Additional discipline devices.** Earn pins for the remaining disciplines by completing the level 1 and level 2 requirements in those disciplines. (NOTE: Requirements for both level 1 and level 2 must be completed for each successive discipline.)

**Disciplines:** BB gun, archery, slingshot

**Program years/ranks:** Lion, Tiger, Wolf, Bear, Webelos/Arrow of Light

### Sample situation:

A new Tiger completes the level 1 requirements for BB guns and earns the Tiger shooting sports patch at a day camp in the district. The Scout later attends another day camp and completes the level 2 requirements and earns the BB gun pin to attach to the patch. Later that year, the district holds a Cub Scout shooting sports day at the local park. This time the Cub Scout completes both the level 1 and level 2 for archery. He or she earns the archery pin, which will be worn on the Tiger shooting sports patch.

**See section 2 for more information on awards and requirements.**

## Shooting Sports Awards

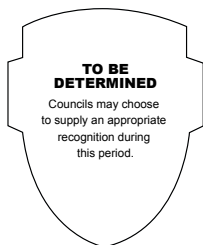

LION



TIGER



WOLF



BEAR



WEBELOS

## Shooting Sports Award Pins

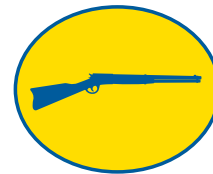
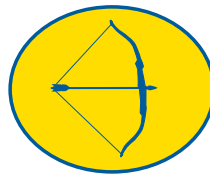

## SECTION 2: AWARD REQUIREMENTS AND EXPLANATIONS

### BB GUN LEVEL 1 REQUIREMENTS

#### Level 1: Participation and Knowledge – ALL RANKS (Lions are not approved for BB guns)

1. Explain what you should do if you find a gun. Recite the four safety reminders.

2. On an approved range in your city or state, explain how to use the safety mechanism, and demonstrate how to properly load, fire, and secure the BB gun.

3. On an approved range, demonstrate to qualified leadership good shooting techniques, including eye dominance, shooting shoulder, breathing, sight alignment, trigger squeeze, and follow-through.

4. On an approved range, show how to put away and properly store BB gun shooting equipment after use.

### TRAINING CUB SCOUTS

The objectives of this award are to teach Cub Scouts how to use a BB gun safely, to teach basic BB gun shooting skills, and to have fun. Cub Scouts should have the opportunity to fire a BB gun during the first orientation period. This activity is not intended to produce expert marksmen.

The instructor must always be mindful of his or her responsibility to make safety thoroughly understood before, during, and after instruction and practice. At the same time, he or she must have warmth, patience, and understanding for the Scout who finds the skill difficult to learn.

#### Teaching tips

The coach-pupil method is effective for all types of skill training and is particularly effective in shooting sports. To put this method into practice:

- Put the BB gun in the Cub Scout's hand as soon as possible so he or she can understand the BB gun while the basics are explained.
- Group participants into pairs (Scout and parent/guardian would be ideal).
- The instructor demonstrates the activity or action to be followed before the whole group. When demonstrating techniques, be sure to do them correctly.
- The instructor then circulates among the pairs, giving a word of advice or assistance, recognizing good work, correcting errors, and determining how well the participants understood the method.
- The Scout practices while the parent coaches. Let

Scouts shoot the first round. At a predetermined signal, reverse the roles. Progressively, participants are learning by observing, by doing, and by coaching.

- Use a positive approach. Use praise sincerely. Before making a correction, question the fault to find the cause. Do show a Scout what they might be doing wrong.
- Avoid long discussions on the parts of the equipment used. Teach just enough so participants will know how to safely use the equipment.
- Allow each Scout to feel the satisfaction of hitting a target as quickly as possible.

### NOTES ON BB GUN LEVEL 1 REQUIREMENTS

#### Level 1, Requirement 1

*Explain what you should do if you find a gun. Recite the four safety reminders.*

This requirement should be reviewed while the Scouts are preparing for their turn on the range or in a pre-event activity. A lively chant will help them memorize the reminders.

#### The Four Safety Reminders

What should you do if you find a gun?



**STOP!**



**LEAVE THE AREA!**



**DON'T TOUCH!**



**TELL AN ADULT!**

#### Level 1, Requirement 2

*On an approved range in your city or state, explain how to use the safety mechanism, and demonstrate how to properly load, fire, and secure the BB gun.*

#### Safety Guidelines

When training youth to shoot, be sure to have proper equipment, secure and safe ranges, and clear safety instruction.

Gun safety is a simple but continuous process. Youth must first learn about safe gun handling. Safe handling skills are developed through practice. The most important safety element is attitude. All the safety knowledge and skills are of little value unless they are used. Being safe means consciously keeping a BB gun under control.



Before handling any gun, a Scout must always get permission from his or her parent or guardian. If this is their first BB gun shooting experience, the Scout should sit down with an adult and discuss under what circumstances the gun can be handled. They must understand that the BB gun is not a toy.

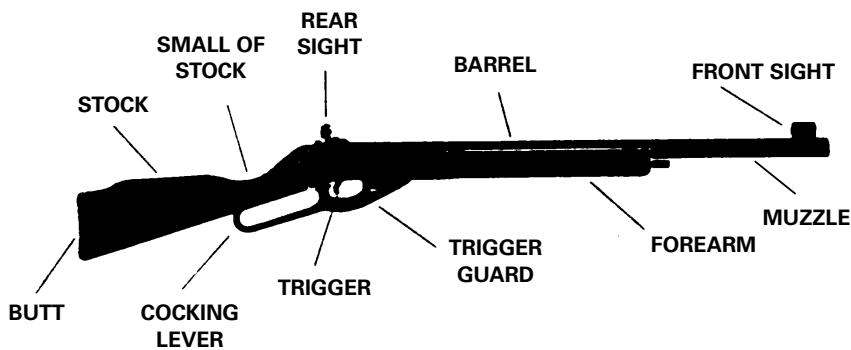

The following basic rules apply to handling a BB gun under any circumstances. Also review any applicable local, state, and federal laws, and be sure to follow them on your range.

1. **Always keep the gun pointed in a safe direction.** This is the primary rule of gun safety. “Safe direction” means that the gun is pointed so that even if it were to go off, it would not cause injury or damage. The key to this rule is to control where the muzzle or front end of the barrel is pointed at all times. Common sense dictates the safest direction depending on circumstances.
2. **Always keep your finger off the trigger until you are ready to shoot.** When holding a gun, rest your finger along the side of the gun or the trigger guard. Until you are actually ready to fire, do not touch the trigger.
3. **Always keep the gun unloaded until ready to use.** When you pick up a gun, carefully point it in a safe direction. Check to be certain the safety is on, and if not, engage the safety if possible. Then, while keeping your finger off the trigger, open the action and look inside the chamber(s) to make sure it is clear of ammunition. If the gun has a magazine, remove it before opening the action and make sure it is empty. If you do not know how to open the action or inspect the chamber(s), leave the gun alone and get help from someone who does.
4. **Know how to use a gun safely.** Before handling a gun, learn how it operates. Know its basic parts and how to safely open and close the action. Know how to remove ammunition from the gun or magazine.
5. **Be sure the gun is safe to operate.** Just like other tools, guns need regular maintenance to remain in good working order. Regular cleaning and proper storage are part of the gun’s general upkeep. If there is any question about a gun’s ability to function, then do not use it. Get someone to fix it!
6. **Use only the correct ammunition for the gun.** Only the BB designed for a particular BB gun can be

fired safely in that gun. Do not shoot the gun without loading the proper ammunition.

7. **Wear eye protection.** Always wear eye protection. Shooters and instructors should wear approved safety goggles at all BB gun ranges. BBs might ricochet.

8. **Don’t rely on the safety.** Most guns have a mechanism called a “safety” that helps to prevent the gun from accidentally firing. However, a safety is a mechanical device, which can—and will—fail. Shooters must be trained that the safety mechanism is not a sure, safe way to prevent a gun from firing. Many accidents have occurred because shooters have relied on the safety mechanism to work.

9. **Wear ear protection.** Although not mandatory for BB gun shooting, ear protection may also be worn. Shots fired from guns are loud and the noise could damage the hearing of some shooters.

10. **Know your target and what is beyond the target.** Be absolutely sure to identify the target beyond any doubt. Equally important, be aware of the area beyond the target. Never fire in a direction where there are people or where any other potential for mishap might exist. Think first. Shoot second.

11. **Store guns so they are not accessible to any unauthorized person.** Deciding where and how to store guns and ammunition depends on several factors, including security and accessibility. Safe and secure storage means that untrained individuals (especially children) are denied access to guns and ammunition.

### Level 1, Requirement 3

*On an approved range, demonstrate to qualified leadership good shooting techniques, including eye dominance, shooting shoulder, breathing, sight alignment, trigger squeeze, and follow-through.*

NOTE: The following activities can be taught in advance at a pre-event meeting or during a separate session.

#### Eye Dominance

Before shooting a gun, the participants should determine which eye is dominant. Just as people are either right- or left-handed, one eye is more dominant than the other. Discovering which eye a shooter favors is important because it could determine on which side the gun is held.



To find which eye is dominant, have participants extend both arms in front of them and form a small hole with their thumbs and index fingers. Instruct

them to look at a distant object through the opening and then pull their hands back to their face. The eye that is in line with the object is dominant.

### Shooting Shoulder

It is recommended that a shooter use the shoulder that is on the same side of the body as the dominant eye. If the right eye is dominant, place the firearm against the right shoulder. If the left eye is dominant, use the left shoulder. If the shooter has learned to use the opposite shoulder and eye, it may be more comfortable for them to shoot that way.

### Breathing

When shooting, stop breathing before firing a shot. Breathing causes the body to move and makes it difficult to maintain a steady sight picture. Before firing, relax and get comfortable. Then exhale and stop breathing. This technique will help shooters aim by reducing the body and rifle movement in relation to the target. Do not stop breathing for longer than 8 to 10 seconds while aiming at the target. If you are not able to shoot within that time, stop, take a breath or two, and repeat the process.

### Sight Alignment

The shooter must learn proper sight alignment. This is the relationship of the front and rear sights to the eye. The shooter's dominant eye must be lined up with the front and rear sights, and the sights must be positioned so that the front sight device is aligned properly with the rear sight.

### Trigger Squeeze

“Trigger squeeze” is the term used to explain the manner in which pressure is applied to the trigger. Some other terms commonly used are “trigger pull”, “trigger control”, “trigger press”, and “trigger movement”. While all of these terms are correct, the preferred term is “trigger squeeze” because it accurately describes the smooth application of pressure required.

When ready to begin squeezing the trigger, the index finger should be located on the trigger so that the trigger is about halfway between the tip of the finger and the first joint.

The trigger must be squeezed straight back in a smooth, continuous manner without disturbing the sight alignment. Once trigger squeeze has begun, keep squeezing smoothly and continuously; do not speed up, slow down, or apply pressure in a start-and-stop manner. Use the same type of pressure that would be used to squeeze a drop of liquid from a medicine dropper—a gradual, steady application of pressure until the drop finally falls. Just as it would be impossible to predict the instant that the drop of liquid will fall, it should be impossible to predict the precise instant that the gun will fire. Each shot should come as a surprise.

For best results, trigger squeeze and sight alignment must be done simultaneously.

### Follow-Through

The shooter must also master proper follow-through. Follow-through means to continue to do everything that was being done at the time the shot was fired. In other words, keep aiming until the BB hits the target.

The idea is to prevent any unnecessary movement before the projectile leaves the barrel. Because an air gun takes longer to send a projectile out of the barrel, proper follow-through is particularly important.

### Level 1, Requirement 4

*On an approved range, show how to put away and properly store BB gun shooting equipment after use.*

- Work with your range master according to local practices and procedures. In most cases:
  - The BB gun should be unloaded.
  - The safety mechanism should be engaged.
  - The BB gun should be protected from scratches and scrapes from other guns.
  - The BB gun should be locked or otherwise secured in a safe place.

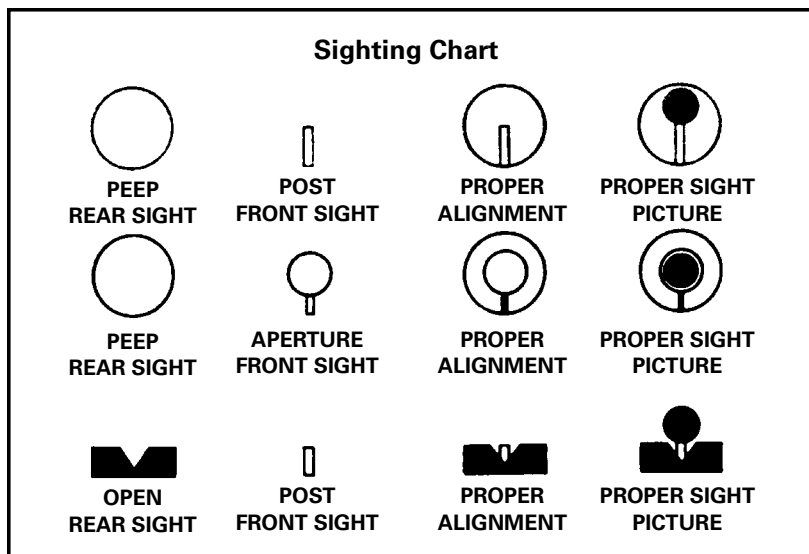

Proper sight alignment is a key to accurate shooting. Any misalignment of the front sight with the rear sight introduces an angular error that is multiplied with distance.

A correct sight picture is obtained by achieving the proper alignment and then putting the aligned sights into their proper relationship with the target.



## Level 2: Skill and Knowledge

To earn the Level 2 Skill and Knowledge recognition, Cub Scouts must complete the Level 1 Participation and Knowledge requirements, and do the following:

- Tigers must complete S1–S3 from the Tiger column.
- Wolves and Bears must complete S1–S4 from the Wolf/Bear column.
- Webelos and Arrow of Light Scouts must complete S1–S4 from the Webelos/Arrow of Light column.

	Tiger	Wolf/Bear	Webelos/Arrow of Light
S1	Demonstrate one of the positions associated with shooting BB guns.	Demonstrate one of the positions associated with shooting BB guns.	Demonstrate the prone, bench, and sitting positions associated with shooting BB guns.
S2	On an approved range, fire five BBs at the "TIGER" target. Score your target; then repeat and do your best to improve your score. (Fire a total of 10 BBs.)	On an approved range, fire five BBs at the "CUB SCOUT" target. Score your target; then repeat twice and do your best to improve your score each time. (Fire a total of 15 BBs.)	On an approved range, fire five BBs at the "WEBELOS/AOL" target. Score your target; then repeat three times and do your best to improve your score. (Fire a total of 20 BBs.)
S3	Demonstrate proper range commands, and explain how and when to use them.	Demonstrate proper range commands, and explain how and when to use them.	Demonstrate proper range commands, and explain how and when to use them.
S4		Tell five facts about the history of BB guns.	Tell five facts about the history of BB guns.

## BB GUN LEVEL 2 REQUIREMENTS

### NOTES ON BB GUN LEVEL 2 REQUIREMENTS

#### Level 2, Requirement S1: Shooting Positions

Decide with input from your range master the best method and order for accomplishing this requirement.

#### Shooting Positions

Proper body position is essential to achieve a good shooting score. When learning any shooting position, these basic steps must be followed:

1. Study the position.
2. Practice the position without a gun. (Learn to put the feet, legs, body, head, and arms in the correct position without holding a gun.)
3. Practice the position with a gun.
4. Align the position properly with the target. Adjust the position so that the gun points naturally at the target.
5. Shoot from the position.



PRONE POSITION



SITTING POSITION



BENCHREST POSITION



FREE-ARM STANDING POSITION

## Level 2, Requirement S2

**Tiger:** On an approved range, fire five BBs at the “TIGER” target. Score your target; then repeat and do your best to improve your score. (Fire a total of 10 BBs.)

**Wolf/Bear:** On an approved range, fire five BBs at the “CUB SCOUT” target. Score your target; then repeat twice and do your best to improve your score each time. (Fire a total of 15 BBs.)

**Webelos/Arrow of Light:** On an approved range, fire five BBs at the “WEBELOS/AOL” target. Score your target; then repeat three times and do your best to improve your score. (Fire a total of 20 BBs.)

Leaders assisting with this requirement should keep in mind the Cub Scout motto, “Do Your Best,” at all times. The goal is for the Cub Scout to improve their technique and, as a result, improve their overall performance. There is NO specific score required for this requirement, only improvement. This may mean five misses the first time, and one hit on the target the second time. While it is clearly desired that the Scout would improve to the point of scoring an actual target, and while it would be good to work to that goal if time allows, the requirement only requires improvement.

Using the designated target for each Cub Scout rank allows Scouts of all ages the opportunity to reach an appropriate proficiency level. There are three targets for BB guns, as shown below.

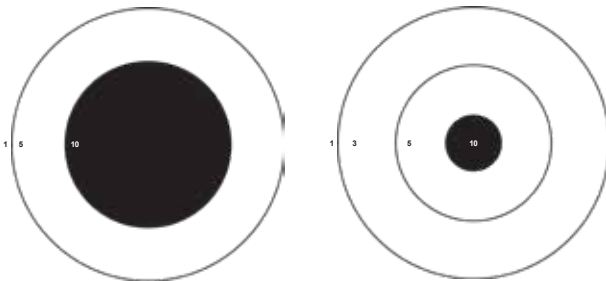

**TIGER TARGET**

**WOLF/BEAR TARGET**

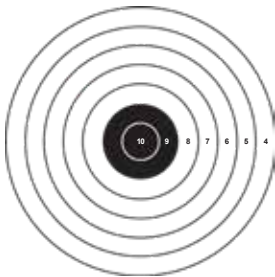

**WEBELOS/ARROW OF LIGHT TARGET**

These targets are included for reproduction purposes in the poster section of the appendix. Each Cub Scout should use the appropriate target for their rank. When reproducing the targets, choose a paper color that contrasts with the background coloring to make “hits” easier to spot.

## Level 2, Requirement S3

Demonstrate proper range commands, and explain how and when to use them.

Safety is critical at your event. The actual commands should be taught, and the Scouts should quiz each other until they acquire a thorough knowledge level. See the appendix for some common range commands, but confirm with your range master the actual commands and their meanings on your range.

### SUGGESTED BB GUN RANGE COMMANDS

<b>LOAD</b>	<b>Load your BB gun.</b>
<b>READY ON THE FIRING LINE</b>	<b>All shooters are ready.</b>
<b>COMMENCE FIRING</b>	<b>You may fire your BB gun.</b>
<b>CEASE FIRING</b>	<b>Stop shooting.</b>
<b>CLEAR ALL GUNS</b>	<b>Show your BB gun is empty. Lay it down.</b>

## Level 2, Requirement S4

Tell five facts about the history of BB guns.

Using the material in this guide or another source, help the Cub Scouts learn about BB guns and their history.

### A Brief History of BB Guns

In ancient history, blowguns began to appear in many different parts of the world. Although crude, these primitive weapons were very accurate. They were made from bamboo or other hollowed-out woods. A blowgun is a tube into which a hunter blows to shoot a projectile out the other end. This idea was transferred into gun form sometime in the 1500s. The bellows gun, invented around 1580, is the earliest known air-powered gun.

A few decades later, the first pneumatic (pump-up) air gun was created in France for King Henry IV. The nobility usually owned these early guns, since they were too expensive for commoners.

In the late 1700s, some units of the Austrian army were equipped with air rifles.

In America, records show that in the 1800s, Lewis and Clark had an air gun for hunting and for impressing the American Indians. The American Indians called it “the smokeless thunder stick.”

In 1885, in the United States, the Markham Air Rifle Company became one of the first companies to sell BB guns. These pneumatic rifles eliminated bullets and

used a small pellet the size of a ball bearing, soon to be called a “BB.”

A few years later, a company that sold steel windmills decided to also sell BB rifles. By 1895, this company had stopped producing windmills and made air rifles full-time and changed the company name to Daisy.

Daisy’s guns were mostly made of steel, which improved the gun’s strength and design. The Daisy air rifle became popular very quickly, and within five years Daisy had sold 250,000 BB guns. Soon, Daisy bought out all of its competition.

Daisy also promoted to youth by making special BB guns associated with popular historical characters like Davy Crockett.

In 1984, the Olympic Games featured air guns for the first time.

Today, BB guns are still being produced in both rifle and pistol forms and are very popular among all age groups.

## ARCHERY LEVEL 1 REQUIREMENTS

<b>Level 1: Participation and Knowledge (ALL RANKS)</b>
1. Demonstrate how to follow archery range safety rules and whistle commands.
2. Identify and name a recurve bow and/or compound bow.
3. Explain and demonstrate how to apply and use arm guards, finger tabs, and quivers.
4. On an approved range, demonstrate how to safely and effectively shoot a bow and arrow, including how to establish a correct stance, nock the arrow, hook and grip the bow, raise the bow, draw, anchor, hold, aim, and release/follow through.
5. On an approved range, demonstrate how to safely retrieve arrows after the range is clear and the command to retrieve arrows has been provided.

## NOTES ON ARCHERY LEVEL 1, REQUIREMENT 1

This requirement may be taught in advance of the shooting experience at a pre-event meeting or additional program station in a camp setting. **Be sure to use the actual rules and commands or whistle codes your range will use!**

## Archery Range Rules and Commands

### ARCHERY RANGE RULES

1. Always walk on the range
2. Keep your arrows in your quiver until you are told to shoot.
3. Only release the bow string when an arrow is nocked and safely pointed toward the target.
4. Leave dropped arrows on the ground until instructed to retrieve them.

**If there is an emergency on the range, immediately tell the instructor.**

### KNOW THE PROPER WHISTLE CODES

**TWO BLASTS** = Move up to the line.

**ONE BLAST** = Fire the proper number of arrows.

**THREE BLASTS** = Cease firing. Move to the target. Retrieve and score arrows.

**FIVE OR MORE WHISTLE BLASTS** = Cease firing. Stay where you are. This is an EMERGENCY. Officials will tell the archers what action to take either verbally or by the whistle code.

Remember there is only ONE command to shoot — ONE blast of the whistle.

For any command of more than one blast, STOP shooting. Watch and listen for further instructions.

(From USAA Archery Certification Course — Level 1 manual. Used with permission.)

### Level 1, Requirement 1:

*Demonstrate how to follow archery range safety rules and whistle commands.*

Lions or Tigers with their adult partners, and Wolf, Bear, and Webelos Scouts should learn these simple safety rules. When training youth to shoot, be sure to have proper equipment, secure and safe ranges, and clear safety instruction.

### Safety Rules for Archers

1. Observe all state and local laws on using a bow and arrow.
2. Shoot only with proper range supervision.
3. Always check your equipment before shooting. Break and discard all cracked or fractured arrows.
4. Be sure to include all of the safety guidelines and the proper whistle codes.
5. Bows and arrows should be used only in places set aside for their use.

6. Always keep your arrows pointed down or toward the target.
7. Only release an arrow when you can see its full clear path to the target.
8. Shoot only at the target in front of you.
9. Keep the arrows in the quiver until everyone is on or behind the shooting line and the range master has indicated that you may begin shooting.
10. Archers stand with both feet behind the line.
11. Stop shooting immediately upon signal from the range master or if anyone crosses in front of the shooting line or in front of or behind the targets.
12. Use only arrows that have been measured for your proper draw length. Arrows that are too short may cause personal injury or damage to the bow and arrow.
13. Always wear an arm guard and finger tab or glove.
14. Always practice courtesy and good sportsmanship.
15. Always walk, never run, when on the archery range or while carrying arrows.
16. On a target range, leave the bow standing against the target face while you are looking for lost arrows.
17. Stay on marked paths. Travel the direction in which the targets are marked.

### Safety Rules for Rangemasters

1. **Know** where arrows will go if the target is missed and to ensure a safety zone is in place.
2. **Lock, secure, and affix signs** to all access gates and entranceways downrange of the shooting line to inform people of the activity.
3. **Communicate** with range officers and other camp personnel regarding when and where archery activities will take place.
4. **Avoid shooting into the sun.**
5. **Know how many arrows the archers have** before shooting to be sure they are all retrieved.
6. **Clear the range** of any potential tripping hazards.

*(From USAA Archery Certification Course – Level 1 manual. Used with permission.)*

### Level 1, Requirement 2:

Identify and name a recurve bow and/or compound bow.

The two bows most commonly used by Cub Scouts are

- **Recurve:** Recurve bows are the traditional bow for learners. It allows the archer to better learn proper finger tension. Modern recurve bows are either made

entirely of fiberglass, or are a composite of wood and fiberglass. Both options are satisfactory for beginning instruction.

- **Compound:** Compound bows are generally harder to master, but they will produce more consistent results. The pulley system provides a mechanical advantage to assist where strength or stamina is an issue.

### Types of Archery Bows

#### RECURVE BOW

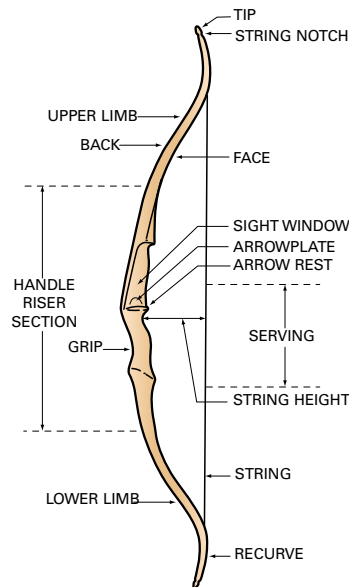

#### COMPOUND BOW

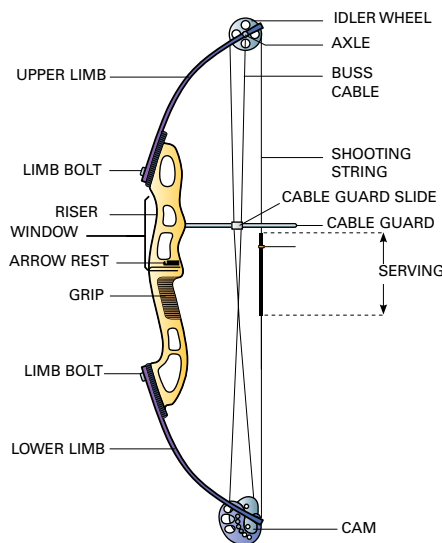

**All archers should be able to identify a recurve bow and compound bow. If your range uses only one type, obtain an example of the other for identification purposes to meet the requirement.**

### Level 1, Requirement 3:

*Explain and demonstrate how to apply and use arm guards, finger tabs, and quivers.*

Use the safety equipment available at your range, and demonstrate how to wear and adjust it properly. This should include arm guards, finger tabs, arrows, and quivers. Depending on the size of your shooters, you may need to adjust which equipment can be used safely. Be sure to cover loose and oversized shirts, jackets, or other items that may constitute a hazard when shooting arrows.



#### Arm Guards

An arm guard is a piece of stiff material, usually leather or nylon, that attaches to the inside of the forearm of the archer's bow arm to protect it from the bowstring upon release. It also holds down jacket and shirt sleeves so they don't interfere with the bowstring's travel. The larger part goes toward the elbow. A right-handed archer should wear the guard on the left arm, a left-handed archer on the right arm.

**Every shooter must use an arm guard and finger protector.**

#### Care of Arm Guards

Arm guards should have laces or elastic replaced when needed. Arm guards should be kept in labeled boxes. All leather goods will last longer if stored in a cool, dry place and occasionally cleaned with saddle soap.

#### Finger Tabs

Finger tabs are preferable to gloves for group instruction because they present fewer fitting problems. Made of smooth leather, finger tabs absorb the friction of the bowstring across the fingertips. Without them, painful blisters can develop. Many designs are available, but for beginners the simplest and most inexpensive type is satisfactory.

#### Quivers

For the young beginner, having a quiver to use when returning arrows from the target to the shooting line will improve safety procedures.

### Level 1, Requirement 4:

*On an approved range, demonstrate how to safely and effectively shoot a bow and arrow, including how to establish a correct stance, nock the arrow, hook and grip the bow, raise the bow, draw, anchor, hold, aim, and release/follow through.*

#### Step 1: STANCE

Stance is the correct foot position of the archer. The goal is to provide a solid foundation for the shot. An archer is most stable in an open stance.

1. Stand with both feet behind the shooting line.
2. Feet should be shoulder-width apart.
3. Move the foot closest to the target back about 3 inches.
4. Turn the toes of both feet toward the target about 30 degrees.

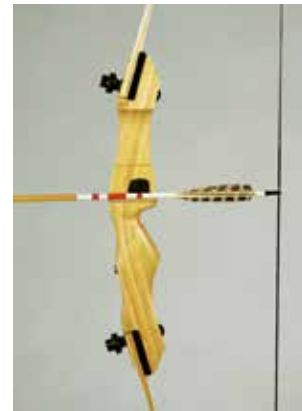

#### Step 2: Nock the Arrow

To nock an arrow is to securely place the arrow onto a bowstring. When the arrow is securely placed on the bowstring, the archer feels and/or hears the arrow "snap" into place.

1. Grasp the arrow below the nock.
2. Bring the arrow up and over the bow and place it on the arrow rest.
3. Spin the arrow so the index vane (usually a different color) points away from the riser and toward the archer's body.
4. Push the nock into place on the bowstring directly below the nocking point.

#### Step 3: Hook and Grip

Archers touch the bow in only two places: the bowstring where they "hook" it, and at the grip where they "grip" it. *Hook* is when an archer curls three fingers around the bowstring directly beneath the arrow. The grip on a bow is where the archer places his or her hand on the bow.





1. Curl the bowstring with the fingertips of the index, middle, and ring fingers under the arrow.
2. Pull the bowstring back enough to apply a small amount of tension.
3. Center the meaty part of the thumb on the back of the bow grip.
4. Point the thumb toward the target and angle your knuckles 45 degrees. Check to be sure the grip is relaxed.

#### Step 4: Raise the Bow

This step gives the archer the opportunity to confirm that all previous steps have been completed before proceeding. Once that is done, do the following:

1. Turn the head toward the target.
2. Rotate the elbow of the bow arm away from the bowstring.
3. Lift both arms to shoulder height.
4. Extend the bow arm fully, keeping the bow vertical.

The archer raises the bow in preparation for drawing back the bowstring. This gives the archer a sense of direction by knowing where the bow is in relation to the target. While raising the bow, it is important to keep the rest of the body still.

#### Step 5: Draw

Pull the bowstring back toward the face. The draw should be seamless and smooth.

#### Step 6: Anchor

The archer should pull the bowstring back to a consistent anchor point every time to maintain accuracy. For beginning archers, the corner of the mouth is the preferred anchor point.

1. Settle the index finger of the draw hand into the corner of the mouth.
2. Keep the draw hand relaxed and up against the face.

#### Step 7: Hold

Move the draw arm elbow slightly behind the arrow to brace the draw weight of the bow. The tension of holding the bow is now transferred from the shoulder and arm muscles to the back muscles.



#### Step 8: Aim

Aim is lining up the arrow to the target. Simply put, the arrow will go where it is pointed. The goal is to focus equally on the target and the arrow point.

1. Place the point of the arrow on the intended target area.
2. The eye focus is equally on the arrow point and the target.

#### Step 9: Release/Follow-Through

Release occurs when the archer relaxes the tips of the fingers that are hooking the bowstring, allowing the bowstring to push the fingers out of the way. Follow-through is the finish position.

1. Relax the fingertips to allow the bowstring to push the fingers out of the way.
2. Keep the bow arm up.
3. Finish the shot by allowing the draw hand to fall between the ear and the shoulder.

**Refer to the Archery Shooting Form poster, found on page XX of the appendix.**

#### Level 1, Requirement 5:

*On an approved range, demonstrate how to safely retrieve arrows after the range is clear and the command to retrieve arrows has been provided.*



## Retrieve Arrows

After all archers have shot their allotment of arrows (usually around six, if time permits), demonstrate and explain the proper methods to retrieve arrows from the target and ground.

First, before any archer goes to retrieve any arrows, permission must be granted by the range officer. The range officer will observe the archers and indicate when all archers have completed shooting and it is safe to retrieve arrows.

1. Follow the proper commands to move to the target line. Archers should walk slowly to the target and watch for arrows on the ground.
2. Remove arrows by standing to the side of the target and brace it with the side of the body. Place one hand on the target at the base of the arrow.
3. Grasp the arrow near the target and pull firmly and slowly straight back toward the shooting line.
4. Place the arrow on the ground.
5. Remove any others and place them on the ground.
6. After all the arrows have been removed, pick up the arrows from the ground. Cover the points with one hand and grasp the arrows near the fletching with the other hand. An arrow buried under the grass should be withdrawn point first and be completely clear of the grass before the arrow is lifted.
7. Walk back to the shooting line and place the arrows into the ground quiver.
8. Move off the range, or prepare to resume shooting, as commanded.

## ARCHERY LEVEL 2 REQUIREMENTS

<b>Level 2: Skill and Knowledge</b>					
To earn the Level 2 Skill and Knowledge recognition, all Cub Scouts must complete the Level 1 Participation and Knowledge requirements, and do the following:					
<ul style="list-style-type: none"> <li>• Lions must complete S2–S3 from the Lion column.</li> <li>• Tigers must complete S1–S3 from the Tiger column.</li> <li>• Wolves must complete S1–S4 from the Wolf column.</li> <li>• Bears must complete S1–S4 from the Bear column.</li> <li>• Webelos and Arrow of Light Scouts must complete S1–S4 from the Webelos/Arrow of Light column.</li> </ul>					
	<b>Lion</b>	<b>Tiger</b>	<b>Wolf</b>	<b>Bear</b>	<b>Webelos/Arrow of Light</b>
S1		Identify three parts of the arrow and three major parts of the bow you will be shooting.	Identify three parts of the arrow and four major parts of the bow you will be shooting.	Identify four parts of the arrow and five major parts of the bow you will be shooting.	Identify five parts of the arrow and six major parts of the bow you will be shooting.
S2	Shoot at least two arrows at a target on an approved range; repeat and do your best to improve your score. (Shoot at least four arrows.)	Shoot three arrows at a target on an approved range; then repeat and do your best to improve your score. (Shoot a total of six arrows.)	Shoot five arrows at a target on an approved range; then repeat and do your best to improve your score. (Shoot a total of 10 arrows.)	Shoot five arrows at a target on an approved range; then repeat twice and do your best to improve your score each time. (Shoot a total of 15 arrows.)	Shoot five arrows at a target on an approved range; then repeat three times and do your best to improve your score each time. (Shoot a total of 20 arrows.)
S3	Demonstrate proper range commands, and explain how and when to use them.	Demonstrate proper range commands, and explain how and when to use them.	Demonstrate proper range commands, and explain how and when to use them.	Demonstrate proper range commands, and explain how and when to use them.	Demonstrate proper range commands, and explain how and when to use them.
S4			Tell five facts about archery in history or literature.	Tell five facts about archery in history or literature.	Tell five facts about archery in history or literature.



## NOTES ON ARCHERY LEVEL 2 REQUIREMENTS

### Level 2, Requirement S1: Parts of the Bow and Arrow

Review the parts of a bow and arrow with Cub Scouts. Determine that each Cub Scout has identified the number of parts needed to meet the requirement for his or her rank.

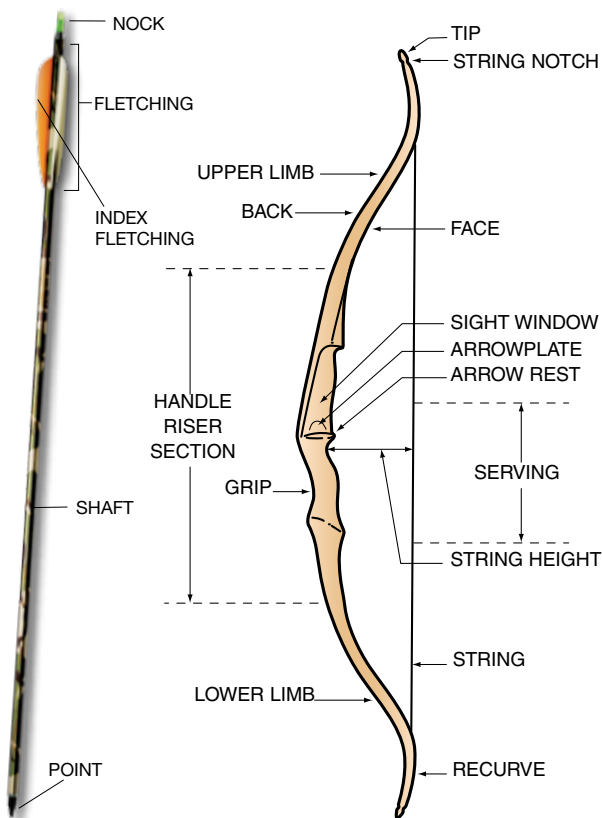

**Arrow:** A shaft made of carbon, aluminum, wood, fiberglass, or composite materials with a point on one end and a nock on the other end. Fletching, which can be either feathers or plastic vanes, are located on the arrow near the nock end

**Field point:** Similar to a target point and has a distinct shoulder, so that missed outdoor shots are easier to remove from obstacles such as tree stumps

**Fletching:** The stabilizing feathers or vanes of an arrow

**Index fletch or vane:** A different-colored fletch or vane used to indicate proper arrow positioning in relation to the bowstring or bow

**Nock:** The plastic attachment or grooved notch at the end of an arrow used to attach the arrow to the bowstring

**Shaft:** The main structural element of an arrow

**Target Point:** Attaches to the front end of an arrow and penetrates the target

### Level 2, Requirement S2

**Lion:** Shoot at least two arrows at a target on an approved range; repeat and do your best to improve your score. (Shoot at least four arrows.)

**Tiger:** Shoot three arrows at a target on an approved range; then repeat and do your best to improve your score. (Shoot a total of six arrows.)

**Wolf:** Shoot five arrows at a target on an approved range; then repeat and do your best to improve your score. (Shoot a total of 10 arrows.)

**Bear:** Shoot five arrows at a target on an approved range; then repeat twice and do your best to improve your score each time. (Shoot a total of 15 arrows.)

**Webelos/Arrow of Light:** Shoot five arrows at a target on an approved range; then repeat three times and do your best to improve your score each time. (Shoot a total of 20 arrows.)

Leaders assisting with this requirement should keep in mind the Cub Scout motto, “Do Your Best,” at all times. The goal is for the Cub Scout to improve his or her technique and, as a result, improve their overall performance. There is NO specific score required for this requirement, only improvement. This may mean five misses the first time, and one hit on a hay bale the second time. While it is clearly desired that the Cub Scout would improve to the point of scoring an actual target and, if there is adequate time, it would be good to work to that goal, the requirement only requires improvement.

**Cub Scout-level target scoring should be kept simple. For Tigers, it may be just hitting the hay bale or a large piece of paper on the bale. As the archers progress in skill, move to more structured scoring methods.**

### Level 2, Requirement S3

*Demonstrate proper range commands, and explain how and when to use them.*

This requirement is to be completed once for the level 1 award, and again for the level 2 award, according to the commands and rules practiced on your approved range.

With assistance from your Rangemaster, determine which range commands will be used. This may mean special archery whistle codes, or just a version of the BB gun range commands, depending on your location. This requirement could be partially accomplished off the firing line for instruction and then demonstrated on the firing line.

### Level 2, Requirement S4

*Tell five facts about archery in history or literature.*

Using the material in this guide or another source, help the Cub Scouts learn about archery in history or literature.

## A Brief History of Archery

The advancement of civilization was enhanced by the use and discovery of bows and arrows. The bow and arrow provided a much safer way to hunt and made life easier.

Generally it is thought the spear was the predecessor to the bow. Spearheads have been discovered from many thousands of years ago.

A recognizable bow was discovered dating back to 6000 B.C. that was made from yew or elm.

Egyptians, sometime around 3500 B.C. to 2800 B.C., were the first to use the bow in battle, which gave them superiority over their enemies. This bow was known as a composite bow.

Around 1500 B.C., Assyrians developed a shorter recurve bow that provided more power and easier handling. Crossbows were also used in ancient China, but not until many years later.

Around 1200 B.C., a famous Egyptian pharaoh named Ramses II gave archery another boost by putting archers on chariots. This mobility allowed the Egyptians to defeat the Hittite army.

Through the course of history, the wooden bow was made longer. The British were famous for improving on

the bow, which eventually became known as the British longbow. The most famous battle of the longbow was the battle of Crécy in 1346. In 1500, crossbows were banned in England to promote the use of the longbow. In 1595, the army was ordered to replace all bows with muskets. Still, archery has remained a popular sport in England.

Around 1000 A.D., bow and arrow technology swept the Americas. As seen through archeological studies, its use was adopted by most prehistoric Native Americans.

In 1879 the National Archery Association was founded. The first national tournament was held in White Stocking Park, Chicago, Illinois, that same year. The first archery club in the U.S., the United Bowmen of Philadelphia, was founded in 1928.

In 1900, archery became an Olympic sport, but it was dropped after 1920 because the rules could not be standardized. In 1931, the Fédération Internationale de Tir à l'Arc (FITA) was founded in Paris, and it standardized the rules for international competition. Archery returned to the Olympics in 1972 and is still part of the Olympic program. USA Archery is the sanctioning body in the United States for archery events.



## SLINGSHOT LEVEL 1 REQUIREMENTS

### Level 1: Participation and Knowledge (ALL RANKS)

1. On an approved range, demonstrate to qualified leadership good shooting techniques, including eye dominance, breathing, sight alignment, and follow-through.
2. On an approved range, explain the parts of a slingshot and demonstrate how to properly use them.
3. Explain the different types of ammunition that may be used with a slingshot and those that may not be used.
4. Explain the different types of targets that may be used with a slingshot and those that may not be used.

### NOTES ON SLINGSHOT LEVEL 1 REQUIREMENTS

The preferred slingshot for Cub Scouts has a wrist brace so the shooter's hand doesn't become weak from having to hold the frame tightly.

Using slingshots is an affordable, fun activity in council-sponsored camps. Youth love to shoot slingshots, and many have not had previous experience with them.

Although exciting and fun, slingshots are not toys. Scouts must understand that they must follow the rules when shooting slingshots or they will not be allowed to participate.

Shooting items from slingshots can be dangerous. For these activities, follow the same safety guidelines as used for BB shooting. Always shoot at a range such as an archery or BB gun range.

**CAUTION: Slingshot bands contain natural rubber latex. Those who are allergic to rubber latex should not use slingshots. Allergic reactions such as skin rashes, hives, or nasal, eye, or sinus symptoms may occur.**

**Slingshot ranges, equipment, and safe practices must follow the guidelines spelled out in the *National Shooting Sports Manual*. Generally, the same rules apply for this activity that would apply for BB gun shooting.**

#### Level 1, Requirement 1:

*On an approved range, demonstrate to qualified leadership good shooting techniques, including eye dominance, breathing, sight alignment, and follow-through.*

#### Good Shooting Techniques

(Instructions are for right-handed shooters. Reverse instructions for left-handed shooters where applicable.)

1. A Rangemaster must be present and there must be a one-to-one adult-to-Scout ratio.
2. Use a safe shooting range such as a BB gun range or archery range.
3. Wear protective eyeglasses or goggles.
4. Do not pick up a slingshot until told to do so.
5. Never shoot at anything if you cannot see what is behind it.
6. Do not use a slingshot with a power band damaged by age or weather.
7. Never shoot up into the air.
8. Never cross the firing line when shooting.
9. Point your left foot and shoulder directly at the target with the body turned to the right. Turn the head directly toward the target.
10. Center the ammo in the middle of the leather pouch. Hold the handle firmly in the left hand and pinch the ends of the leather pouch together with the thumb and index finger of the right hand, encompassing the ammo.
11. Hold the left arm out straight and firm. Draw the right hand back level with the right cheek — NEVER TO THE EYE — while holding the leather pouch securely between the thumb and index finger of the right hand.
12. Aim and release the leather ammo pouch to shoot.
13. Always practice courtesy and good sportsmanship!

#### Eye Dominance

Before shooting a slingshot, the participants should determine which eye is dominant. Just as people are either right- or left-handed, one eye is dominant over the other. Discovering which eye a shooter favors is important because it could determine on which side the slingshot is held.

To find which eye is dominant, have participants extend both arms in front of them and form a small triangle with their thumbs and index fingers. Instruct them to look at a distant object through the opening and then pull their hands back to their face. The eye that is in line with the object is dominant. (See page XXX in the appendix.)

#### Breathing

When shooting, stop breathing before firing a shot. Breathing causes the body to move and makes it difficult to maintain a steady sight picture. Before firing, relax and get comfortable. Then exhale and stop breathing. This technique will help shooters aim by reducing the body and slingshot movement in relation to the target. Do not stop breathing for longer than 8 to 10 seconds while aiming at the target. If you are not able to shoot within that time, stop, take a breath or two, and

repeat the process. The pouch of the slingshots should be pulled all the way back to your cheek and released as you breathe out.

### **Aiming: Sight Alignment**

To aim a slingshot, hold it horizontally and aim with the upper fork end. To shoot correctly, the ammo will need to be centered inside the slingshot pouch. You will also need to make sure that the slingshot handle is parallel to the ground and that the fork is 90 degrees to the upright position.

### **Follow-Through**

The shooter must also master proper follow-through. Follow-through means continuing to do everything that was being done at the time the shot was fired. In other words, maintaining aim until the ammunition shot from the pouch of the slingshot hits the target. The idea is to prevent any unnecessary movement before the projectile leaves the pouch.

**See the Slingshot Range Rules poster on page 238 of the appendix.**

### **Level 1, Requirement 2:**

On an approved range, explain the parts of a slingshot and demonstrate how to properly use them.

#### **Slingshot Parts**

**Hand grip and forks.** These form the basic slingshot design. The hand grip can be customized as needed. The forks are made of sturdy metal or other material which will not bend.

**Wrist brace.** The wrist brace attaches to the basic slingshot and is used to stabilize the shooting platform and provide more leverage for the shooter to apply power.

**Bands.** Bands are usually made of latex surgical tubing, which stretches to propel ammunition.

**Pouch.** The pouch holds ammunition, usually made of leather or other sturdy material.

### **Level 1, Requirement 3:**

*Explain the different types of ammunition that may be used with a slingshot and those that may not be used.*

Items shot from slingshots are considered ammunition. Generally people use small rocks or pebbles; however, this is not appropriate for Cub Scouts. Instead, use softer ammunition such as pinto beans or dog food. Ammunition such as ball bearings may not be used.

### **Level 1, Requirement 4:**

*Explain the different types of targets that may be used with a slingshot and those that may not be used.*

#### **Targets**

Targets for slingshots can be made from a variety of materials, including paper, cans, plastic bottles, and balloons. Paper targets can be homemade or purchased. Cans are excellent as they make a great sound when hit. Cans, plastic bottles, and balloons can be hung from strings or attached to netting. Remember to recycle when finished.

You can also practice using a slingshot on a bull's-eye target about 2 inches in diameter and with the target 10 feet away; then move the target out to 25 feet.





## SLINGSHOT LEVEL 2 REQUIREMENTS

### Level 2: Skill and Knowledge

To earn the Level 2 Skill and Knowledge recognition, all Cub Scouts must complete the Level 1 Participation and Knowledge requirements, and do the following:

- Lions must complete S1–S2 from the Lion column.
- Tigers must complete S1–S3 from the Tiger column.
- Wolves must complete S1–S3 from the Wolf column.
- Bears must complete S1–S3 from the Bear column.
- Webelos and Arrow of Light Scouts must complete S1–S3 from the Webelos/Arrow of Light column.

	Lion	Tiger	Wolf	Bear	Webelos/Arrow of Light
S1	On an approved range, shoot two shots at a target; then repeat and do your best to improve your score. (Shoot a total of four shots.)	On an approved range, shoot three shots at a target; then repeat and do your best to improve your score. (Shoot a total of six shots.)	On an approved range, shoot five shots at a target; then repeat and do your best to improve your score. (Shoot a total of 10 shots.)	On an approved range, shoot five shots at a target; then repeat twice and do your best to improve your score each time. (Shoot a total of 15 shots.)	On an approved range, shoot five shots at a target; then repeat three times and do your best to improve your score each time. (Shoot a total of 20 shots.)
S2	Demonstrate proper range commands and explain how and when to use them.	Demonstrate proper range commands and explain how and when to use them.	Demonstrate proper range commands and explain how and when to use them.	Demonstrate proper range commands and explain how and when to use them.	Demonstrate proper range commands and explain how and when to use them.
S3		On an approved range, try shooting with your non-dominant hand.	On an approved range, try shooting with your non-dominant hand.	On an approved range, try shooting with your non-dominant hand.	On an approved range, try shooting with your non-dominant hand.

### NOTES ON SLINGSHOT LEVEL 2 REQUIREMENTS

#### Level 2, Requirement S1

**Lion:** *On an approved range, shoot two shots at a target; then repeat and do your best to improve your score. (Shoot a total of four shots.)*

**Tiger:** *On an approved range, shoot three shots at a target; then repeat and do your best to improve your score. (Shoot a total of six shots.)*

**Wolf:** *On an approved range, shoot five shots at a target; then repeat and do your best to improve your score. (Shoot a total of 10 shots.)*

**Bear:** *On an approved range, shoot five shots at a target; then repeat twice and do your best to improve your score each time. (Shoot a total of 15 shots.)*

**Webelos/Arrow of Light:** *On an approved range, shoot five shots at a target; then repeat three times and do your best to improve your score each time. (Shoot a total of 20 shots.)*

Leaders assisting with this requirement should keep in mind the Cub Scout motto, “Do Your Best,” at all times. The goal is for the Cub Scout to improve their technique

and, as a result, improve their overall performance.

There is NO specific score required for this requirement, only improvement. This may mean five misses the first time, and one hit on a target the second time. While it is clearly desired that the Cub Scout would improve to the point of scoring an actual target and, if there is adequate time, it would be good to work to that goal, the requirement only requires improvement.



## Level 2, Requirement S2

*Demonstrate proper range commands and explain how and when to use them.*

Generally, these will be the same as BB gun range commands. Consult with your range master to determine existing range commands, or develop the actual commands used on the range.

### **GENERAL SLINGSHOT RANGE COMMANDS**

**LOAD** = Load your slingshot.

**READY ON THE FIRING LINE** = All participants are ready.

**COMMENCE FIRING** = You may fire your slingshot.

**CEASE FIRING** = Stop shooting

## Level 2, Requirement S3 (Tiger, Wolf, Bear, Webelos only)

*On an approved range, try shooting with your non-dominant hand.*

Firing a slingshot requires strength in the hand holding the grip and strength in the hand holding the pouch. Both hands play a role in proper aiming of the slingshot. You may find that switching hands helps with coordination or accuracy and may even help you determine which is your dominant eye. This requirement will be completed once an honest attempt has been made; there is no measurement for accuracy or scoring.

## APPENDIX 1: POSTERS

- 223 General Shooting Range Rules
- 224 Eye Dominance
- 225 BB Gun Sighting Chart
- 226 Parts of a BB Gun
- 227 If You Find a Gun
- 228 Suggested BB Gun Range Commands
- 229 Suggested BB Gun Safety Rules
- 230 BB Gun Shooting Positions
- 231 BB Gun Targets
- 234 Archery Range Rules and Commands
- 235 Archery Shooting Form
- 236 Types of Archery Bows
- 237 General Slingshot Range Commands
- 238 General Slingshot Range Rules
- 239 Slingshot Safety Rules
- 240 Parts of a Slingshot
- 241 Cub Scout Shooting Sports Tracking Template

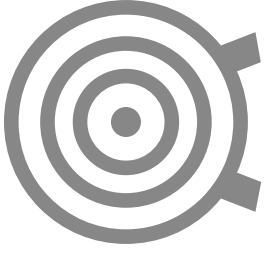

# GENERAL SHOOTING RANGE RULES

1. This range may be opened only by a qualified BSA-certified range master.
2. All commands issued by the range master must be obeyed immediately.
3. Stay behind the firing line. Do not straddle the firing line.
4. Do not pick up a gun, bow, arrow, or slingshot unless told to by the range master.
5. Absolutely no running on the range.
6. No horseplay or unnecessary talking on the range.
7. If in doubt about the rules, ask your leader or range master for advice or help.





# EYE DOMINANCE

Eye dominance is the unconscious preference to use one eye rather than the other to aim. The dominant eye often corresponds with the archer's dominant hand, but not always. There are a number of people who are "cross dominant," meaning they may be right-hand dominant and left-eye dominant, or vice versa.

It is important to understand how to determine eye dominance in the event a shooter or archer is struggling to aim or hit the target consistently. Eye dominance needs to be addressed when a shooter or archer is shooting with their dominant hand, but trying to aim with their opposite dominant eye. They may try to line up their dominant eye to the target by tipping their head over the bow or gun, causing their shots to be consistently left or right of center on the target.

## **To Find the Dominant Eye**

To find which eye is dominant, have participants extend both arms in front of them and form a small hole with their thumbs and index fingers. Instruct them to look at a distant object through the opening and then pull their hands back to their face. The eye that is in line with the object is dominant.

**Important Note: It is not necessary to make a Cub Scout who is cross dominant shoot with the non-dominant hand. The shooter may simply choose to continue shooting with the dominant hand and cover or close the non-dominant eye.**





# BB GUN SIGHTING CHART

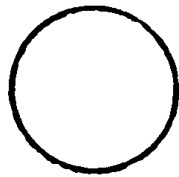

PEEP  
REAR SIGHT

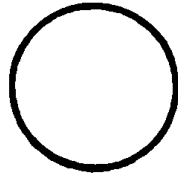

PEEP  
REAR SIGHT



OPEN  
REAR SIGHT



POST  
FRONT SIGHT



APERTURE  
FRONT SIGHT



POST  
FRONT SIGHT

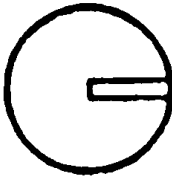

PROPER  
ALIGNMENT

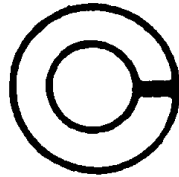

PROPER  
ALIGNMENT



PROPER  
ALIGNMENT

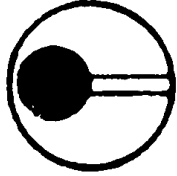

PROPER SIGHT  
PICTURE



PROPER SIGHT  
PICTURE



PROPER SIGHT  
PICTURE



# PARTS OF A BB GUN

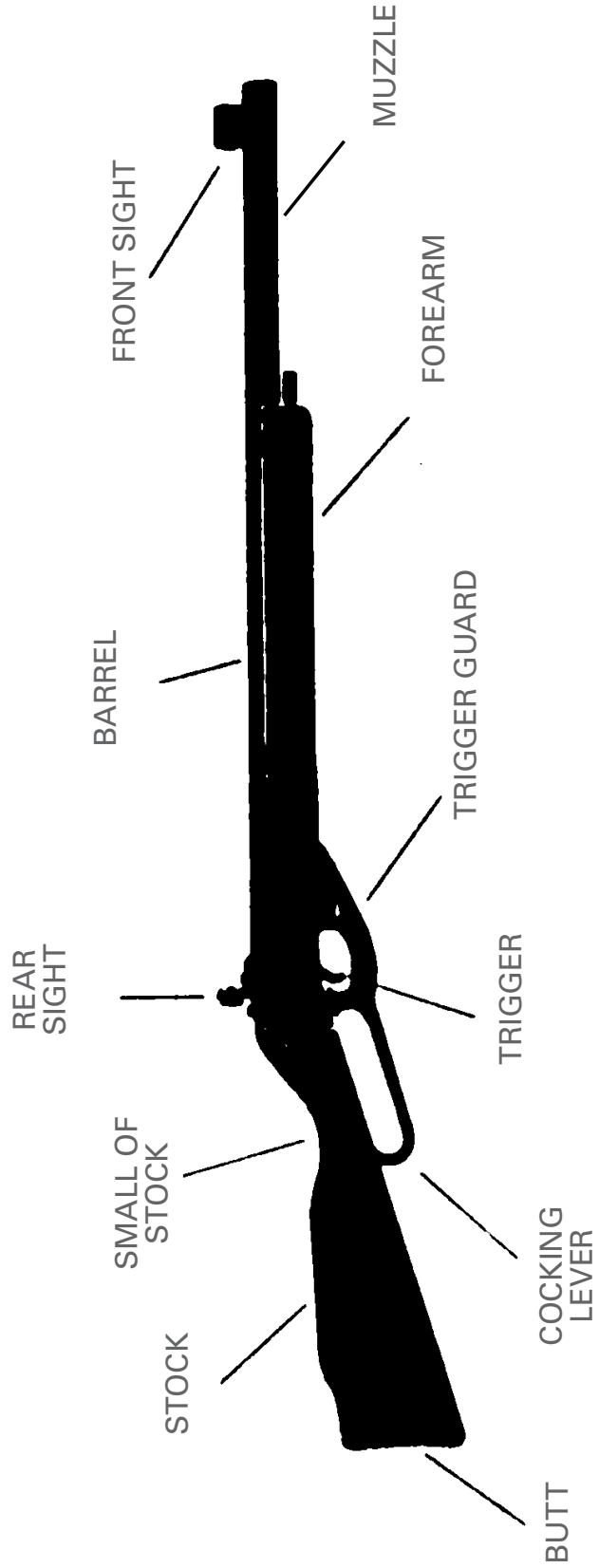



**IF YOU FIND A GUN**

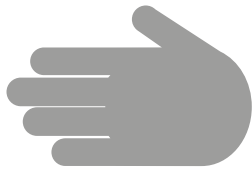

**STOP!**



**LEAVE THE AREA!**



**DON'T TOUCH!**



**TELL AN ADULT!**



# SUGGESTED BB GUN RANGE COMMANDS

---

<b>LOAD.</b>	<b>LOAD YOUR BB GUN.</b>
<b>READY ON THE FIRING LINE.</b>	<b>ALL SHOOTERS ARE READY.</b>
<b>COMMENCE FIRING.</b>	<b>YOU MAY FIRE YOUR BB GUN.</b>
<b>CEASE FIRING.</b>	<b>STOP SHOOTING.</b>
<b>CLEAR ALL GUNS.</b>	<b>SHOW YOUR BB GUN IS EMPTY. LAY IT DOWN.</b>



# SUGGESTED BB GUN SAFETY RULES

- 1. Always keep the gun pointed in a safe direction.**
- 2. Always keep your finger off the trigger until you are ready to shoot.**
- 3. Always keep the gun unloaded until ready to use.**
- 4. Know how to use a gun safely.**
- 5. Be sure the gun is safe to operate.**
- 6. Use only the correct ammunition for the gun.**



# BB GUN SHOOTING POSITIONS



PRONE POSITION



SITTING POSITION

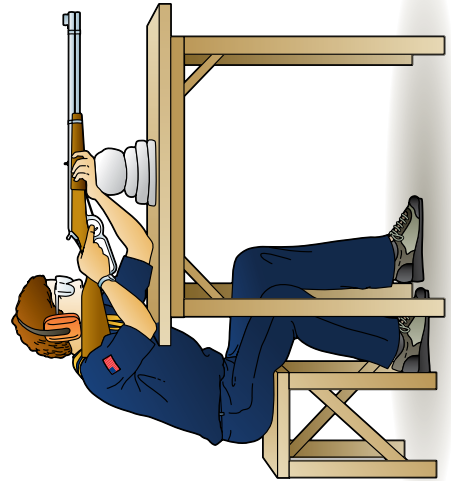

BENCHREST POSITION

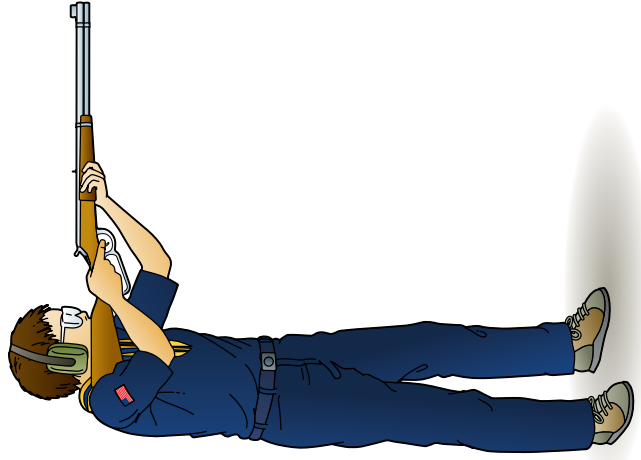

FREE-ARM STANDING POSITION



# TIGER TARGET

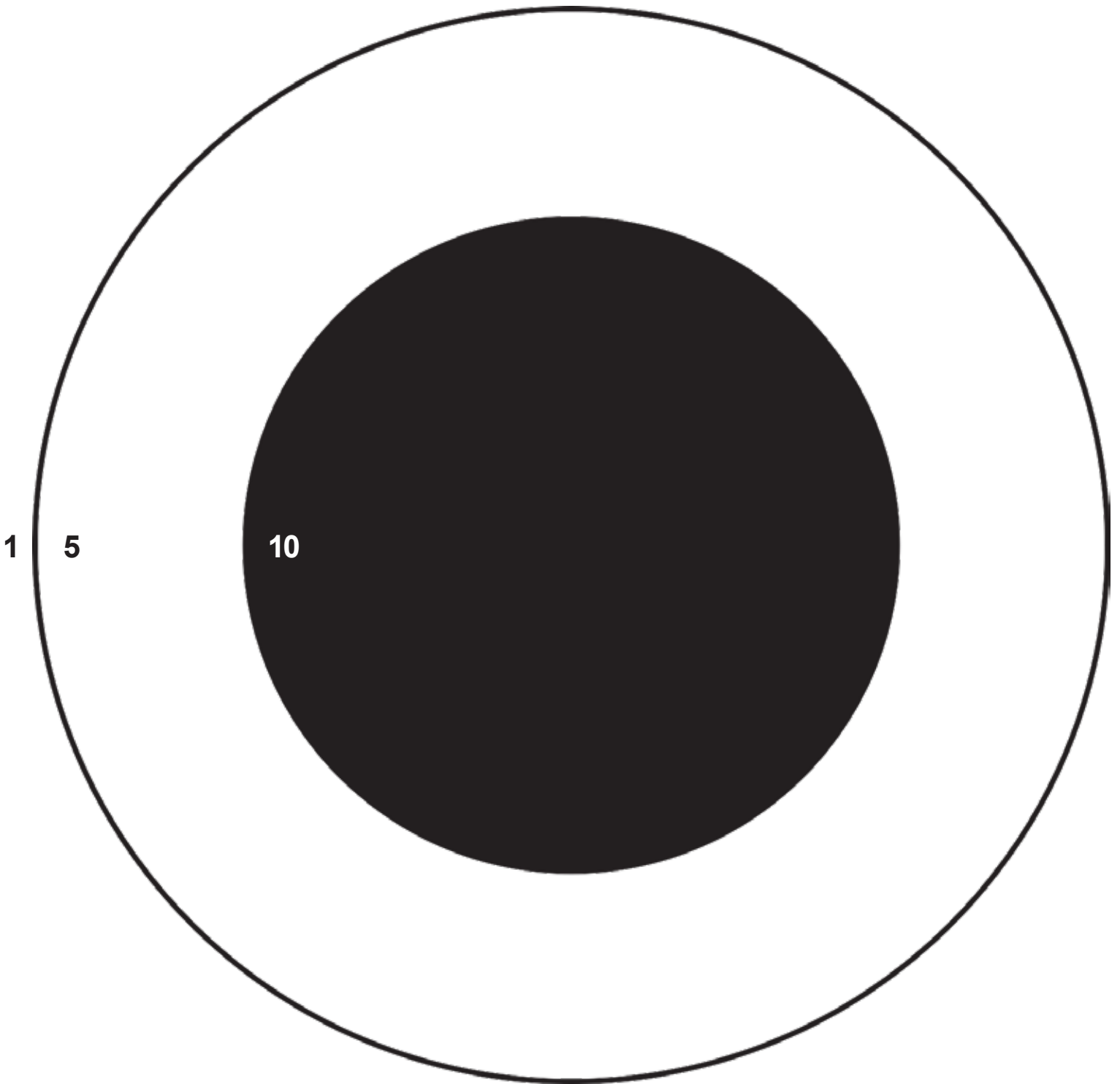

\_\_\_\_\_ Name

\_\_\_\_/\_\_\_\_/\_\_\_\_ Date

\_\_\_\_\_ Score

# WOLF/BEAR TARGET

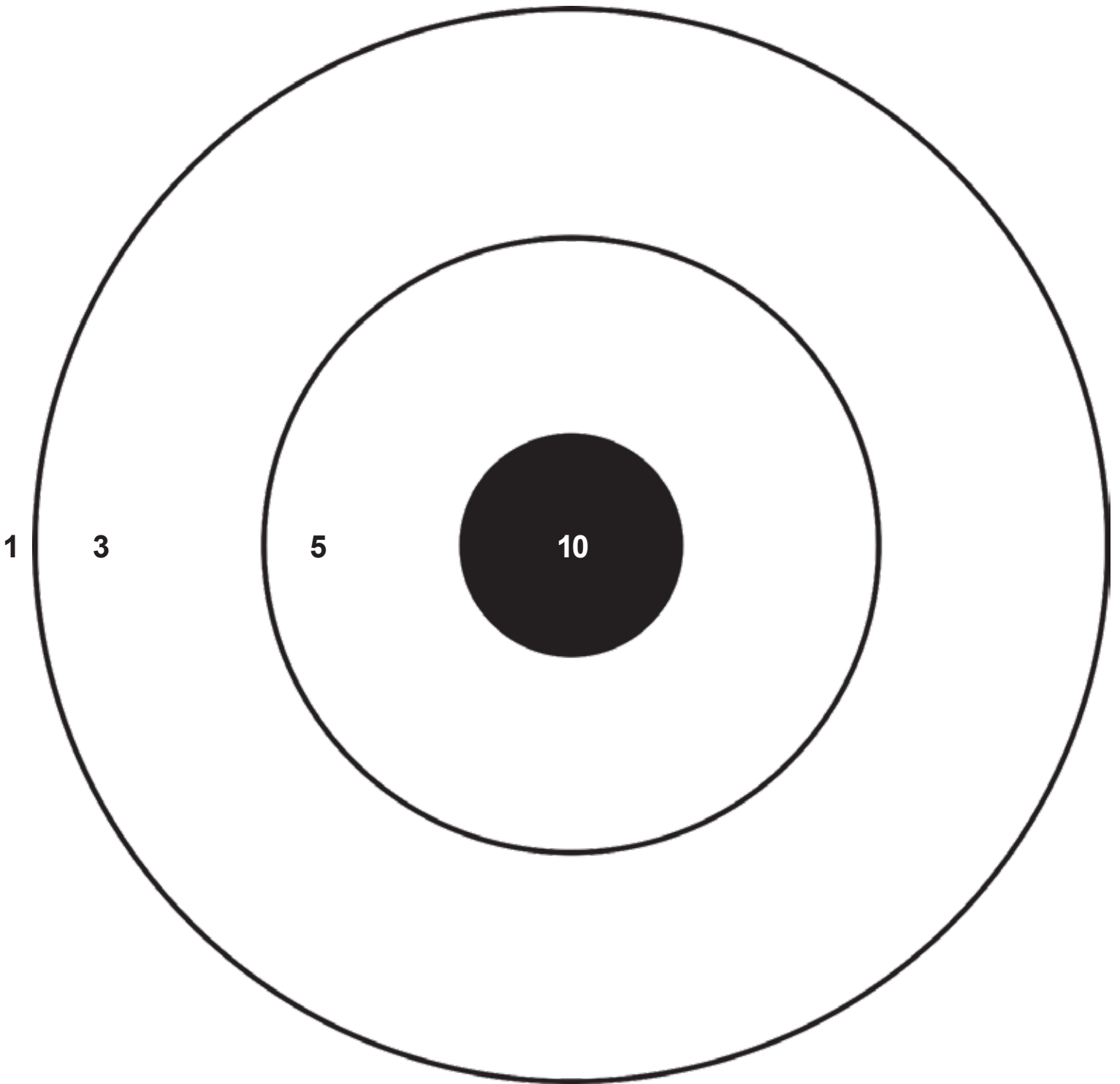

\_\_\_\_\_ Name

\_\_\_\_/\_\_\_\_/\_\_\_\_ Date

\_\_\_\_\_ Score

# WEBELOS/AOL TARGET

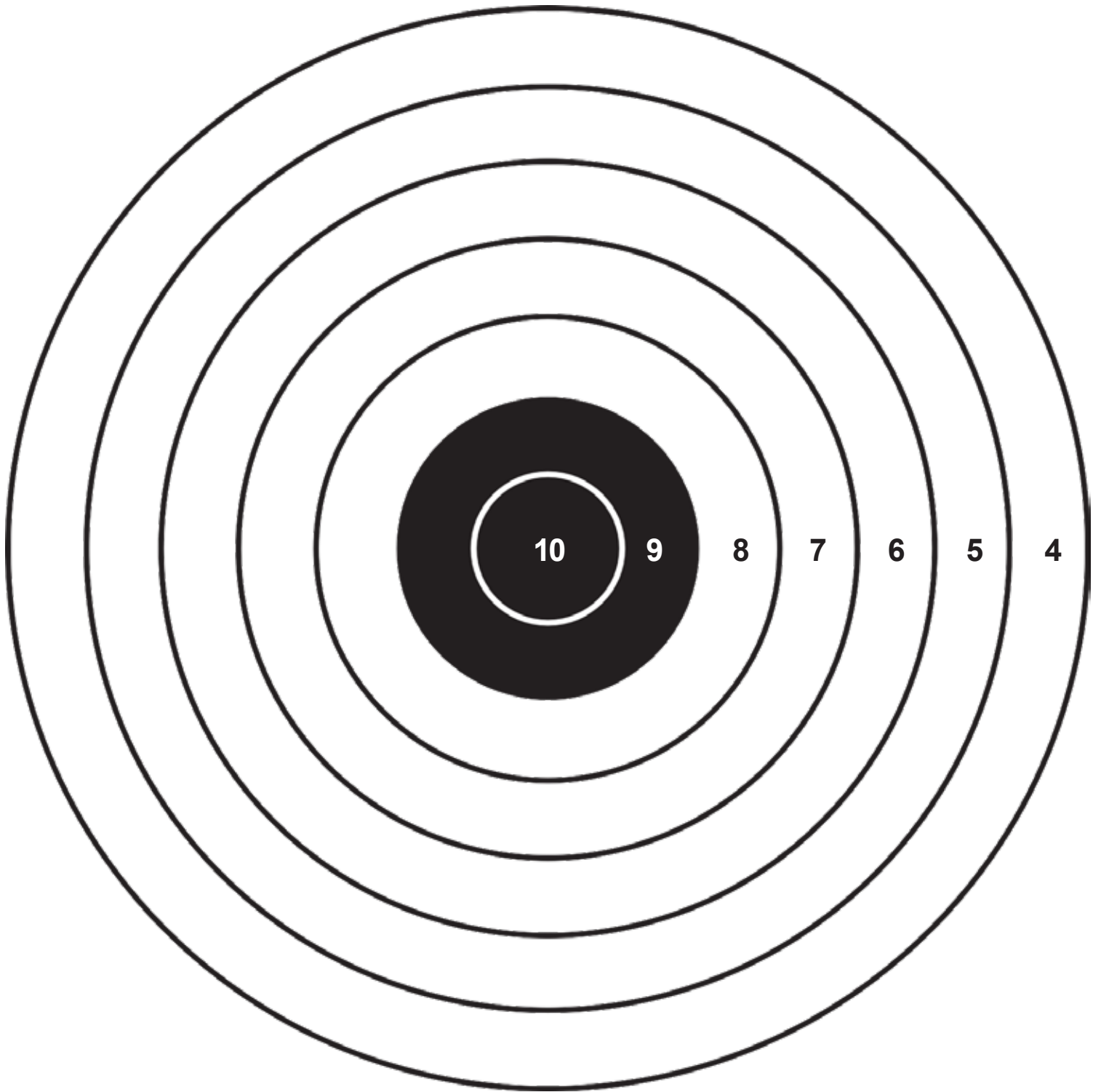

\_\_\_\_\_ Name

\_\_\_\_/\_\_\_\_/\_\_\_\_ Date

\_\_\_\_\_ Score

# ARCHERY RANGE RULES AND COMMANDS

## ARCHERY RANGE RULES

1. Always walk on the range.
2. Keep your arrows in your quiver until you are told to shoot.
3. Only release the bow string when an arrow is nocked and safely pointed toward the target.
4. Leave dropped arrows on the ground until instructed to retrieve them.

**If there is an emergency on the range, immediately tell the instructor.**

## KNOW THE PROPER WHISTLE CODES

**TWO BLASTS = Move up to the line.**

**ONE BLAST = Fire the proper number of arrows.**

**THREE BLASTS = Cease firing. Move to the target. Retrieve and score arrows.**

**FIVE OR MORE WHISTLE BLASTS = Cease firing. Stay where you are. This is an EMERGENCY. Officials will tell the archers what action to take either verbally or by the whistle code.**

**Remember there is only ONE command to shoot — ONE blast of the whistle.**

**For any command of more than one blast, STOP shooting. Watch and listen for further instructions.**



# ARCHERY SHOOTING FORM

(Right-handed archer. Reverse instructions for left-handed archer.)

## Square Stance

- Turn sideways to the target, with left shoulder toward the target.
- Distribute weight evenly on both feet, which are shoulder-width apart.

## Nock the Arrow

- Lay the shaft of the arrow on the arrow rest, and nock the arrow by fitting the notched end of the arrow just below the string's nocking point.
- Face the odd-colored feather (cock) away from the bow.
- Grasp the arrow by the nock between the thumb and index finger of the right hand.

## Draw

- Bring the left hand up, turning the hand so the bow assumes a vertical position at arm's length.
- With the three fingers of the right hand serving as hooks, start the draw slowly.
- The index finger will be above the arrow and the middle two fingers below it.
- At full draw, the right elbow is back and in direct line with the tip of the arrow.

## Anchor

- At the completion of the draw, the relaxed thumb of the right hand finds an anchor spot under the jawbone.
- Using the jawbone as an anchor, the bowstring will touch the nose and the center of the chin.
- It is important that the anchor point be the same for every shot.

## Release or Loose

- The hand is opened with the fingers moving quickly and precisely off the nock and the string at the same time.
- Keep the left arm in the same position as for a full draw.
- Relax wrist.
- Keep alignment.
- Avoid tension.
- Keep the bow at the same level that it was at full draw.

## Follow-Through

- Keep aiming until the arrow hits the target.
- After release, the fingers should not be more than an inch away from and behind the anchor point.
- Hold the position until the arrow strikes the target to make certain the whole process is smooth.
- In a good follow-through, your right hand will be at the back of your neck and your arm will be lined up perfectly.

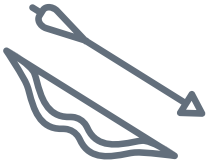

# TYPES OF ARCHERY BOWS

**RECURVE BOW**

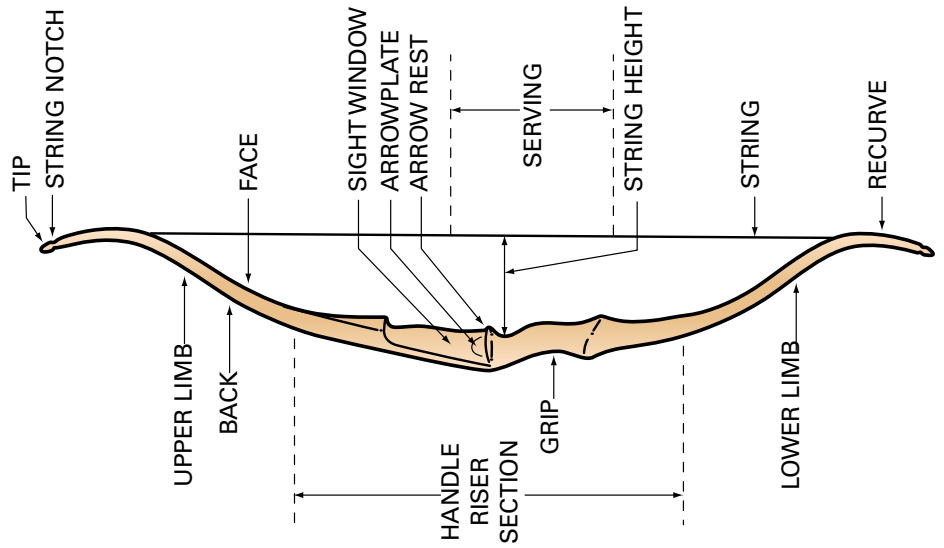

**COMPOUND BOW**

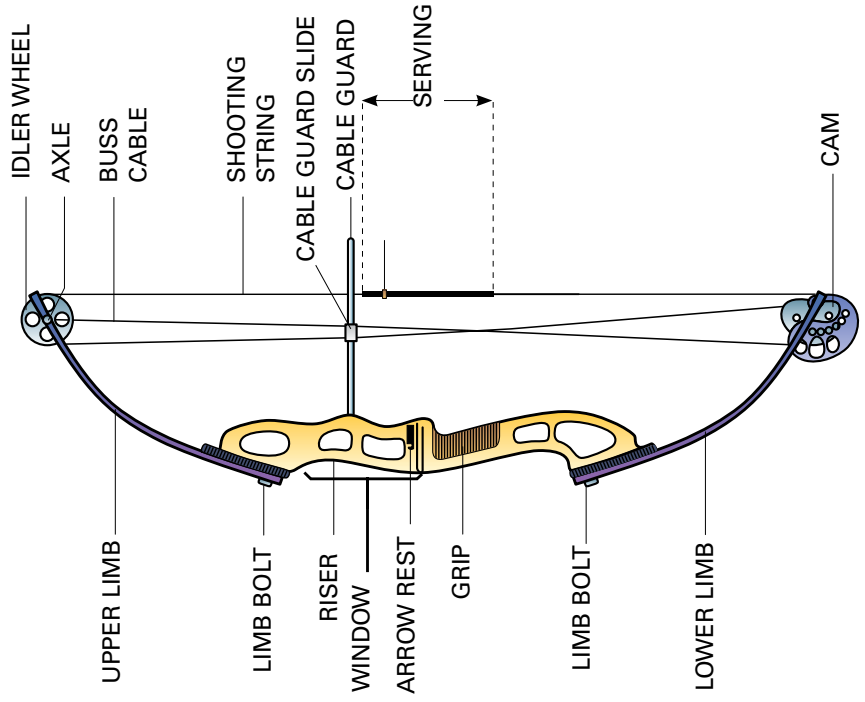



# GENERAL SLINGSHOT RANGE COMMANDS

**LOAD.**

**READY ON THE FIRING LINE.**

**COMMENCE FIRING.**

**CEASE FIRING.**

**LOAD YOUR SLINGSHOT.**

**ALL SHOOTERS ARE READY.**

**YOU MAY FIRE YOUR SLINGSHOT.**

**STOP SHOOTING.**





# GENERAL SLINGSHOT RANGE RULES

1. This range may be opened only by a certified Cub Scout shooting sports range master.
2. All commands issued by the range master must be obeyed immediately.
3. Stay behind the firing line. Do not straddle the firing line.
4. Do not pick up a slingshot unless told to by the range master.
5. Absolutely no running on the range.
6. No horseplay or unnecessary talking on the range.
7. If in doubt about the rules, ask your leader or range master for advice or help.



# SLINGSHOT SAFETY RULES

**ALWAYS KEEP THE SLINGSHOT POINTED IN A SAFE DIRECTION. YOUR RANGE MASTER WILL TELL YOU WHAT DIRECTION IS SAFE. IF YOU ARE NOT SURE, ASK.**

**ALWAYS KEEP THE BANDS AT REST UNTIL YOU ARE READY TO SHOOT.**

**ALWAYS KEEP THE POUCH AMMUNITION FREE UNTIL READY TO USE.**

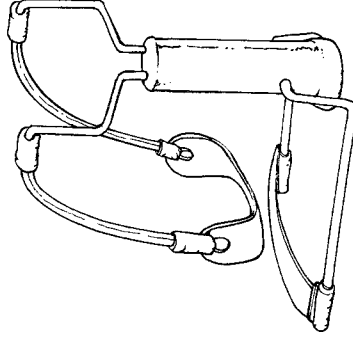



# PARTS OF A SLINGSHOT

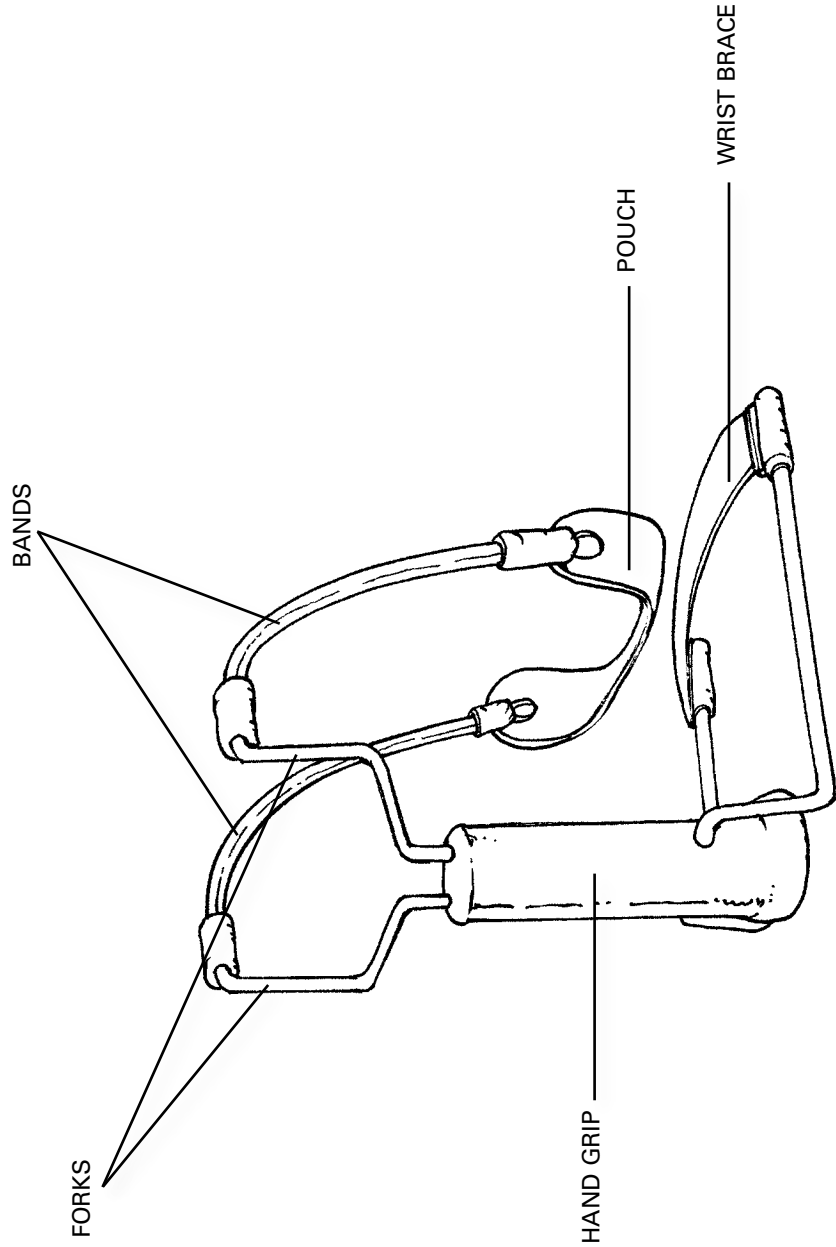

To Pack Advancement Team:

This is to inform you that **Cub Scout** \_\_\_\_\_

has completed the requirements for the Cub Scout Shooting Sports Award as noted below. Please award the patches and devices at your next opportunity.

Rangemaster, please initial the appropriate box(es) below indicating completion of the award.

	<b>BB GUN</b>	<b>ARCHERY</b>	<b>SLINGSHOT</b>
<b>LION</b>			
<b>TIGER</b>			
<b>WOLF</b>			
<b>BEAR</b>			
<b>WEBELOS/AOL</b>			

If all the requirements were not finished, please indicate below which ones were completed with your initials.

**BB GUN**

Level 1—1	
Level 1—2	
Level 1—3	
Level 1—4	
Level 2—S1	
Level 2—S2	
Level 2—S3	
Level 2—S4	

**ARCHERY**

Level 1—1	
Level 1—2	
Level 1—3	
Level 1—4	
Level 1—5	
Level 2—S1	
Level 2—S2	
Level 2—S3	
Level 2—S4	

**SLINGSHOT**

Level 1—1	
Level 1—2	
Level 1—3	
Level 1—4	
Level 2—S1	
Level 2—S2	
Level 2—S3	



## APPENDIX 2: ADDITIONAL ACTIVITIES

### Shooting Sports Program Ideas

Shooting sports activities in Cub Scouting are operated by local councils and districts. The suggestions here are designed for use at council- and district-sponsored events that provide shooting sports opportunities.

The activities described below can be used with slingshots, archery equipment, and BB guns. An important practice across all of Scouting is that we do not use targets that feature human beings or animals.

Targets for BBs, arrows, and slingshots can be made from a variety of materials, including paper, cans, plastic bottles, and balloons. Paper targets can be home-made or purchased. Cans are excellent as they make a great sound when hit. Cans, plastic bottles, and balloons can be hung from strings or attached to netting.

The distance between the shooter and the target can be varied depending on the shooter's level of experience. The distance can be increased as skills improve.

### Fun Target Activities for BB Shooting

#### Target Squares

Make 8.5-by-11-inch targets with several squares on each. Put a number in each square. Shooters can see the squares but not the numbers in them. After firing at the page, the shooter adds up the numbers from the squares that his or her BBs hit. The highest score is the winner.

#### Mystery Dots

Place dots on a target, then shoot at the back side of the target. Count the score from the dotted side.

#### BB Tic-Tac-Toe

Place three rows of three balloons on a target mat. Divide the group into two lines and have them stand in a single file 20 feet from the target. At the signal to shoot, each shooter will shoot one BB and step back. The second and each succeeding person will shoot one at a time. The first team to break three balloons in any line is the winning team.

#### Cracker Shoot

Set up crackers as targets. Have participants shoot at the narrow edges of the crackers.

#### Action BB Gun Shooting Course

Set up an action BB gun shooting course using several games or targets as different stations in the course. Each station could encourage the shooters to use a different shooting position. One station could be used to do maintenance work for the BB gun shooting program.

### Fun Target Ideas for Archery Shooting

#### Archery Tic-Tac-Toe

Place three rows of three balloons on a target mat. Divide the group into two lines and have them stand in a single file 20 feet from the target. At the signal to shoot, each archer will shoot one arrow and step back. The second and each succeeding person will shoot one at a time. The first team to break three balloons in any line is the winning team.

#### Wand Shooting

Place a strip of 1-inch masking tape over the target face from top to bottom. A point is scored when an arrow hits the tape anywhere on the target. Divide the group into two lines, and have them stand in a single file 20 feet from the target. At the signal to shoot, each archer will shoot one arrow and step back. The second and each succeeding person will shoot one at a time. The first team to get two points is the winning team.

#### Shoot the Monster

Participants shoot at a monster face attached or painted on a one-gallon plastic bottle, suspended with shock card within a tire. The object is to hit the plastic bottle. This event can be scored individually or by den or pack.

#### Spin the Insect

A picture of an insect is glued to a piece of plywood 12 inches square. The plywood is fastened so it will pivot freely around a centered bar set from post to post when struck with an arrow.

#### Ring the Bell

Participants shoot at bells through the open end of swinging tires. All tires are swung in unison with a rope tied to the bottom of each tire and extended to an area beyond the limits of firing on the side.

#### Football Placekick

A scaled-down goalpost is erected behind a 4-foot-high canvas sheet. From the firing line the archer can see only the top portion of the goalpost uprights. An arrow shot between the uprights above the crossbar scores as a field goal (three points), while an arrow that passes over the canvas and under the crossbar scores as a touchdown (six points). A raised platform should be set up adjacent to the shooting positions so an observer can determine the scoring, since the archer is not able to see the lower portion of the goalposts.

#### Archery Practice Fun

Any station set up for youth to practice skills is a fun station for the Cub Scouts. The program allows limited times to shoot arrows, so the opportunity to practice at a council camp or event is a great experience for them. A practice station is a simple, basic archery range, but a very fun one for the Scouts.

Archery stations could also be set up to practice stringing bows or to learn how to care for some of the equipment. Helping with some of the archery equipment could be a rainy day activity.

### **Action Archery Course**

An action archery course could be set up using several of these games as different stations in the course. A drawing of a sample action archery course is available in the *BSA National Shooting Sports Manual*.

### **Fun Target Ideas for Slingshot Shooting**

#### **Feed the Monster**

Using a large piece of cardboard, sketch a monster. Cut a hole where the monster's mouth is located. Aim to feed the monster.

#### **Tin Can Alley**

Hang tin cans from string. Place them at various heights and distances from the shooting line.

#### **Tire Target**

Hang tires (or hoops) at different heights and distances from the shooting line.

#### **Ring-a-Ding**

Hang bells from strings. Shoot to strike the bells.

#### **Chart Paper Target**

Create a large target with chart paper. Draw circles of different sizes on the chart paper. Apply different scores to the circles, with large circles being worth fewer points.

#### **Slingshot Target Course**

A target course could be set up using several of these games as different stations in the course. A drawing of a sample action archery course is available in the *BSA National Shooting Sports Manual* and can be adapted for a slingshot target course.

### **Bikathlon**

The bikathlon event is modeled after the winter Olympic biathlon in which competitors cross-country ski and shoot rifles. In the bikathlon, the Cub Scouts bike around an off-road course, stop at various points, dismount from the bikes to shoot targets that fall over when struck, and then continue along the course. Though the sport requires a certain amount of strength for the biking portion, the shooting sports activity is the key to the event.

#### **Setting Up the Course**

Make the course approximately one-third of a mile in length, in the form of a loop so the starting line and a finishing line are in the same position. One point along the course becomes the firing line—with a separate

position for each racer. Identify each firing point with a color, as assigned to each participant. Place a bike rack in a safe place with easy access. The course should not be in a rocky area, and the instructors should walk it to ensure that all dangerous obstacles have been removed. The course can be an existing track or laid out with cones or rope guides to make sure each biker follows the same route.

#### **Running the Race**

The bicycle is ridden to the shooting point, the youth dismounts, parks the bike, and shoots the targets. The biker shoots at each target until it is hit and knocked over, then remounts the bike and finishes the race. A limit may be imposed on the number of shots for each target and a time penalty imposed if the target is not knocked over.

The youth finishing the race in the shortest time is declared the winner. The key to the event is not only to pedal fast, but also to shoot quickly and accurately.

Shooting is normally done from the standing position but may be changed at the range director's discretion.

Participants are never allowed to ride the course with the gun, arrows, or slingshots. These items are to remain at the firing point at all times.

Every participant is required to attend a brief orientation on bike safety and handling the shooting sports materials used on the course before being allowed to participate in the bikathlon.

This safety session should, as a minimum, cover the following:

- Course layout and general rules
- Range procedure and safety
- How the match is scored
- How to operate and load the guns
- Shooting safety and safe gun handling
- Basics of sighting and shooting
- Bicycle use and riding safety
- Hands-on practice as time, personnel, equipment, and facilities allow

## Archery Range Rules and Commands

### EQUIPMENT AND MATERIALS

- Bikes
- Elbow and knee guards
- Safety helmets
- Stopwatch or other timing device
- Cub Scout Shooting Sports Award certificates
- BB approach:  
BB guns and BBs at each shooting station  
Safety glasses to be worn at the firing line
- Archery approach:  
Bow and quiver of arrows at each shooting station
- Slingshot approach:  
Slingshot and ammunition at each shooting station
- Alternative:  
Use all of the above at different stations.

### PERSONNEL

Assign adults to the following positions:

- Match director (responsible for the event)
- Jury (three people who are responsible for solving any dispute that may arise during the match and to ensure compliance of the rules by participants)
- Rangemasters (responsible for safety on the range)
- Statistical officer (responsible for tracking participants' total lapse time)
- Starter (the official who starts each relay or heat)
- Other personnel needed are timers, first-aid personnel, course marshals, and repair personnel (for guns, arrows, slingshots, and/or bikes)
- One staff member at each station

## ACKNOWLEDGMENTS

The Boy Scouts of America would like to sincerely thank all volunteers and professionals that contributed to this project. The dedication of the Cub Scout Program Development Task Force, USA Archery, and National Rifle Association is greatly appreciated. In addition, a special thank you goes out to the 2015 Philmont Training Center staff and faculty who were invaluable in the pilot of the Cub Scout Shooting Sports Award requirements.

### Photo and Illustration Credits

All photos and illustrations are the property of or are protected by the Boy Scouts of America.



# APPENDIX 21 - RESOURCES

## People

- Who to call for help
  - Contact your local council's shooting sports committee chair
  - Boy Scouts of America:  
[shooting.sports@scouting.org](mailto:shooting.sports@scouting.org)
- Local council websites
- The National Rifle Association
- Contact USA Archery, [www.usarchery.org](http://www.usarchery.org)
- Contacts at the National Shooting Sports Foundation

## Facilities

- Scouts BSA local council camps
- Local shooting sports clubs
  - National Wild Turkey Foundation, [www.nwtf.org](http://www.nwtf.org)
  - Issac Walton League, [www.iwla.org](http://www.iwla.org)
- Local shooting sports ranges
  - State wildlife ranges. Contact your local department of natural resources.
  - Law enforcement ranges
  - National Forest Service ranges
- Local gun and archery businesses
  - May have local range information as to where you can shoot

## Materials/Literature

- National Rifle Association, [www.nra.org](http://www.nra.org)
- National Archery in the Schools Program, [www.naspschools.org](http://www.naspschools.org)
- National Sporting Clays Association, [www.mynsca.com](http://www.mynsca.com)
- National Skeet Shooters Association, [www.mynssa.com](http://www.mynssa.com)
- International Hunter Education Association, [www.ihea-usa.org](http://www.ihea-usa.org)
- National Muzzle Loading Rifle Association, [www.nmlra.org](http://www.nmlra.org)

## Equipment

- National Shooting Sports Foundation, [www.nssf.org](http://www.nssf.org)
- Archery Trade Association, [www.archerytrade.org](http://www.archerytrade.org)
- Daisy, [www.daisy.com](http://www.daisy.com)
- Crosman, [www.crosman.com](http://www.crosman.com)
- Benelli, [www.benelliusa.com](http://www.benelliusa.com)
- Beretta USA, [www.berettausa.com](http://www.berettausa.com)
- Browning, [www.browning.com](http://www.browning.com)
- Remington, [www.remington.com](http://www.remington.com)
- Winchester, [www.winchester.com](http://www.winchester.com)
- Federal Premium Ammunition, [www.federalpremium.com](http://www.federalpremium.com)

## Programs

### *Advancement and recognitions*

- Scouts BSA
  - Merit badges. Refer to Chapter 3, “Merit Badge Counselors,” rifle shooting, shotgun shooting, archery.
- Cub Scout
  - Cub Scout Shooting Sports Award Program Refer to Chapter 2, BSA Shooting Sports — “A Wealth of Year-Round Opportunities.”
- Venturing
  - Ranger Award
  - BSA Shooting Sports Outstanding Achievement Award. Refer to <https://www.scouting.org/awards/awards-central/venturing-shooting/>
- Sea Scouts
  - Sea Scout Marksmanship Program. Refer to [www.seascout.org](http://www.seascout.org)

### *Events*

- Unit
  - Cub Scouts may participate in shooting events only at council- and/or district-level activities. Scouts BSA troop, Venturing crew, and Sea Scout ship activities are based on qualifications of personnel and adequacy of ranges that meet or exceed BSA requirements spelled out in this manual and the *Guide to Safe Scouting*.
- District
  - Cub Scout day camp programs
- Council
  - Summer camp programs
  - Cub Scout resident camp programs
  - NRA postal matches. Refer to Chapter 2 and <http://compete.nra.org/nra-postal-matches.aspx>
  - NRA Day. NRA Day is a great way to introduce youth to shooting sports and shows what the NRA has to offer. The event can be tailored to meet the needs of the group with many themes to choose from.

# Prepared. For Life.®



Boy Scouts of America  
1325 W. Walnut Hill Ln  
P.O. Box 152079  
Irving, TX 75015-2079  
[www.scouting.org](http://www.scouting.org)

430-938  
ISBN 978-0-8395-0004-9  
©2022 Boy Scouts of America  
2022 Printing