

# Narcoossee District



## Webelos Woods 2025

### Participant Guide

January 17<sup>th</sup>-19<sup>th</sup> 2025  
Camp LaNoChe

Host: Narcoossee District  
Unit Support: C911, T23, T4184, T184  
Webelos Woods Chief: Evan Yaros

## **About Webelos Woods**

Webelos Woods was founded in 2004 by Crew 911 Adult Advisor Don "Red" Collier in the old Fort Gatlin District. Traditionally the event has been held in the month of January every year. It is staffed by the members from Crew 911 as well as other volunteers from local Scouts BSA Troops and Venture Crews in Narcoosse District. One of the major events of Webelos Woods is the flag retirement ceremony, conducted by Crew 911 on Saturday evening. In this ceremony the members of Crew 911 demonstrate the proper and respectful methods for retiring the American flag.

## **General Camp Information**

- A. Webelos Units may start checking in at the registration tent and start setting up their campsites no earlier than 4pm Friday afternoon.
- B. Webelos Units will have their campsites inspected in the same manner as the Scouts BSA Units' campsites.
- C. Each Webelos Unit who have Patrol Flags displayed during inspection earn extra points for Scout Spirit.
- D. Awards given out will consist of Attendance, Camp Inspections, patrol flags and desserts.
- E. The Spirit Log will be awarded to the Webelos Unit with the most Scouting Spirit on Sunday morning.
- F. The entire Webelos Wood schedule is subject to change and/or modification based on inclement weather. Scout safety is our priority.
- G. All Scouts are expected to adhere to the scout oath and law. Remember you are representing your Pack. Friendly competitiveness is the goal.

## **Recognition/Awards:**

Awards will be given out during the Closing Ceremony on Sunday morning.

- Ribbons for 1st, 2nd, and 3rd places to individuals in most events for youth.
- Ribbons for Lash Box Derby for 1st, 2nd, and 3rd place youth teams.
- Ribbons for the Best Campsite, Pack with Largest Scout Attendance, Best Patrol Flag, and Best Dessert for 1st, 2nd, and 3rd place Packs for each title, respectively.
- The Webelos Woods Spirit Log will be awarded to the pack with the most Spirit, as judged by the WW staff.

## General Campsite Rules and Procedures:

### All rules are to be followed in coherence with the *Guide to Safe Scouting*

**Fires:** All fires must be in a fire ring established by the camp. You must bring your own wood to burn. The fire will always be attended when burning by a Scout or adult chaperone. The fire will be completely put out before leaving the campsite or going to bed.

**Smoking:** Smoking is not permitted at any Scouting Event except designated areas. The closest designated area will be located behind the LaNoChe Trading Post. We ask adults to set a good example and not smoke in any other locations.

**Garbage and Litter:** All garbage must be removed from your campsites before you leave on Sunday. Leave No Trace is one of the vital lessons that is learned while in Scouts BSA. A good rule of thumb: leave the area in *better* condition than when you arrived.

**Vehicles in Camp:** One vehicle and one trailer per Webelos Unit are allowed in the camping area. All other vehicles will need to park in the designated parking area on the main road of Camp LaNoChe. Via the Camp Safety Director, parking decals will be given out to the Cubmaster allowing one vehicle and trailer per pack.

**Water/Cleaning Station:** There are a few water spigots located throughout the camping area. This water can be used for filling up water bottles. We ask that you turn the water off when you are finished using the spigots. Do not use water spigots for cleaning your pots, pans, or any other kind of cooking equipment! Each Webelos Unit is responsible to have a cleaning station/dishwashing station set up in camp for this purpose. This is one of the required campsite elements expected to be seen during inspection.

**Restrooms:** Camp LaNoChe has bath house at each designated campsite. The bath houses have hot water for showers and unisex single-stall toilets. Note: Sinks, showers, and spigots at the restrooms are not to be used for cleaning pots, pans, or any other kind of cooking equipment.

**First Aid:** Camp LaNoChe has a building dedicated to First Aid located in the central corridor area of camp (near the camp office and dining halls), but **all** incidents need to be communicated to the Webelos Woods Chief for proper documentation at HQ before proceeding to the Health Lodge building. \*The health lodge might not be staffed during our event so please have your first aid kit properly filled. \*

**Riding a Bike:** BSA Policy states that you must wear a helmet while riding a bike. Anyone not wearing a helmet will be asked to get off the bike and walk it back to their campsite to get a helmet.

## Scout Uniform

Scouts must wear your Field Uniform (“Class A”) for:

- a. Arrival and departure from the campout
- b. Assembly for the Opening and Closing Ceremonies
- c. Non-denominational Service

All other activities require a Pack Activity Shirt (“Class B”).

## Campfire Program

Saturday night will consist of a traditional Scouts BSA program featuring skits and songs. Each Webelos Unit can participate in the campfire and must see the Campfire Chief before 4pm on Saturday to confirm participation. Each Webelos Unit participating in the campfire program will earn extra points for Scout Spirit.

Camp fire closing will be a flag retirement ceremony to honor those who have fallen and those that are currently serving our Country.

### **Emergency/Evacuation/Mobilization:**

In the event of a Camp-wide emergency, an alarm will go off that requires all Webelos Woods Units (i.e., the entire Camp) to assemble in their activity shelters. The alarm will sound like a loud siren and will continue to go off until all Scouts and Scouters have checked in with their units and a designated leader has reported the status at the Webelos Woods HQ. All Webelos Units, their leaders, parents, and siblings will assemble at their activity shelter and one leader shall report the units' status to the WW HQ area. The leaders will report to the Camp Chief, with their head count and report either all present or the names of any missing persons.

Severe weather is common during Webelos Woods and will be monitored for any immediate danger for our event. If such weather occurs, staff members will direct you with further instructions.

## Check Out

Notify a staff member at Webelos Woods Headquarters that you are ready to leave, and a staff member will visit and inspect your campsite prior to departure. Webelos Units should be ready to depart at the time of inspection. The campsite should be clean of litter and all garbage (trash cans are located along the road). After your Webelos Unit has passed the final inspection, you will be given your Webelos Woods patches, and you will be allowed to leave.

## Schedule

### Friday

Event	Location	Time
Registration	Webelos Woods Head Quarters (HQ)	4pm – 9pm
Cracker Barrel	Webelos Woods HQ (Campsite 3)	9pm
Quiet time	Your campsite tents	10:30pm

### Saturday

Breakfast	Your campsite	6am
Opening Ceremony	Open field next to Webelos Woods HQ	7:45am
Camp site inspections		9am -12pm
Primary events	Sports Field	8am – 12pm
Lunch	Your campsite	12pm
Lash Box Derby check-in	Sports Field	1:30pm
Lash Box Derby races	Sports Field	1:45pm
Run-offs for all events	Sports Field	TBD
Visit Scouts BSA Troops	Troop campsites	Ask Troops
Dinner	Your campsite	5pm
Dessert Judging	Deliver your dessert to HQ for judging	6pm – 6:30pm
Campfire program	Council Fire Ring (by lakefront)	Approximately 8pm
Quiet time	Your campsite tents	11pm

### Sunday

Breakfast	Your campsite	7am
Non-denominational service	Sports Field	8:45am – 9am
Closing ceremony and Awards Presentation	Sports Field	9am
Checkout	Webelos Woods HQ (Campsite 3)	9:45am

**++Schedule is subject to change at any time during the event++**

++Note that BB and Archery are at the Sport Field. Schedule TBD++

++ Look for schedule posted Saturday morning++

## Campsite Inspection Checklist:

Pack #: \_\_\_\_\_

Campsite: \_\_\_\_\_

<b>Campsite Inspection Scorecard for Webelos Woods</b>	<b>5</b>	<b>10</b>	<b>n/a</b>
Pack flag displayed properly			
American flag displayed properly			
Meal menu posted near cooking area			
Duty roster posted near cooking area			
Garbage in bags / protected from animals			
Campsite free of litter			
Cooking gear clean & properly stored			
Cleaning station/Dishwashing station set up			
Cooking area surfaces are clean and free of litter and personal gear.			
Drinking water is set up in campsite.			
Food securely stored from animals & according to food safety guidelines, i.e., temperature.			
First aid kit is out, clearly marked, and accessible.			
Water bucket at campsite fire ring & filled.			
Shovel left at fire ring.			
Campfire is cold-out if unattended.			
Tents are properly set up in a straight line, doors facing the campsite.			
Webelo Scout-made camp gadgets: 10 points each.			
<b>Total Points:</b>			

+Possible Points: 160, plus possible bonus points for camp gadgets\* (max bonus is 3 gadgets) +

For ideas for Camp Gadgets, see <https://scoutpioneering.com/favorite-projects/>

## Camp Duty Roster

Patrol: \_\_\_\_\_

Date: \_\_\_\_\_

Saturday			
	Breakfast	Lunch	Dinner
Cook			
Assistant Cook			
Clean Up 1			
Clean Up 2			

Sunday	
	Breakfast
Cook	
Assistant Cook	
Clean Up 1	
Clean up 2	

## Patrol Flag Judging Criteria

<b>Patrol Flag Judging Score Sheet</b>	<b>5</b>	<b>10</b>	<b>N/A</b>
Scout-made			
Names of all patrol members			
Patrol name			
Pack number			
Patrol symbol/image			
Craftmanship			
Designed to be easily carried			

\*Each criteria item is worth 10 points for a maximum of 70 points\*

## **Coveted Spirit Log**

The Spirit Log has been a tradition ever since the beginning of Webelos Woods. One Scout spirit filled pack will win this award and will be able to hold on to it for one whole year until they return it upon the following year. Previous Scouts have said this is the best part of the event and the most rewarding.

- Wear your pack's uniform/activity shirts all day Saturday
- Make sure your Patrol yells and cheers when appropriate
- Participate in campfire program
- Participate in crackle barrel
- Be helpful and friendly to other packs during events
- Show good sportsmanship
- Attend opening and closing flag ceremonies
- Make sure to display your Patrol flag, including carrying around as appropriate



## Events

Individual Patrols should stay together in their group and travel together to each event. It is important to participate in each event even if no award is given as this contributes to consideration for the Spirit Log.

Please refer to the included chart for:

- 1/4 Mile relay
- 50-yard Dash
- Pull-Ups
- Distance Jump
- 3-man Tug-o'-War
- Football Distance Toss
- BB gun (no award)
- Archery (no award)
- Fire building
- Flip the Tarp
- Roll up the sleeping bag
- Knot tying
- Hide -n- Tarp Gear Guess
- Tug of war

\*Please note some events may be canceled morning of\*

# Sign up for important updates from Webelos Chief.

Get information for **Webelos Woods 2025** right on your phone—not on handouts.

Pick a way to receive messages for **Webelos Woods 2025**:

**A** If you have a smartphone, get push notifications.

On your iPhone or Android phone, open your web browser and go to the following link:

[rmd.at/narww24](http://rmd.at/narww24)

Follow the instructions to sign up for Remind. You'll be prompted to download the mobile app.

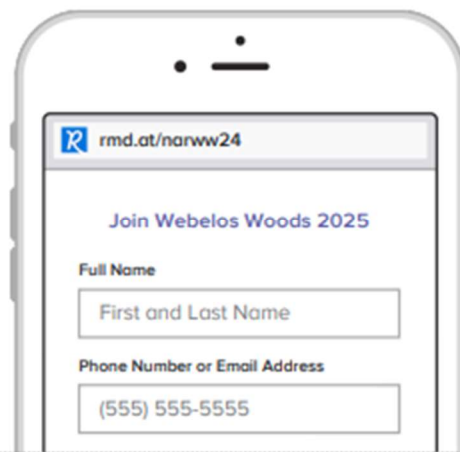

**B** If you don't have a smartphone, get text notifications.

Text the message [@narww24](#) to the number 81010.

If you're having trouble with 81010, try texting [@narww24](#) to (415) 813-2646.

\* Standard text message rates apply.



## Building a Lash Box Derby Car

1. The Base of the car (Center Board) should be either a piece of 2" x 10" x 5" or 2" x 12" x 6". See illustration below.

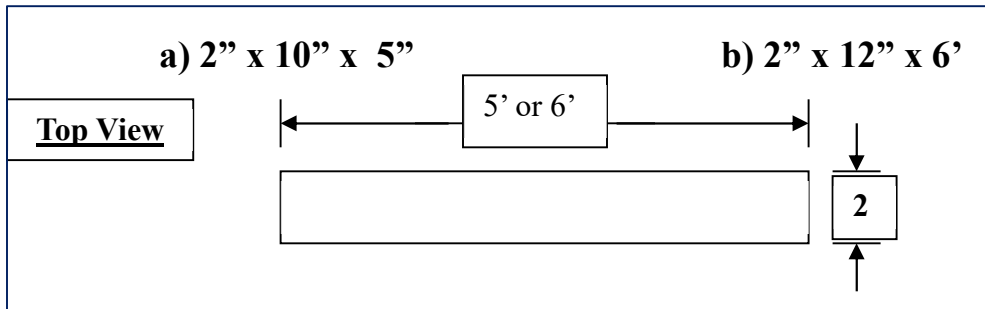

2. Front and rear axles will be made from 2 pieces of 2" x 4" x 36". 36" is the maximum length of both axels. See illustrations below.

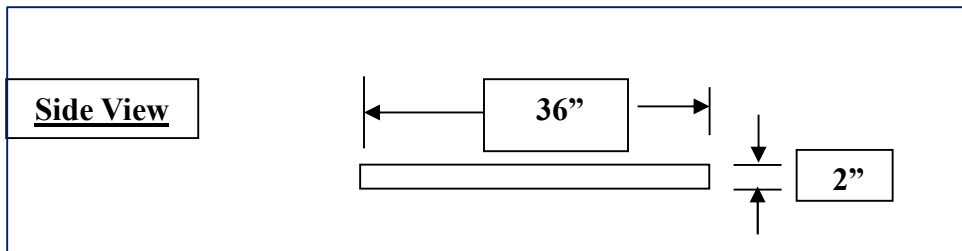

3. First locate where you want the front axle to be position on the Center Board. Then drill hole through both pieces of wood where the front axle will be installed. See illustration below.
4. Use a piece of 1/2" thin wall conduit pipe, cut it to the correct length so that when installed it will pass through the two holes that were drilled and will be flushed on top and bottom of the two pieces of wood. This conduit will be used as a sleeve so it will make the turning of the axel easy. Start by installing the piece of 1/2" conduit through the Center Board, as it starts out the bottom of the Center Board insert a large washer around the conduit, and then start it through the axel. When it is flush with the top of the Center Board and flush with the bottom of the axel, insert a 3/4" x 5" bolt and 3/4" washer from the top of the Center Board through both pieces of the wood. On the bottom of the axel where the 3/4" x 5" bolt comes through install a 3/4" washer, 3/4" locknut and 3/4" nut. See illustration below.

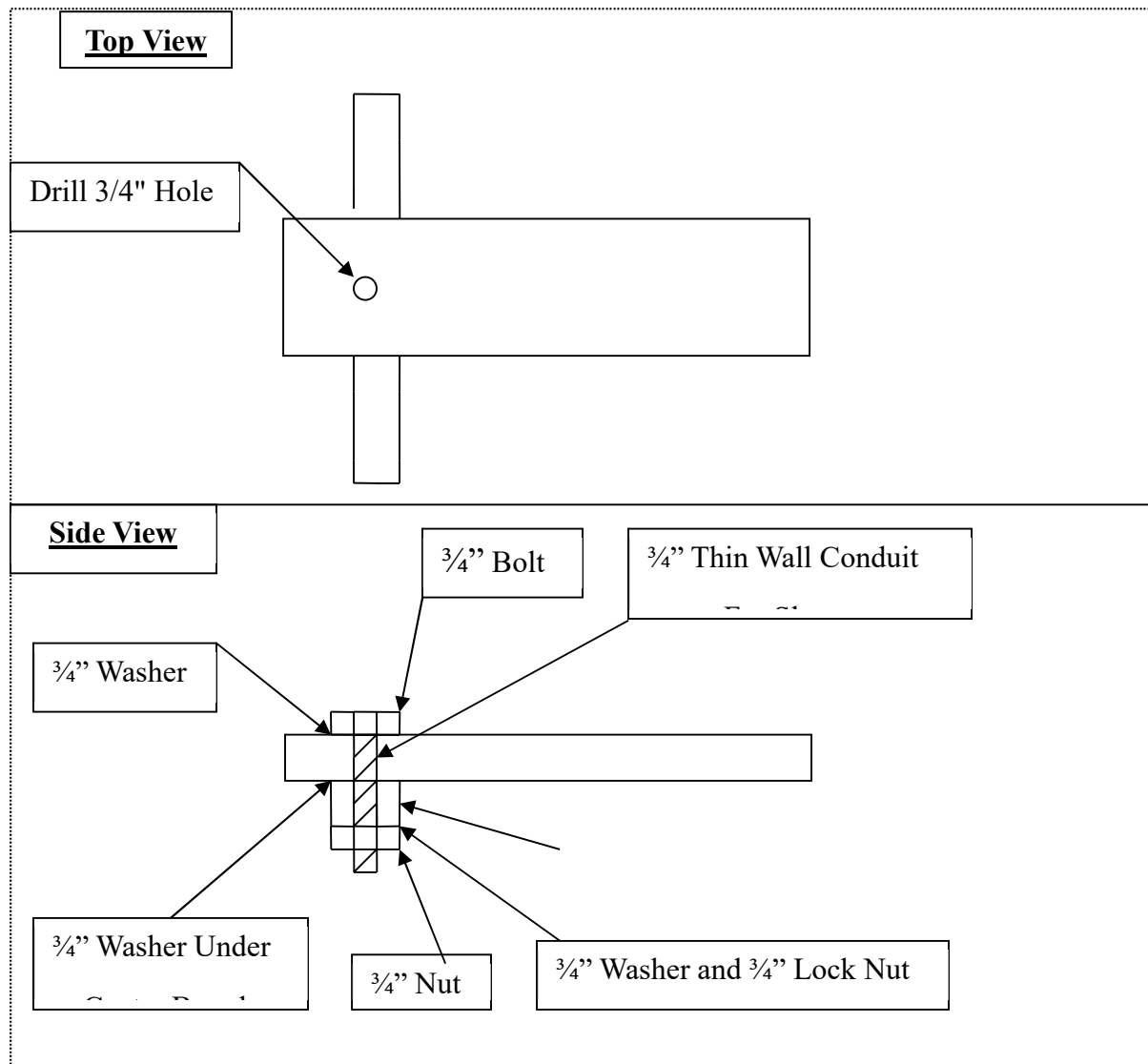

- Next locate the position on the Center Board where the rear axle will be mounted. Mark the location and drill (4) 1/2" holes where it will be attached. Use (4) 1/2" bolts, (4) 1/2" washers, (4) 1/2" lock nuts and (4) 1/2" nuts. See illustration below.

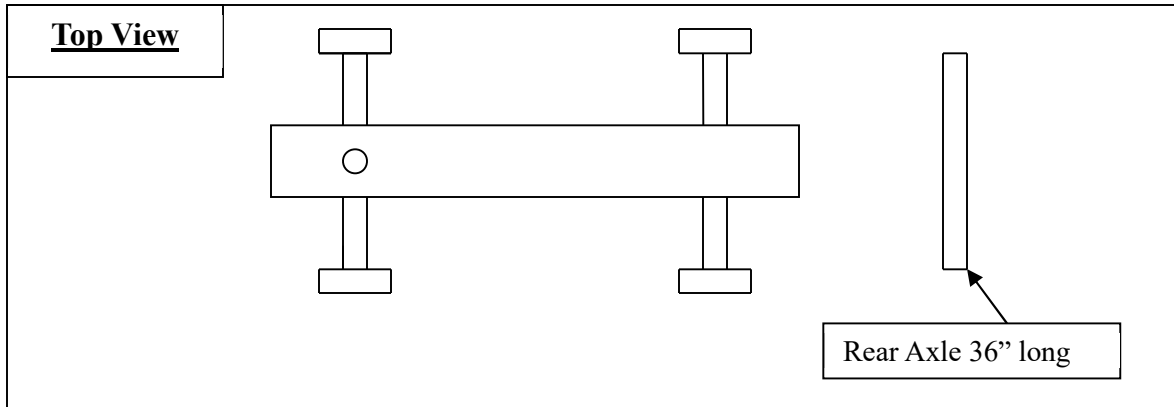

6. Wheels will be your choice. They must be firmly attached and spin freely. See illustration below.

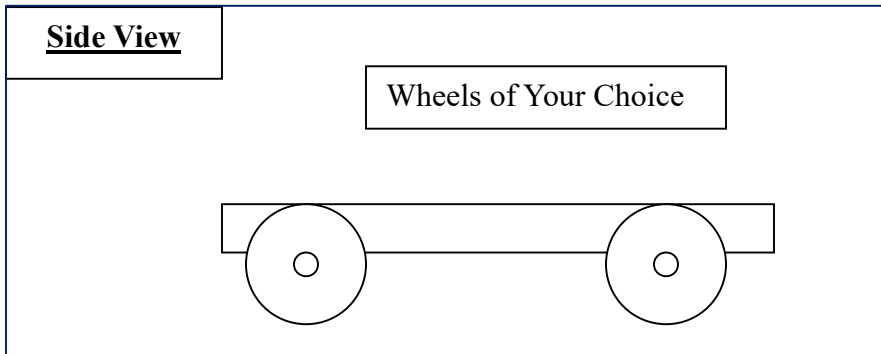

7. Next install the steering. Steering will be composed of some type of rope (**NOT CABLE**), or steering wheel assembly. If using rope, it must be securely to the front axle on both sides. Next install the seat. See illustration below.

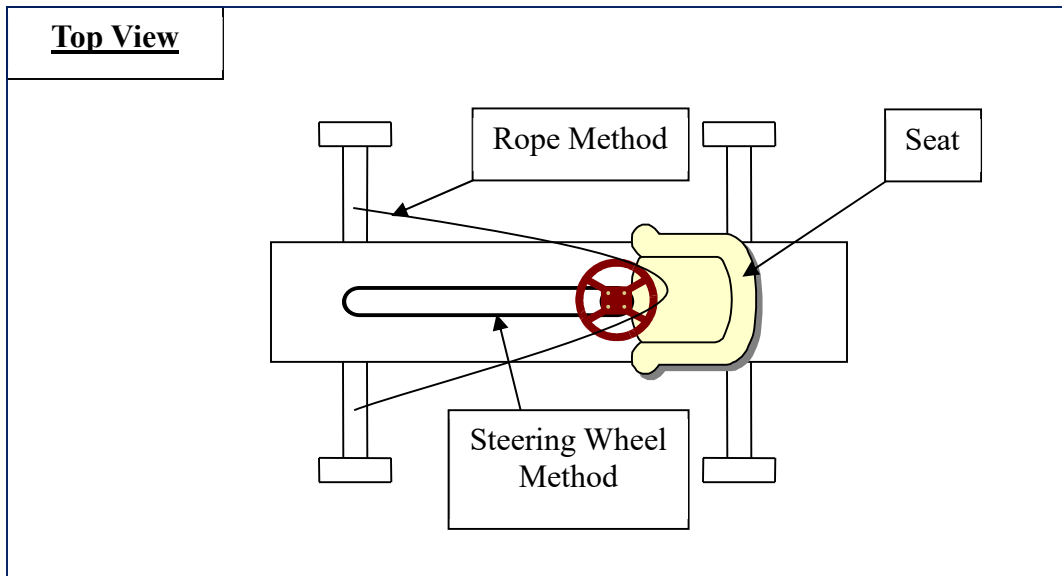

8. Now installed the driver's seat. You **MUST MAKE SOME TYPE OF SEAT BELT** OR THE SCOUTS WILL NOT BE ABLE TO RACE. It must be adjustable so both the Scout and others can use it for the races.

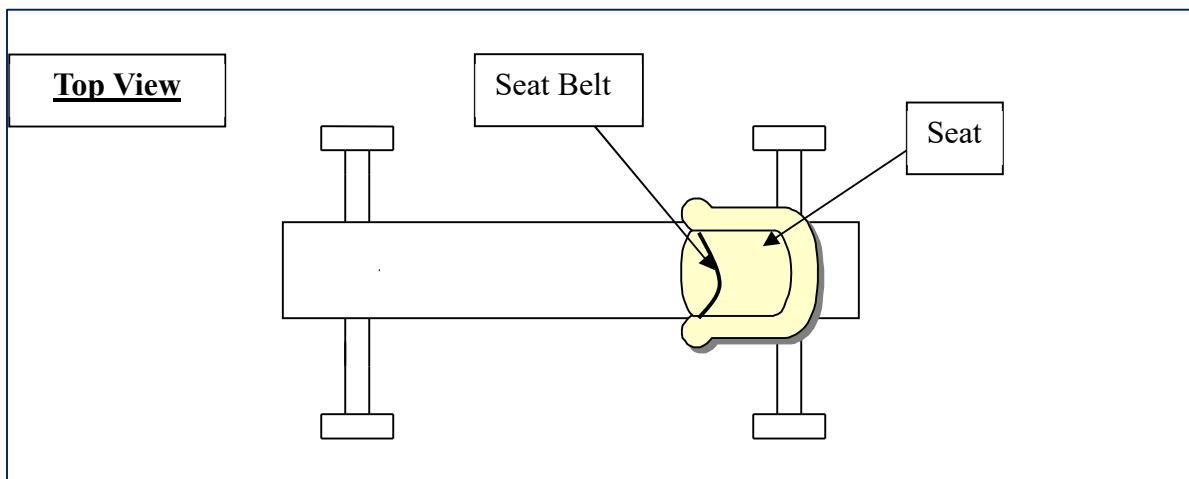

9. Next install some type of a **Hand Brake**. You may use a piece of 1" x 2" x?" depending on how high your car sits off of the ground. You may attach the hand brake to the side of the Center Board, using a 1/2" x 4" lag screw. Next drill a 1/2" hole in the Hand Brake Handle, where it will be attached. The screw will pass through the hole and then attach to the frame. On the bottom of the hand brake attach a piece of an old tire to it so it can contact the ground, or you can make the brake, so it rubs the rear tires when applied. If using a hand brake remember that the handle must be pulled back toward the rear of the car so that the rubber will contact the ground.

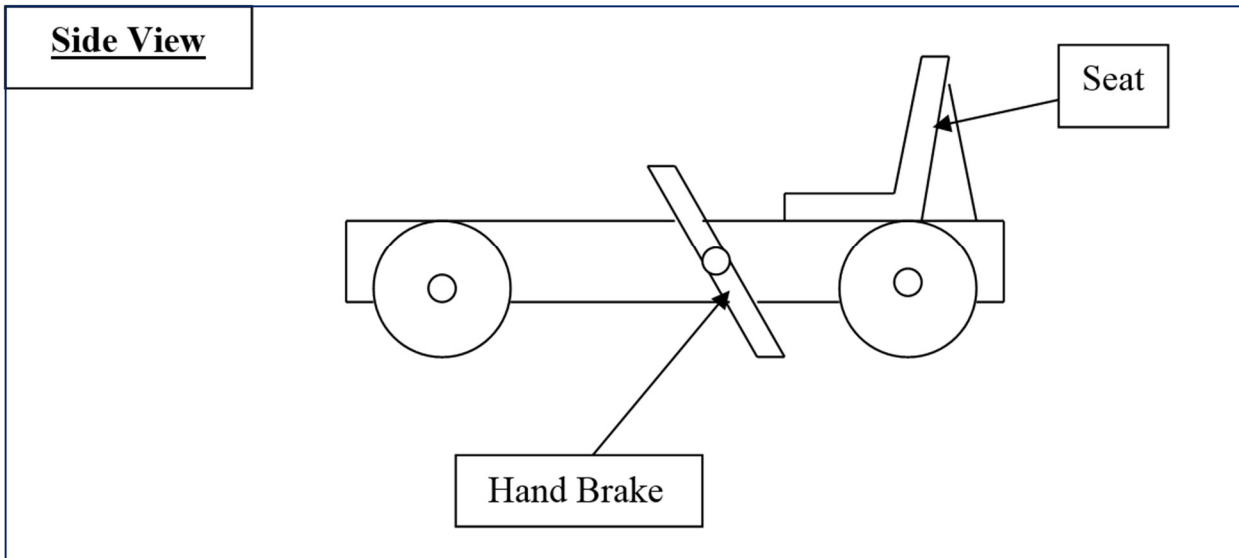

10. The Power requirements for the car are One Driver and 3 Scouts pushing. The three scouts must be pushing the car using the BACK PUSH BAR. See illustration below. When building the push bar, always remember that the push bar handle that the Scouts will have their hands on is NOT TO EXCEED 36" which is the width of the axels.

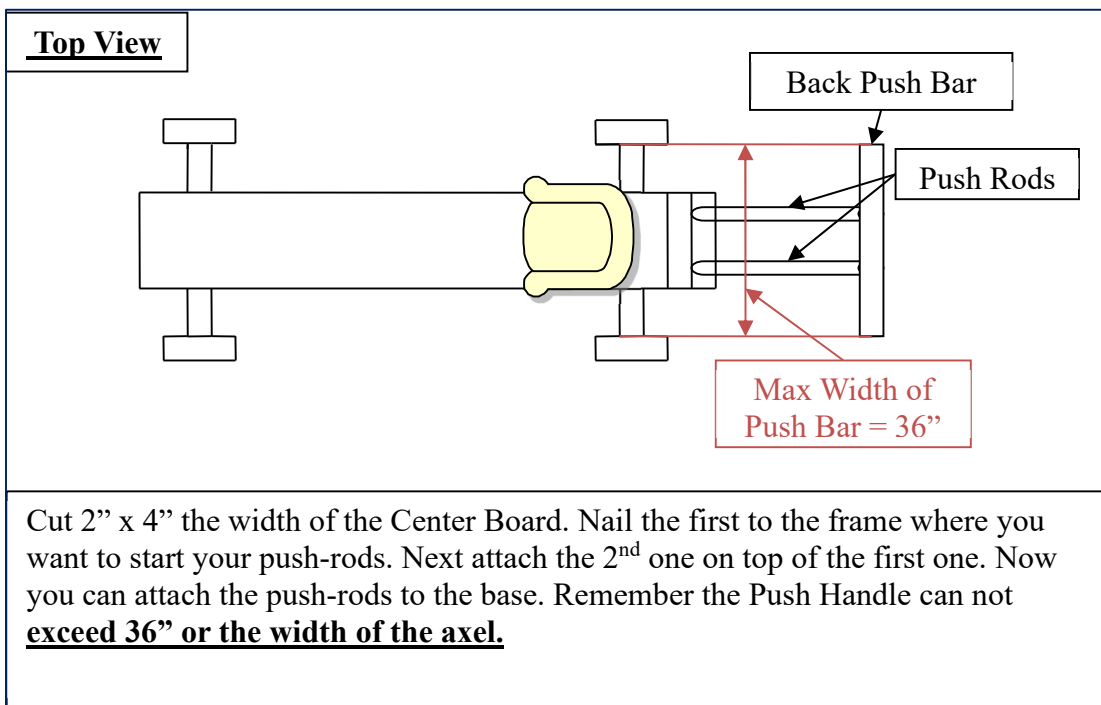

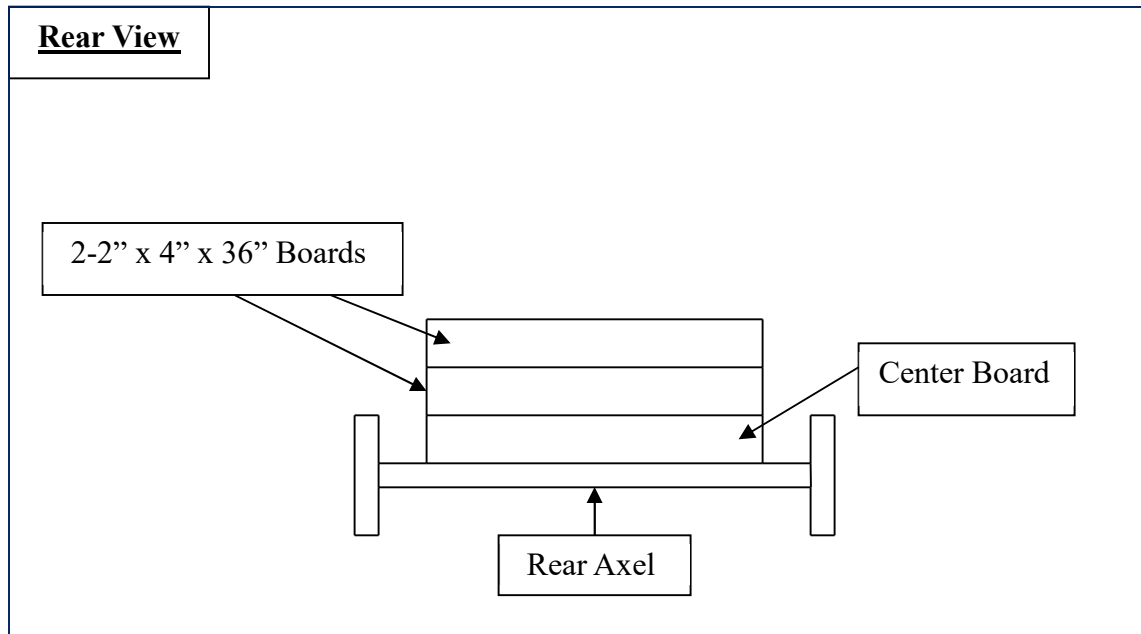

11. Make (2) Push Rods or single frame that can be placed on the rear of the Center Board. They can be permanently mounted to the frame or made removable when transporting to the campout. If making the 2-Push Rods drill a 1" hole through the 2-long 2" x 4" x ?" boards and insert a 1" dowel rod through the holes. After spacing the dowel rod between the 2-2" x 4"s drill a small hole on both sides of the dowel rod and insert some type of holding item that will keep the dowel rod from sliding back and forth during the race. If you prefer another way at the end of the 2 long 2" x 4" x ?", you can take another piece of wood and attach it across the ends of the Push Rods. Remember that the Push Handle cannot exceed 36" or the width of the axel. The axel is also 36" but it can be less.



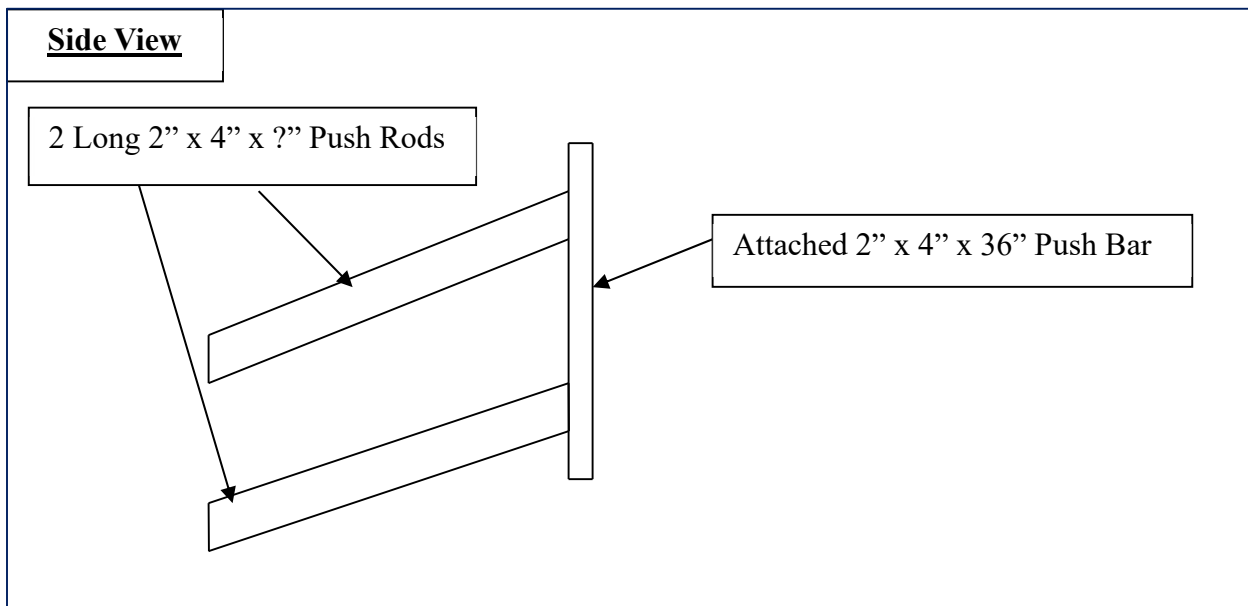
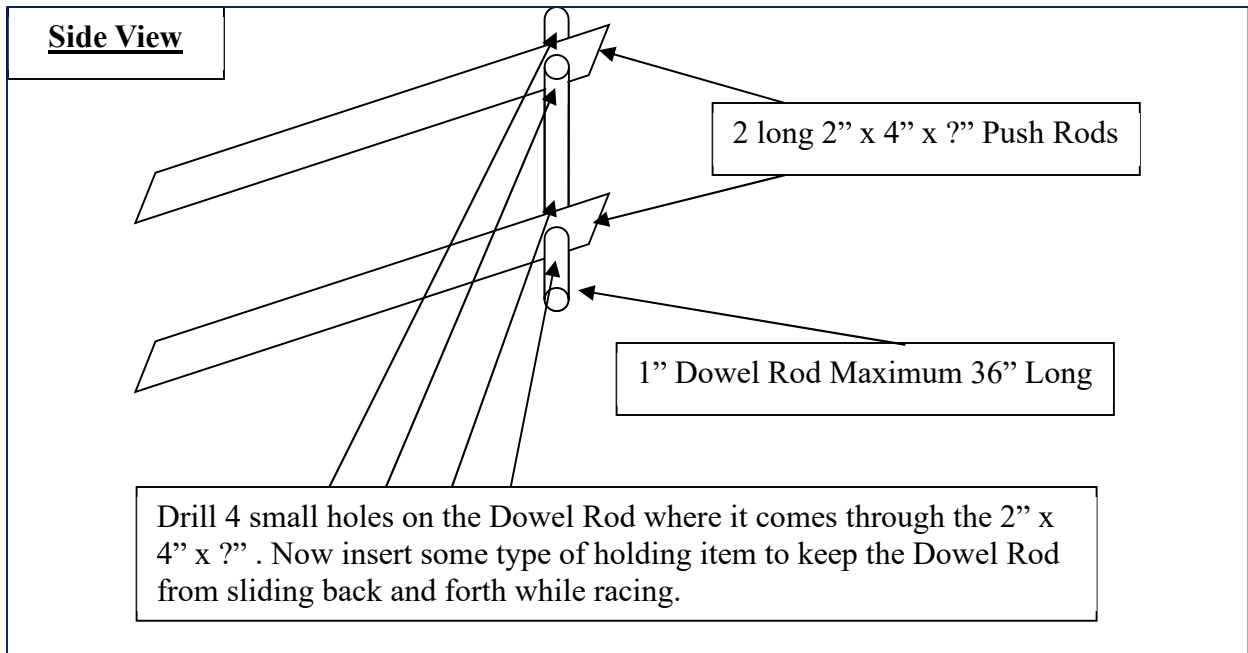

12. The pulling of lashbox derby cars is prohibited during the race. This is a safety issue and will be strictly enforced.

## This Should Resemble Your Lash Box Derby Race Car

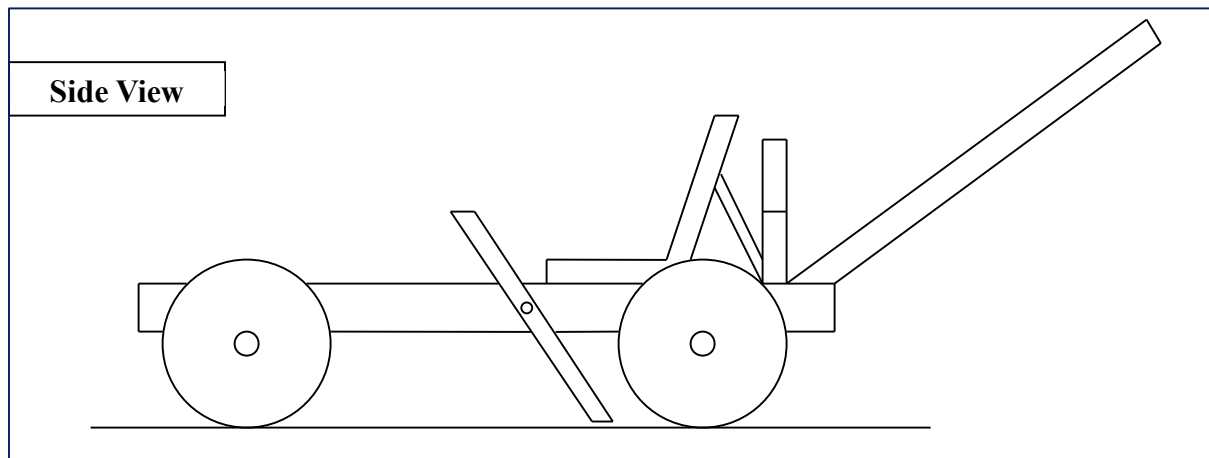

\*Remember that you are pushing your car for power.

\*The driver must wear the seatbelt whenever the car is in motion.

\*The driver MUST always WEAR a safety helmet while driving the car. Helmets that can be used are motorcycle helmets, bicycle helmets, football or lacrosse helmets. See illustrations below.

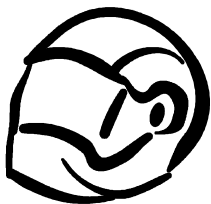

Motorcycle Helmet



Football or Lacrosse Helmet



Bicycle Helmet

A very important message to all Scouts to remember after the races are done is to shake the hands of the other drivers, as this is a sign of good Sportsmanship. There will be a 1<sup>st</sup> 2<sup>nd</sup> /3<sup>rd</sup> place winners will receive ribbons. Build your car with Webelos pride, and as you paint your car put your Pack # and Patrol Name on it.

\*Note to all participating, including parents and leaders of those participating, in the “Lash Box Derby”. When cheering on racers please be respectful to everyone by not being aggressive or mean. Remember this is just a fun race, so relax and have fun. In addition, all results are recorded with appropriate care but may not be to the exact second. Results as recorded are final. The winners of the “Lash Box Derby” are based on the fastest 3 times recorded after every Webelos Unit has had the chance to race twice. The winners are picked by the Troop/Crew running the event and it is up to their discretion. Generally, the winners are based on the fastest times, however, bad sportsmanship of Scouts or Adults can be grounds for Lash Box Derby disqualification regardless of time recorded.