

Balsa Machining Service's

School Rocket Kit

Flying Model Rocket Assembly Instructions



Balsa Machining Service
3900 S. Winchester Ave.
Pahrump, NV 89048
775-537-6232

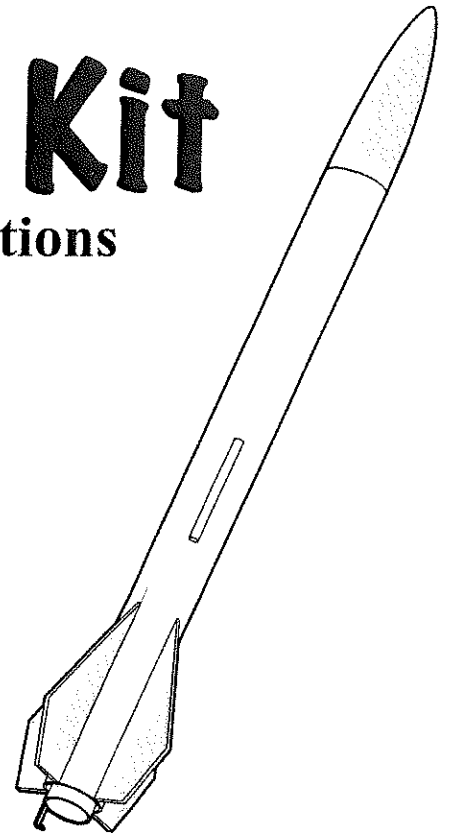

Additional Supplies You'll Need To Complete this Kit:

White or Yellow Glue:

Use Titebond, Elmer's Carpenter's Wood Glue or Elmer's White School Glue.

Transparent Tape:

Use Transparent tape such as Scotch Tape or other comparable brands.

Stapler:

Common manual stapler.

Finishing Supplies (Optional):

Spray Paint and Sand Paper.

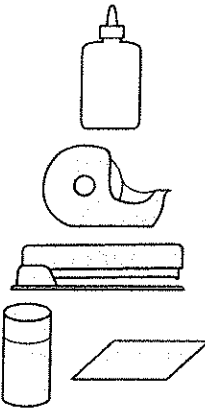

Inventory all parts and acquire any missing ones. You should have:

- A. Launch lug
- B. Four fins
- C. Engine mount tube
- D. Engine stop block
- E. Centering rings, 2
- F. Nose cone
- G. Metal screw eye
- H. Wood dowel
- I. Engine hook
- J. Body tube
- K. Shock cord
- L. Streamer

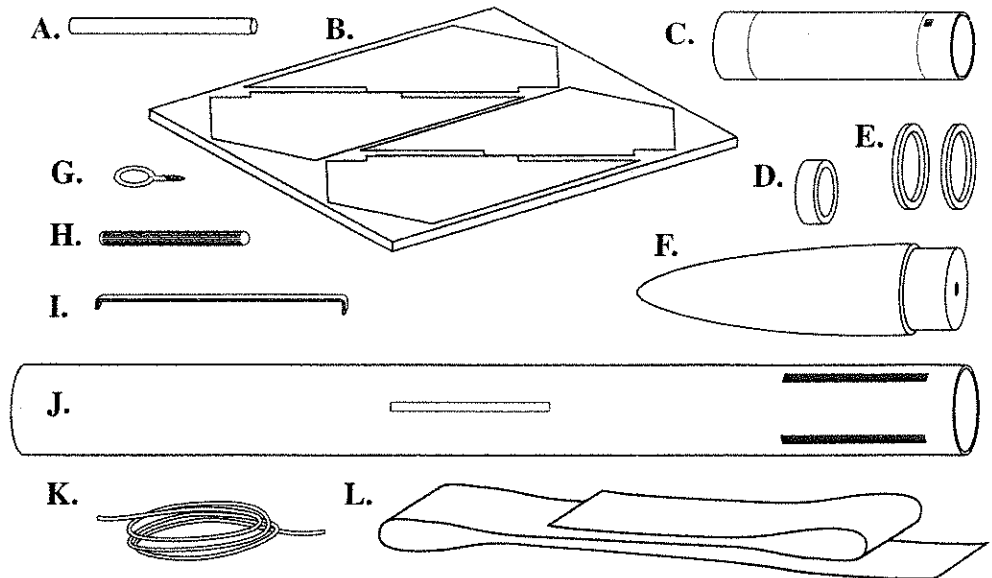

Step 1. Locate the two *centering rings*, *engine hook* and *engine mount tube*. Position the *engine hook* against the *engine mount tube* with one end of the *hook* through the *small slit* in the *tube*. Carefully, so you do not wrinkle the *engine mount tube*, slide one of the *centering rings* over the *hook* and outside of the *tube* and slide it until it is close to the middle of the *tube*. Slide the other *centering ring* over the *engine mount tube* and *hook* and slide it close to the middle.

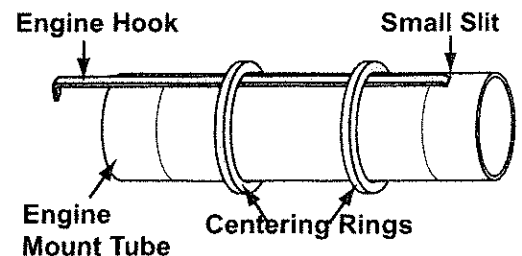

Step 2. Push one end of the *shock cord* (the yellow string) through the *small square hole* in the *engine mount tube* and pull about three inches of the *shock cord* through the opening.

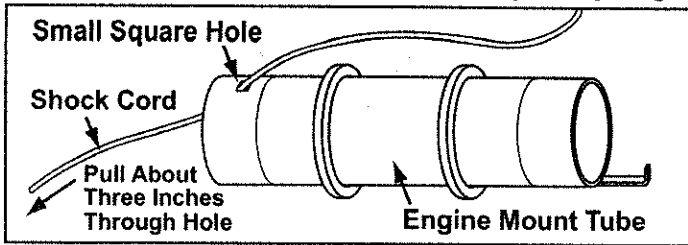

Step 3. Starting at the end with the *small square hole*, put a ring of glue inside the *engine mount tube*. Make sure to leave the *shock cord* in the *tube*.

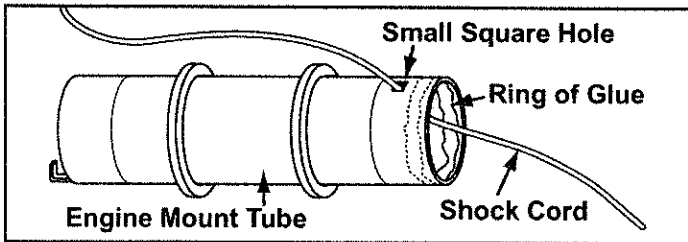

Step 4. Push the *engine stop block* into the ring of glue inside the *engine mount tube* making sure it stops even with the end of the *tube*. The *shock cord* should also be through the center of the *engine stop block*.

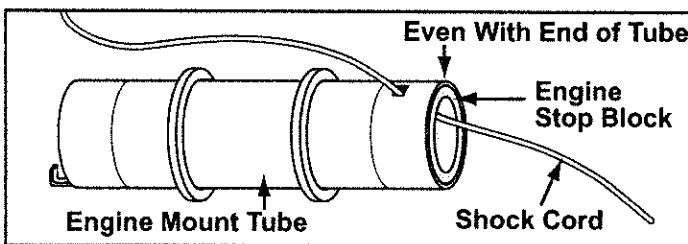

Step 5. Hold the short end of the *shock cord*. Loop it around the other part of the *shock cord* and tie several knots in it. Pull on the long end of the *shock cord* to make sure the knots are tight and that the *cord* is firmly attached to the *engine mount tube*. When you are through tying the knots, you should not have much of the short end of the *shock cord* dangling loose from the *engine mount tube*.

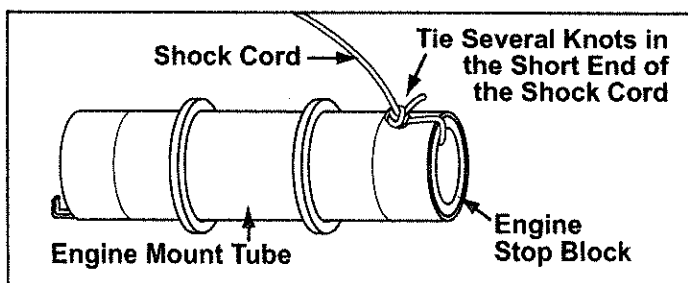
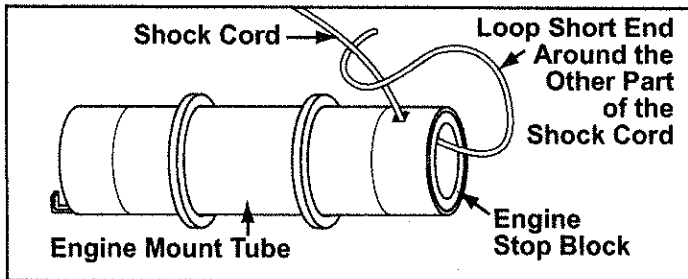

Step 6. Put a small amount of glue around the *engine mount tube* on one of the *laser scribed lines*. Slide the *centering ring* until it is over the glue.

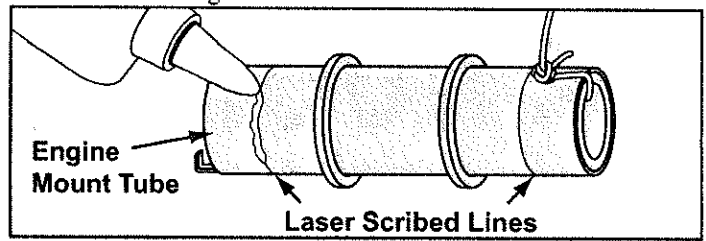

Step 7. Put a small amount of glue around the *engine mount tube* on the other *laser scribed line* and slide the remaining *centering ring* over the line.

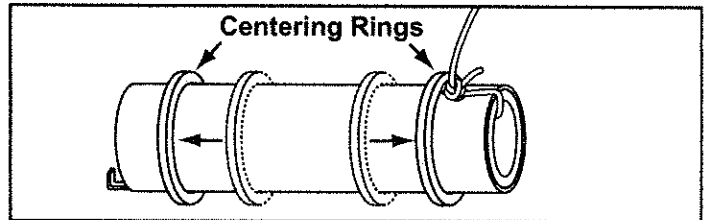

Step 8. Tie the loose end of the *shock cord* to the *metal screw eye*. Tie the knots close to the end of the *shock cord* so that you do not have much excess *cord* hanging. Tie at least three tight knots.

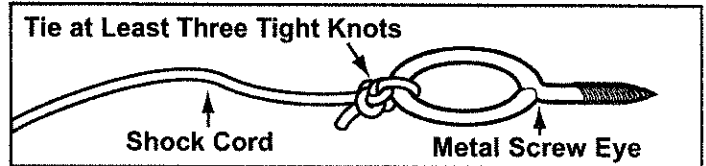

Step 9. Write your name on the *streamer*.

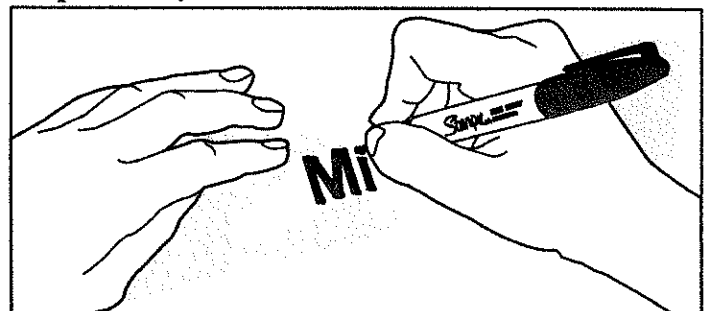

Step 10. Holding the *body tube* upside down, with the laser cut slots on the top, drop the *metal screw eye* through the *body tube* so that the *screw eye* ends up hanging out of the other end of the *body tube*.

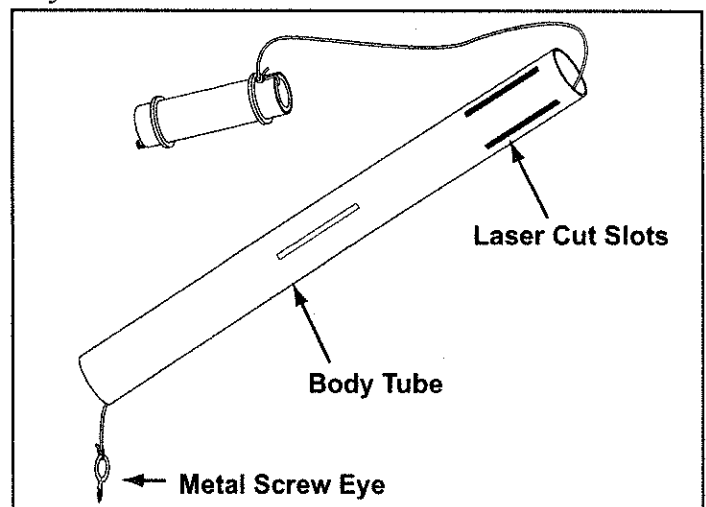

Step 11. You will now be installing the *engine mount assembly* and you need to work quickly so the glue does not dry before you have completely installed it. Place the glue bottle tip inside the *body tube* in the end with the *laser cut slots* and put a small ring of glue up inside the *tube*. Insert the *engine mount assembly* part way in. Quickly put another ring of glue in the *body tube* close to the end and push the *engine mount assembly* inside the *body tube* until about $\frac{1}{4}$ " of the *engine mount tube* is extending out of the end of the *body tube*. Wipe any glue out of the slots. Be sure that neither *centering ring* is in the slots.

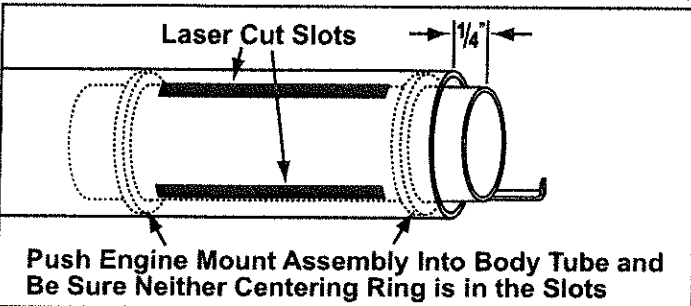
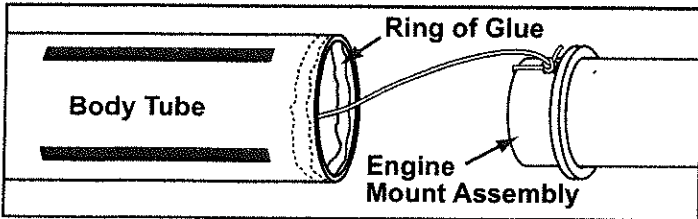

Step 12. Apply a thin strip of glue, no wider than about $\frac{1}{2}$ the width of the *fin*, above, on, and below the tab on the *fin*.

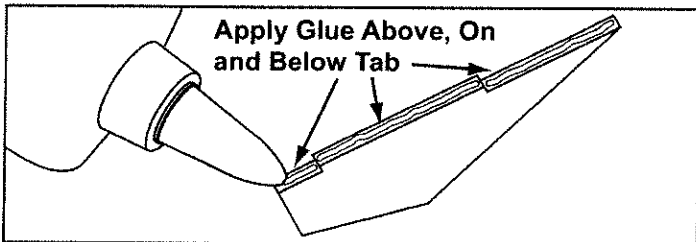

Step 13. Place the glued edge of the *fin* in one of the *laser cut slots*. The *fin* should now be glued flush with the *body tube*.

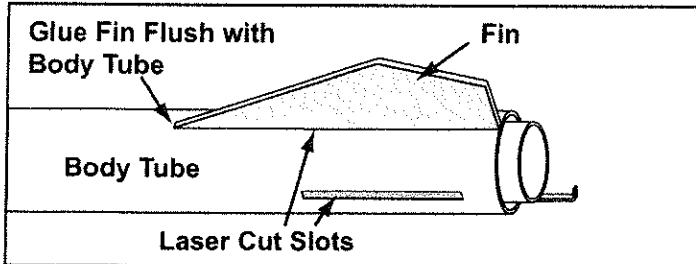

Step 14. Hold the *fin* firmly on for at least one minute and do not bump or move it. The *fin* should be perpendicular to the *body tube* as shown below. Hold the *body tube* horizontally with the *fin* sitting up and wait a minute before continuing.

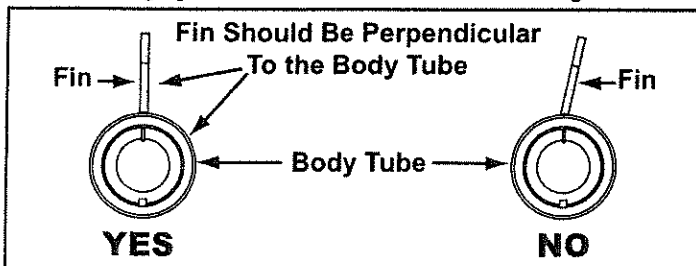

Step 15. Repeat Step 14 for the next three *fins*. Allow time between installations so the glue dries well enough to hold the *fins*. When all four *fins* are on correctly, they should look like the diagram below. Adjust them as needed.

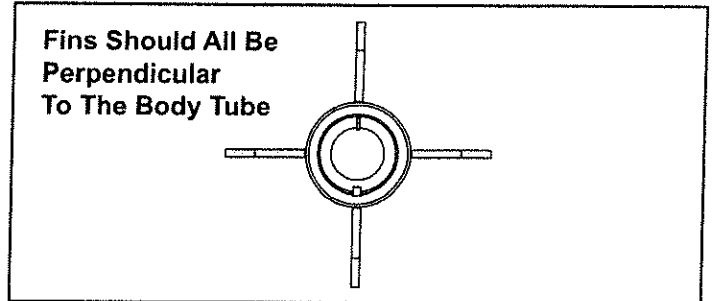

Step 16. Place a thin *fillet* (strip) of glue on each *fin* where it meets the *body tube*. Use your finger to smooth *fillet*. Wipe glue off of finger with damp cloth or paper towel.

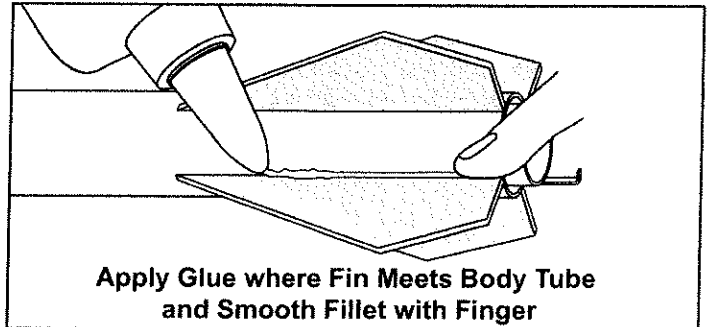

Step 17. Place a thin strip of glue on one side of the *launch lug* and place it on the *laser scribed rectangle* on the *body tube*. When it is placed correctly, the *launch lug* will be parallel with the *body tube* as shown.

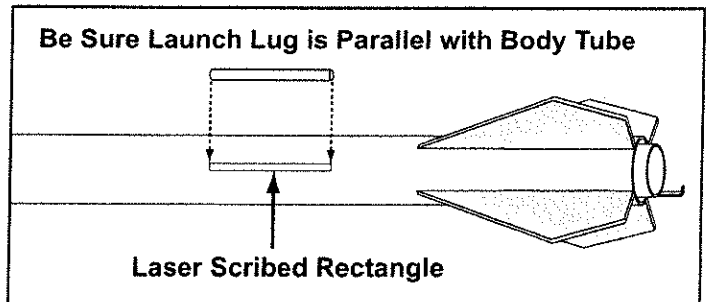

Step 18. Locate the $\frac{1}{4}$ " diameter *wood dowel* and thread the *screw eye* into the end of the *dowel* with the pre-drilled *pilot hole*. Place a liberal amount of glue on the *dowel* and insert into *hole* in base of *nose cone*. Wipe off any excess glue.

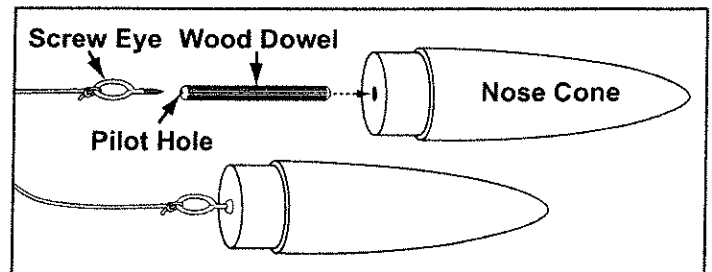

Step 19. Lay the *streamer* on a desk or table. Place the *shock cord* over the *streamer* so it is about one inch from the end of the *streamer*. There should be about six inches between the *nose cone* and *streamer*. Tape the *streamer* to the *shock cord* using transparent tape.

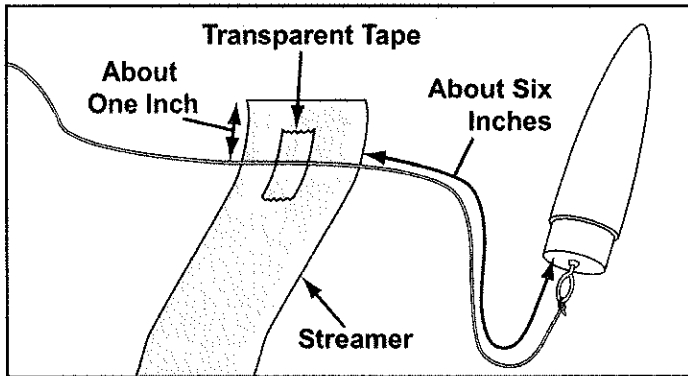

Step 20. Fold the one-inch section of the streamer over the shock cord and staple it in two places.

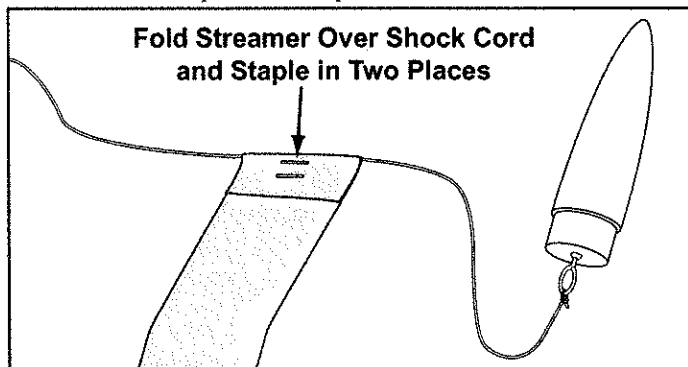

Step 21. Carefully fold the streamer in half and then fold it again. Roll the remaining portion tightly and place it inside the body tube. Put the remainder of the shock cord in the body tube and carefully push the nose cone in the tube. Avoid pinching the shock cord between the nose cone and the body tube.

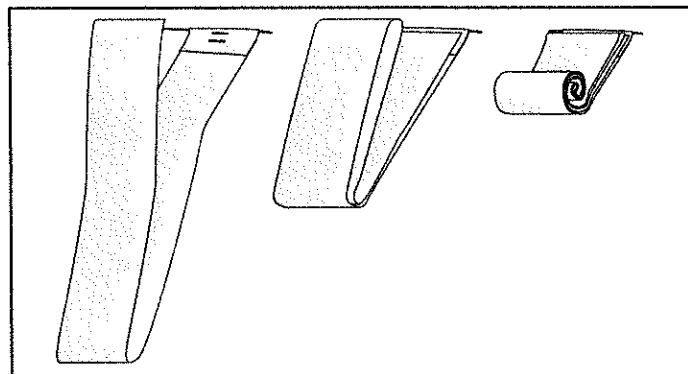

Step 22. Verify that the glue holding the fins and launch lug on is dry. Select a color and spray paint the rocket. After the paint is dry, make sure the nose cone will pull out of the body tube relatively easy. If it is too tight, lightly sand the nose cone where it fits inside the tube.

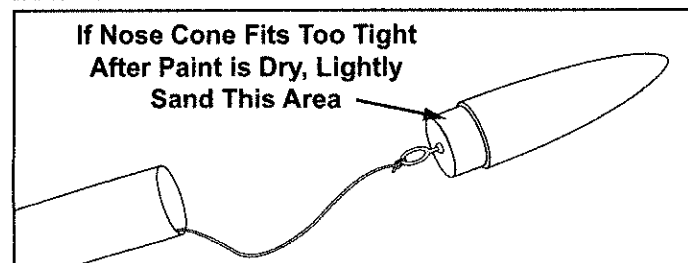

Step 23. Obey and follow the N.A.R Model Rocket Safety Code and have fun, but most of all be safe when launching and recovering your rocket.

N.A.R. MODEL ROCKET SAFETY CODE

Approved February 10, 2001

1. **MATERIALS.** I will use only lightweight, non-metal parts for the nose, body, and fins of my rocket.
2. **MOTORS.** I will use only certified, commercially-made model rocket motors, and will not tamper with these motors or use them for any purposes except those recommended by the manufacturer.
3. **IGNITION SYSTEM.** I will launch my rockets with an electrical launch system and electrical motor igniters. My launch system will have a safety interlock in series with the launch switch, and will use a launch switch that returns to the "off" position when released.
4. **MISFIRES.** If my rocket does not launch when I press the button of my electrical launch system, I will remove the launcher's safety interlock or disconnect its battery, and will wait 60 seconds after the last launch attempt before allowing anyone to approach the rocket.
5. **LAUNCH SAFETY.** I will use a countdown before launch, and will ensure that everyone is paying attention and is a safe distance of at least 15 feet away when I launch rockets with D motors or smaller, and 30 feet when I launch larger rockets. If I am uncertain about the safety or stability of an untested rocket, I will check the stability before flight and will fly it only after warning spectators and clearing them away to a safe distance.
6. **LAUNCHER.** I will launch my rocket from a launch rod, tower, or rail that is pointed to within 30 degrees of the vertical to ensure that the rocket flies nearly straight up, and I will use a blast deflector to prevent the motor's exhaust from hitting the ground. To prevent accidental eye injury, I will place launchers so that the end of the launch rod is above eye level or will cap the end of the rod when it is not in use.
7. **SIZE.** My model rocket will not weigh more than 1500 grams (53 ounces) at liftoff and will not contain more than 125 grams (4.4 ounces) of propellant or 320 N-sec (71.9 pound-seconds) of total impulse. If my model rocket weighs more than one pound (453 grams) at liftoff or has more than 4 ounces (113 grams) of propellant, I will check and comply with Federal Aviation Administration regulations before flying.
8. **FLIGHT SAFETY.** I will not launch my rocket at targets, into clouds, or near airplanes, and will not put any flammable or explosive payload in my rocket.
9. **LAUNCH SITE.** I will launch my rocket outdoors, in an open area at least as large as shown in the accompanying table, and in safe weather conditions with wind speeds no greater than 20 miles per hour. I will ensure that there is no dry grass close to the launch pad, and that the launch site does not present risk of grass fires.

LAUNCH SITE DIMENSIONS

Installed Total Impulse (N-sec)	Equivalent Motor Type	Minimum Site Dimensions (ft)
0.00 - 1.25	1/4A, 1/2A	50
1.26 - 2.50	A	100
2.51 - 5.00	B	200
5.01 - 10.00	C	400
10.01 - 20.00	D	500
20.01 - 40.00	E	1,000
40.01 - 80.00	F	1,000
80.01 - 160.00	G	1,000
160.01 - 320.00	Two G's	1,500

10. **RECOVERY SYSTEM.** I will use a recovery system such as a streamer or parachute in my rocket so that it returns safely and undamaged and can be flown again, and I will use only flame-resistant or fireproof recovery system wadding in my rocket.
11. **RECOVERY SAFETY.** I will not attempt to recover my rocket from power lines, tall trees, or other dangerous places.



Balsa Machining Service
 3900 S. Winchester Ave.
 Pahrump, NV 89048
 775-537-6232

